

BWT Desinfecton X & S Operating Instructions



Table of Contents

1	Preface	5
1.1	General	5
1.1.1	Standards and Certification	5
1.1.2	Target Group for Operating Instructions	5
2	Definitions	6
2.1	Abbreviations	6
2.2	Notifications and Icons/Pictograms	7
3	Signs and Markings on BWT Desinfector	8
3.1	Marking Plate/Machine Type Plate	8
3.2	Safety Signs	9
4	Description of BWT Desinfector	10
4.1	EC-Declaration of Conformity/Declaration of Incorporation	12
4.2	Function Description	13
4.3	Technical Specifications	14
4.4	Product Warranty	15
4.5	Use of BWT Desinfector	15
4.5.1	User Requirements and Limitations	15
4.5.2	Intended Use	16
4.5.3	Unintended Use	16
5	HMI Controller	17
5.1	Overview	17
5.2	Functions	18
5.2.1	Start Screen (Logo)	18
5.2.2	Operation Screen	19
5.2.3	Menu	20
5.2.4	Flowchart	21
5.2.5	Information	22
5.2.6	Trends	22
5.2.7	Language	22
5.2.8	Settings	23
5.2.9	Communication	23
5.2.10	Configuration	26
5.2.11	Dosing	27
5.2.12	Proportional Dosing	28
5.2.13	ORP Application	29
5.2.14	Softener settings	32
5.2.15	Installing New Cell	35

5.2.16	Manual Operation.....	35
5.2.17	Buffer tank.....	36
6	Handling, Installation, Connection, and Testing	37
6.1	Handling and Lifting Instructions.....	37
6.2	Storage Before Installation	37
6.3	Installation	38
6.3.1	Installation Safety Instructions.....	39
6.3.2	Installation Procedure.....	39
6.3.3	Attachment to Mounting Rack	40
6.3.4	Peristaltic Pumps.....	41
6.4	Connection to Supply Sources.....	42
6.4.1	Safety When Connecting.....	42
6.4.2	Water Supply Connection.....	43
6.4.3	Electrical Supply Connection.....	45
6.4.4	Neuthox® Tank Connection	46
6.4.5	Dosing Pump Installation on BWT Desinfector.....	47
6.4.6	ORP Hot Water Supply Hardware Installation.....	49
6.4.7	Proportional Dosing Hardware Installation	51
6.5	Commissioning by Installer.....	52
6.5.1	Manual Operation.....	52
6.5.2	Safety at Commissioning.....	55
6.5.3	Commissioning Procedure	55
7	Safety	59
7.1	Residual Risks.....	60
8	BWT Desinfector Operation.....	61
8.1	Information During Operation.....	61
8.1.1	Visual Information/Warnings.....	61
8.2	Normal Operation	61
8.2.1	Switching on Electric Supply	61
8.2.2	Neuthox® Production Process	61
8.3	Consumables.....	61
8.3.1	Salt	61
8.3.2	Water Softener Cartridge.....	62
8.4	Machine and Work Area - Order and Cleaning.....	62
8.5	Safety During Normal Operation.....	62
8.5.1	Test of Safety Functions.....	62
8.5.2	Startup After Normal Stop	63
8.5.3	Startup After Service/Repair.....	63
8.6	Service, Repair and Maintenance.....	63

8.7	Troubleshooting	64
8.7.1	Process	64
8.7.2	Dosing	65
9	Storage/Scrapping of BWT Desinfecton	66
9.1	Storage of Neuthox®	66
9.2	Dismantling	66
9.2.1	Safety When Dismantling	66
9.3	Transportation.....	66
9.4	Scrapping of the BWT Desinfecton and Neuthox®	67
10	Appendix 1 – Modbus	68
10.1	Remote start and stop	68
10.2	MI2519 – Neuthox® production process status	69
10.3	MI2540 – Neuthox® dosing status	70
11	Appendix 2 – Documentation	70
11.1	BWT Documentation.....	70
11.2	3 rd Party Documentation	70

1 Preface

1.1 General

This is the original instruction manual for the BWT Desinfector. BWT Desinfector is designed and manufactured for use by sufficiently trained operators. It is necessary to read the instructions before installing or using the BWT Desinfector for the first time. It may be necessary to continually re-read to maintain knowledge and skills. If the safety instructions are not followed, it might lead to personnel injury and result in loss of any claims for damages.

Emphasis is placed on the safe and proper use of the equipment. The Operating Instructions contain information regarding, or references to, all stages of BWT Desinfector lifecycle and all the relevant safety measures, from transportation, assembly, commissioning, operation, failures to decommissioning. It also includes relevant contact information, warranty/service specifications, and proper safe usage.

The Operating Instructions offer a basic introduction to the design, function, and proper operation. In addition, they contain important notes for safe handling and proper installation, only to be performed by a sufficiently trained installer. The texts, photos and graphic images are kept general to ensure a high level of clarity.

1.1.1 Standards and Certification

These operating instructions have been drawn up based on the Machinery Directive 2006/42/EC, EN ISO 12100: 2011 (6.4.5) & EN ISO 20607: 2019.

1.1.2 Target Group for Operating Instructions

The Operating Instructions are aimed at personnel with the necessary qualifications, skills, and training to install and operate the BWT Desinfector, more specifically:

- Installation technician: Must be sufficiently qualified/skilled to install the BWT Desinfector. Shall adhere to local standards in regard to the electrical and hydraulic installation and must have thoroughly read the Operating Instructions before installing the BWT Desinfector.
- Operator: Must be fully informed about the workings of the BWT Desinfector and must have thoroughly read the Operating Instructions before using the BWT Desinfector for the first time with emphasis on the safety instructions in the manual.
- Maintenance and service personnel: Must be service technicians from BWT or collaboration partners specialized in the workings of the BWT Desinfector.

2 Definitions



This manual is written in a simple and easy to understand language.



There may be technical terms that do not immediately make sense or can be hard to remember. The list in this section should help to prevent misunderstandings.



2.1 Abbreviations

Abbreviation	Expression	Definition
BWT	Best Water Technology	Company name
ECA	Electrochemically Activated Water	ECA water effectively eliminates all types of microorganisms
EMC	Electromagnetic Compatibility	The ability of electrical equipment and systems to function acceptably in their electromagnetic environment
FAC	Free Available Chlorine	A measure of chlorine in these two chemicals is known as Free Available Chlorine (FAC). These compounds are available to oxidize contaminants in pool water
HMI	Human Machine Interface	Machine interface. Operator can start, set, or stop functions
ORP	Oxidation Reduction Potential	A measure of a substance's ability to either oxidize or reduce another substance
P&I	Piping and instrumentation diagram	A detailed diagram which shows the piping and process equipment together with the instrumentation and control devices
PCB	Printed Circuit Board	A medium used to connect or "wire" components to one another in a circuit
PLC	Programmable Logic Controller	Alternate naming for HMI Controller
PPM	Parts Per Million	A measurement of concentration on a weight or volume basis
SIM card	Subscriber Identity Module	A smart card that stores identification information that pinpoints a smartphone to a specific mobile network
SMS	Short Message Service	A text messaging service component of most telephone, internet, and mobile device systems

2.2 Notifications and Icons/Pictograms

	NOTICE	
<p>General information that should be read before using the BWT Desinfector.</p>		

	CAUTION	
<p>Safety related information. Inattention can result in malfunction or damage to the BWT Desinfector or installation!</p>		

	WARNING	
<p>Safety related information. Inattention can result in serious injuries!</p>		

3 Signs and Markings on BWT Desinfector

3.1 Marking Plate/Machine Type Plate

The CE marking plate is located on the side of the BWT Desinfector cabinet. The marking plate must not be removed and must be replaced if it is missing or damaged, to a degree where it has become unreadable (Figure 1 and Figure 2).

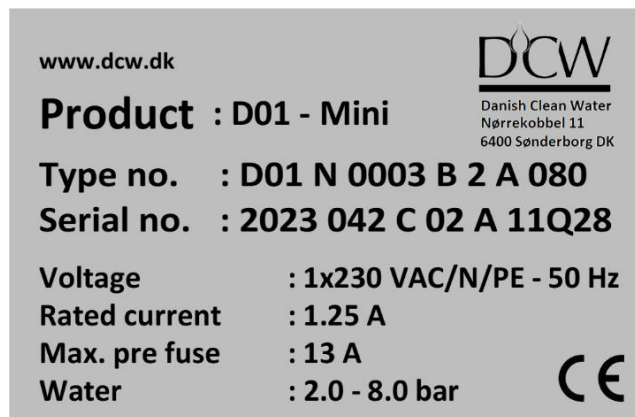







Figure 1 - Location of CE



Figure 2 - Location of CE marking plat

3.2 Safety Signs

The safety-related signs for the BWT Desinfector, as well as their meaning.

Pictogram	Definition	ISO reference number
	Warning; General warning	ISO ref.: W001
	Warning; Explosive material	ISO ref.: W002
	Warning; Toxic material	ISO ref.: W016
	Warning; Flammable material	ISO ref.: W021
	Warning; Corrosive substance	ISO ref.: W023
	Prohibited; No smoking or open flames near equipment	

4 Description of BWT Desinfector

The BWT Desinfector produces the disinfectant solution known as Neuthox® on-site through an electrochemical process (the electrolysis of salt and water), during which hypochlorous acid is produced.

The BWT Desinfector comes in 2 different tank configurations depending on the machine's production capacity:

- Configuration 1: Internal tanks
- Configuration 2: External tanks for brine and Neuthox, 33 L

Besides the tank-size differences, configurations 2 differ from configuration 1 in regard to salt filling, where there is no need to open the cabinet in order to fill salt in the brine tank on configurations 2. Configurations 2 also have external hoses and cables routed between the BWT Desinfector and the external tanks (Figure 3 and Figure 4).

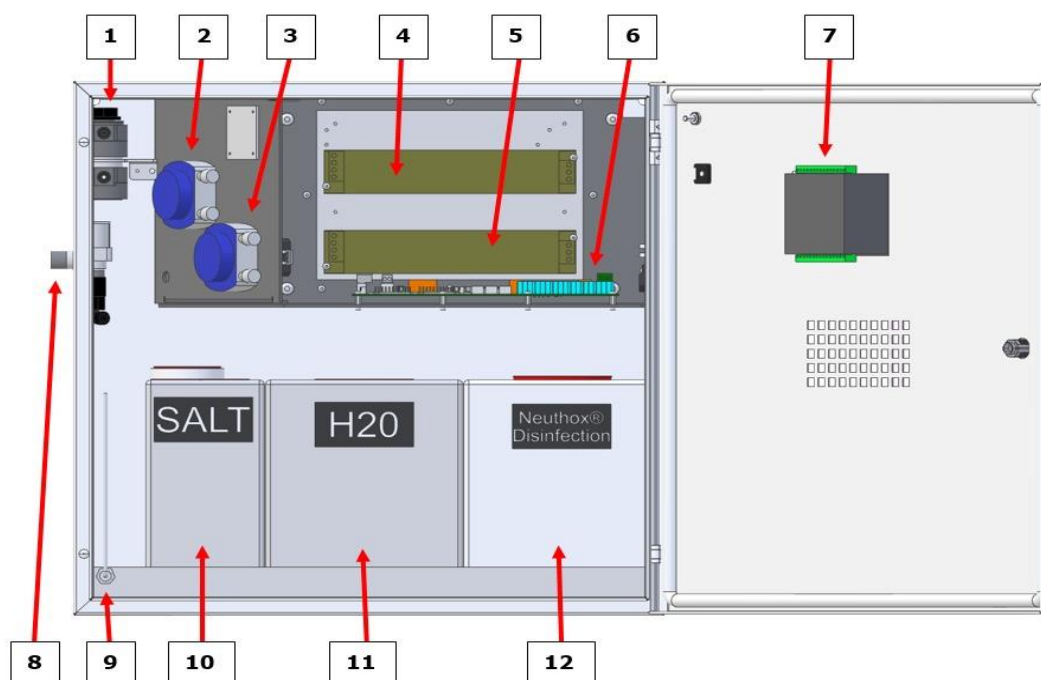

Figure 3 - Overview of configuration 1

1	Cell
2	Brine pump
3	Water pump
4	Cell transformer
5	PLC transformer
6	PCB connection board

7	PLC
8	Water inlet valve
9	Leak sensor
10	Salt/brine tank
11	Soft water/H2O tank
12	Neuthox® Disinfection tank

The soft water tank is placed inside the cabinet in all BWT Desinfecton configurations, and the soft water tank is connected to the brine tank. The BWT Desinfecton comes standard without salt in the brine tank.

There are the following level sensors in all three tanks (Figure 5):

- The level sensor in the soft water tank, which is connected to the NI01 plug (1) on the PCB.
- The level sensor in the brine tank, which is connected to the NI02 plug (2) on the PCB.
- The leak sensor in the bottom of the cabinet, which is connected to the NI03 plug (3) on the PCB.
- The level sensor in the Neuthox[®] tank, which is connected to the NI04 plug (4) on the PCB.

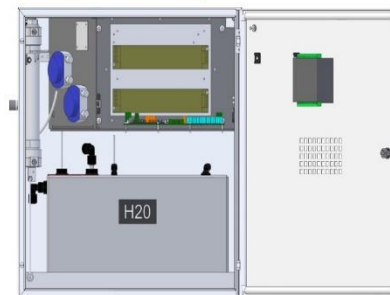

Figure 4 - Configuration 2

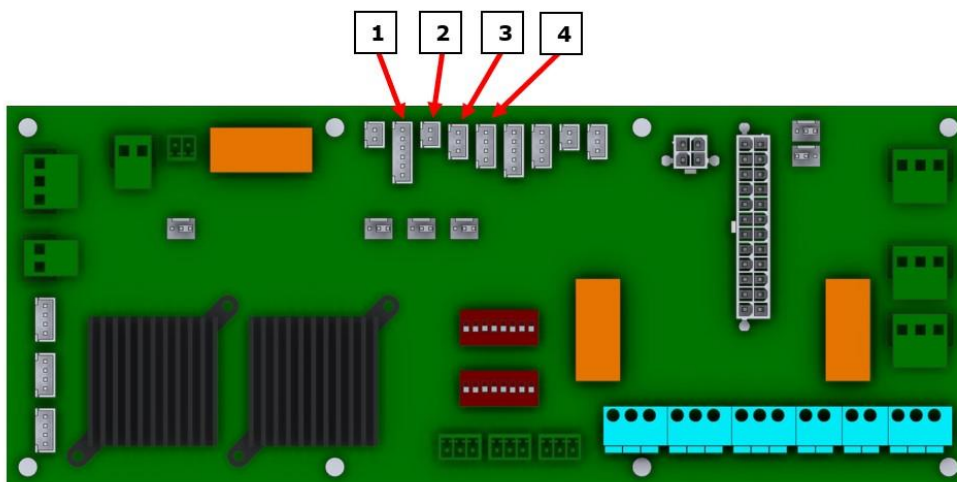

Figure 5 - Level sensor configuration on PCB

1	Water tank (NI01)
2	Brine tank (NI02)
3	Leak sensor (NI03)
4	Neuthox [®] tank (NI04)

4.1 EC-Declaration of Conformity/Declaration of Incorporation



Manufacturer:
Danish Clean Water A/S

Generator:
Product Description : Electrolytic Disinfectant Generator
Type : DCW Mini – D01

We hereby declare that the above mentioned product meet the Machinery Directive regarding 2006/42/EU starting from December 29, 2009 and was manufactured in conformity with the following national standards and the harmonized standards.

2006/42/EU : Machinery Directive
2014/35/EU : Low voltage directive
2014/30/EU : EMC Directive

Issued by : Danish Clean Water A/S

Date : 20. February 2023

Signature:

Håvard Clausen
CEO, managing director

4.2 Function Description

A simplified P&I diagram shows the process: Soft water enters the tank in the BWT Desinfector from an external water softener where the water hardness is removed. The soft water is pumped with a precise flow to the cell and brine is mixed into the water before it enters the electrolysis cell. What makes Neuthox[®] special is that all the fluid is exposed to both sides of the cell. First the fluid passes the negative cathode and afterwards the positive anode. By never splitting the flow, the risk of creating chlorine gas is eliminated. Furthermore, the final product is 8.5 pH, which is close to pH neutral.

The production process is carefully controlled by the build-in HMI controller to supply a uniform product with the lowest possible residual chlorides, all the time (Figure 6).

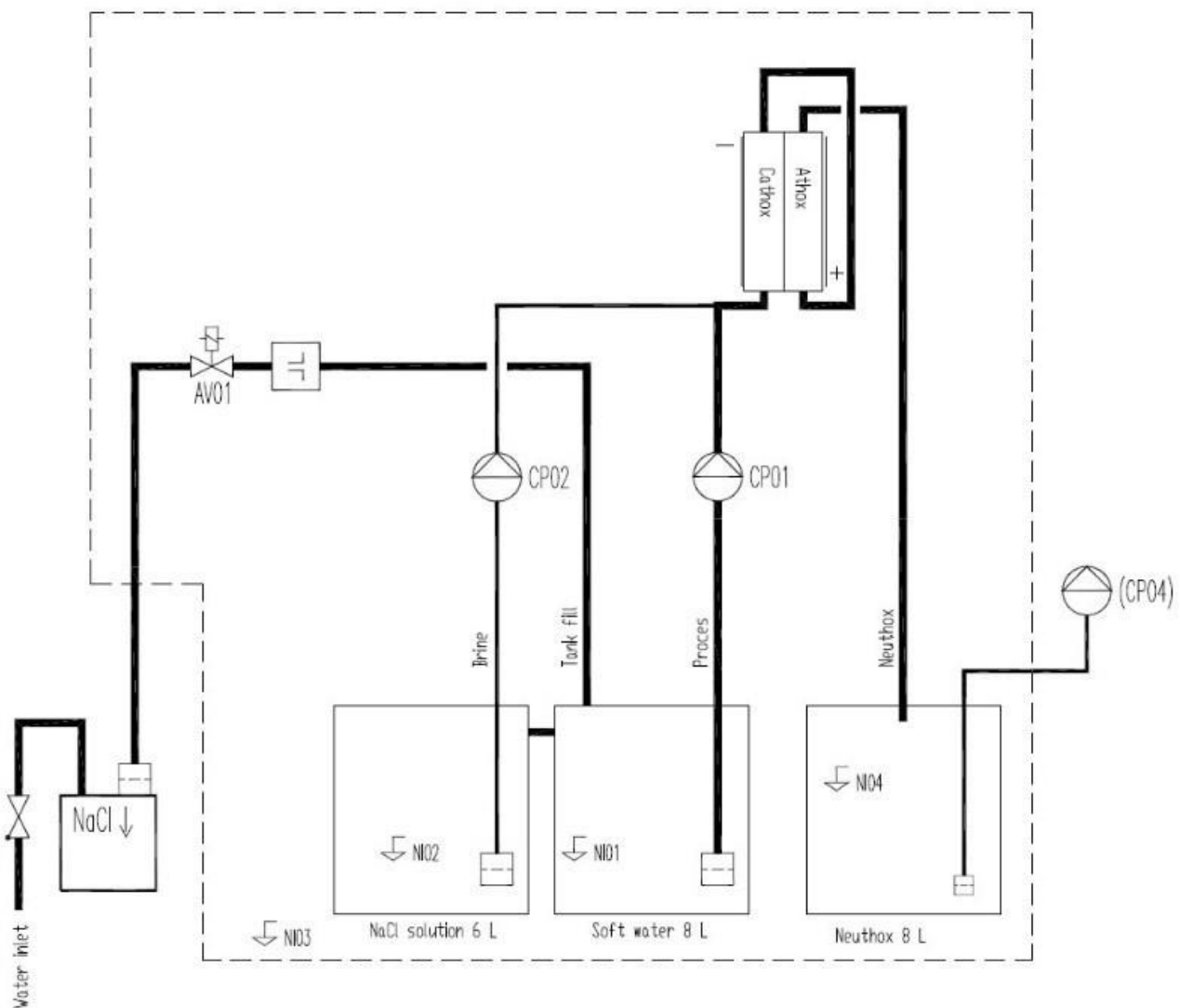

Figure 6 - P&I diagram

4.3 Technical Specifications

BWT Desinfecton Specifications	Unit	3LC internal tanks	3LC external tanks	9LC	15LC
Neuthox® production capacity; ±10%	l/h	3	3	9	15
Chloride in Neuthox®; ±10%	ppm	1700			
Free Active Chlorine; ±10%	ppm	500			
pH-value	pH	5,5 - 8,5			
Approx. NaCl consumption	Kg/day	0,15		0,45	0,75
Max. pre-fuse	A	13			
Power consumption	W	108		324	396
Power supply; ±10%	V, Hz	230VAC, 50Hz			
Protection class, electrical cabinet	IP	IP54, NEMA3R			
Required water supply pressure	Bar	2,0 – 8,0			
Water supply temperature	°C	≤ 20			
Ambient temperature tolerance	°C	+5 to +40			
Min. required room ventilation	m³/h	2		7	8
Maximum running hours	h/day	24			
Water connection	mm	10 (push-in connector)			
Neuthox® connection	mm	6 (push-in connector)			
BWT Desinfecton Dimensions	Unit	3LC internal tanks	3LC external tanks	9LC	15LC
Cabinet dimensions (WxHxD)	mm	600x600x250			
Weight, dry	kg	22			
Brine tank capacity	kg	9		33	
Neuthox® tank capacity	L	10		33	
Sound level	dB(A)	40			

4.4 Product Warranty

If the safety instructions are not followed, it might lead to personnel injury and result in loss of any claims for damages.

A guarantee claim in accordance with BWT's general terms of sale and delivery is only valid if the following requirements are fulfilled:

- The BWT Desinfector is used in accordance with the information within this manual.
- The BWT Desinfector is not incorrectly handled.
- The maintenance is carried out by authorized and qualified personnel.
- The maintenance interval must be always adhered to.
- Original spare parts are used for repairs during maintenance.

4.5 Use of BWT Desinfector

4.5.1 User Requirements and Limitations

Task and Responsibility Allocation Matrix				
Phase	Tasks (examples)	Executor		
		Operator	Installation technician	Service technician
Transport	- Lifting, loading, and packing	-	X	X
	- Transportation			
	- Unloading and unpacking			
Assembly/ installation and commissioning	- Adjustment of BWT Desinfector	-	X	X
	- Assembly of BWT Desinfector			
	- Connecting to disposal system (Exhaust system, wastewater system)			
	- Connecting to power supply			
	- Mounting onto wall			
	- Preparations for installation			
	- Testing			
- Adjustment and setting of protective devices and other components				
Operation	- Control/inspect production	X	X	X
	- Filling of salt			
	- Minor adjustments and setting of functional parameters			
	- Minor interventions during operation			
	- Restarting after stop			

Service and maintenance	- Adjustments	-	-	X
	- Cleaning			
	- Dismantling/removal of parts and components			
	- Replacement of worn parts			
	- Resetting			
	- Verification of parts and components			
- Disconnecting from supply sources				
Troubleshooting	- Adjustments	-	-	X
	- Dismantling/removal of parts and components			
	- Troubleshooting			
	- Repairing			
	- Replacement of parts and components			
	- Resetting			
- Verification of parts and components				
Scrapping, dismantling, and recycling	- Disconnecting from supply sources	X	X	X
	- Dismantling			
	- Lifting, loading, and packing			
	- Transporting			
	- Unloading			

4.5.2 Intended Use

The intended use of the BWT Desinfector is to produce the disinfection fluid Neuthox® and dosing the Neuthox® into the user's water system.

Neuthox® is used to tackle Legionella, a bacterial disease that can develop in all water piping systems (if they're not correctly maintained) and transfers to humans through inhalation of waterborne vapors. Neuthox® is highly efficient in the destruction of biofilm, germs, and bacteria in both hot and cold water systems. And Neuthox® successfully destroys the above without harming humans or the environment.

4.5.3 Unintended Use

The pure disinfection fluid Neuthox® should not be used, in any situation that it is not intended for or outside the corresponding mixing ration/concentration level.

5 HMI Controller

5.1 Overview

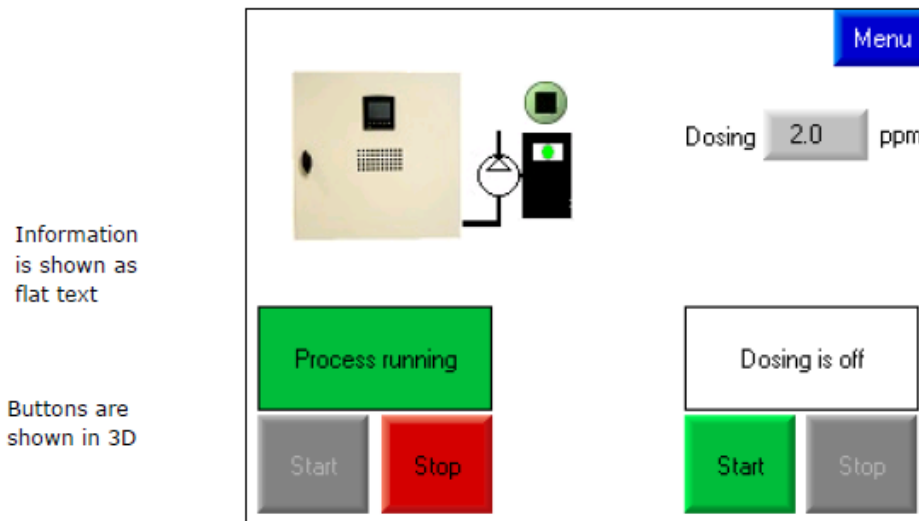

Figure 7 - Overview

The physical buttons below the display are inoperative. All interaction is done using the touch sensitive display.

Information fields changes color in case of an error:

- White if the process is not activated
- Green if the process is activated an OK
- Yellow flashing in case of a non-critical alarm

Red flashing in case of a critical alarm, process will stop.

Inactive buttons are shown in grey with grey writing. If a function button is inactivated, then try stopping the BWT Desinfector to activate it (Figure 8).



Figure 8 - Start button

The Menu button navigates directly to the Menu screen (Figure 9).



Figure 9 - Menu button

The return button navigates to the previous page (Figure 10).



Figure 10 - Return button

Once an input field is pressed, then the on-screen keyboard automatically appears (Figure 11).



Figure 11 - On-screen keyboard

5.2 Functions

5.2.1 Start Screen (Logo)

When the BWT Desinfector is powered on, then the BWT logo is displayed as the start screen. The start screen contains information on the generator size and software version. Pressing the logo will navigate to the operation screen (Figure 12).

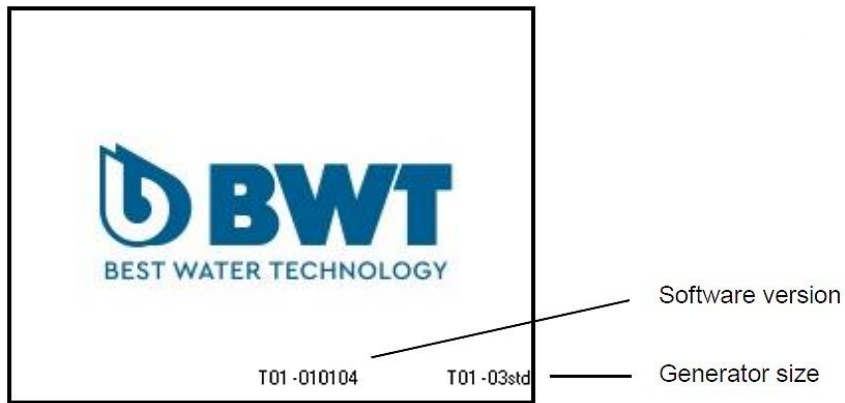

Figure 12 - Start screen

5.2.2 Operation Screen

The operation screen allows the operator to start and stop the process and the dosing, and set the dosing parameter, if dosing is chosen in the configuration.

Depending on the BWT Desinfecton configuration performed by the installer, the operation screen picture will change appearance with dosing either activated or not activated. The operation screen contains one shortcut: BWT Desinfecton cabinet, which navigates directly to flowchart (Figure 13 and Figure 14).

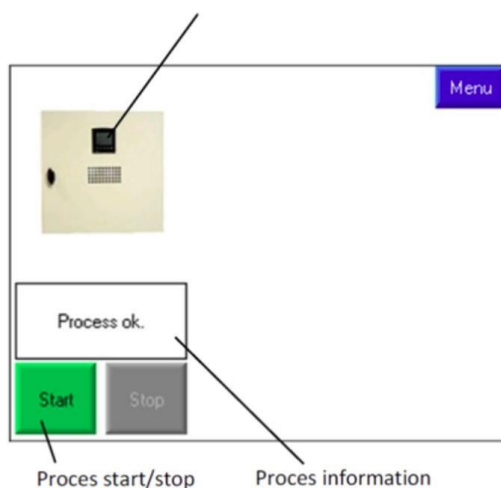

Figure 13 - Operation screen (1) with dosing NOT activated

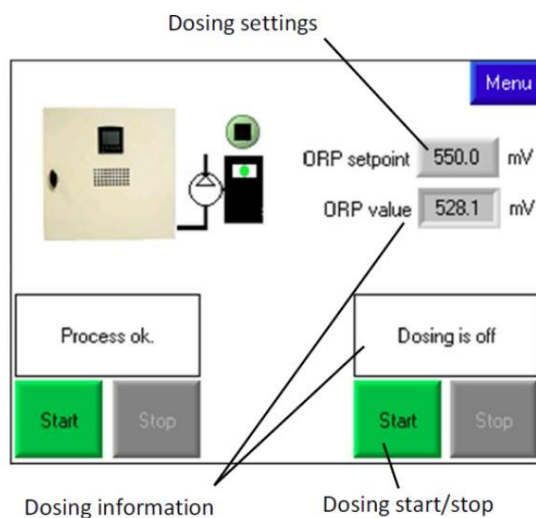

Figure 14 - Operation screen (2) with dosing activated

5.2.3 Menu

Through the menu screen the operator can navigate to all other submenus (Figure 15).

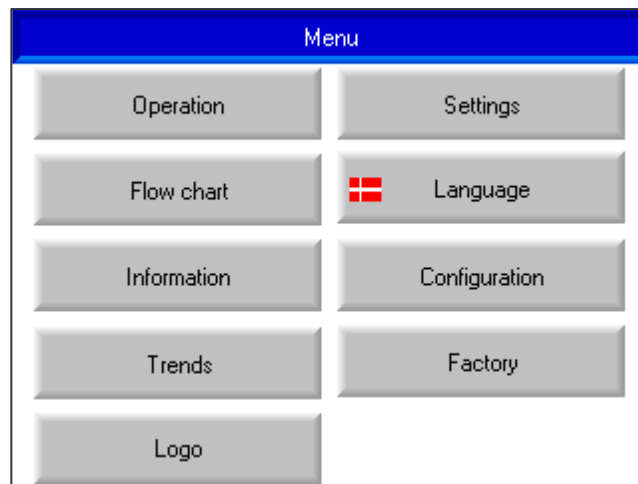

Figure 15 - Submenus

The left function buttons are as follows:

- Operation: Navigates to the operation screen.
- Flowchart: Navigates to a process diagram of the BWT Desinfector.
- Information: Navigates to info screen, where it is visible how much soft water is left, and when the pumps need service.
- If dosing is chosen, the daily water consumption and Neuthox[®] consumption is shown.
- Trends: Navigates to the trend function, where the trend curves for the last 24 hours are shown.
- Logo: Navigates to the start screen.

The possible settings on the BWT Desinfector are divided into four levels, as shown in the right column of buttons.

- Settings: Operator settings to be used in day-to-day operation.
- Language: To be chosen during initial installation and used in day-to-day operation.
- Configuration: Installer settings to be used during initial installation and service (password protected).
- Factory: Manufacturer settings (password protected).

5.2.4 Flowchart

The flowchart is a color-coordinated visualization of the process in the lower part of the cabinet. The flowchart supplies important information, such as water temperature, cell current, and brine pump flow (Figure 16).

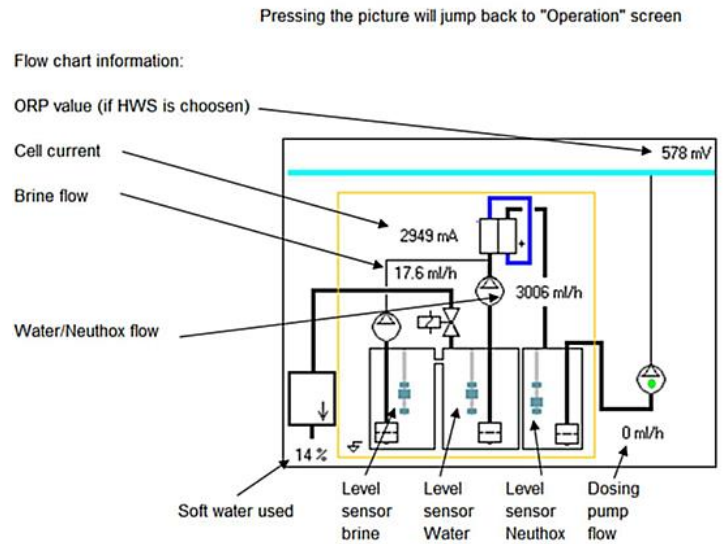

Figure 16 - Flowchart

The arrow on the pump symbol will point from 9 to 11 o'clock depending on whether it is regulating up or down. At horizontal position (9 o'clock) it is regulating steadily and above it is increasing the flow.

A green dot in the pump symbol shows every time a stroke signal is given. In case of an alarm a red dot is displayed at the sensor giving alarm.

The flowchart screen contains two shortcuts that navigates directly to operation screen:

- Cell
- Brine pump or cell current

5.2.5 Information

On the information screen the following information is available (Figure 17):

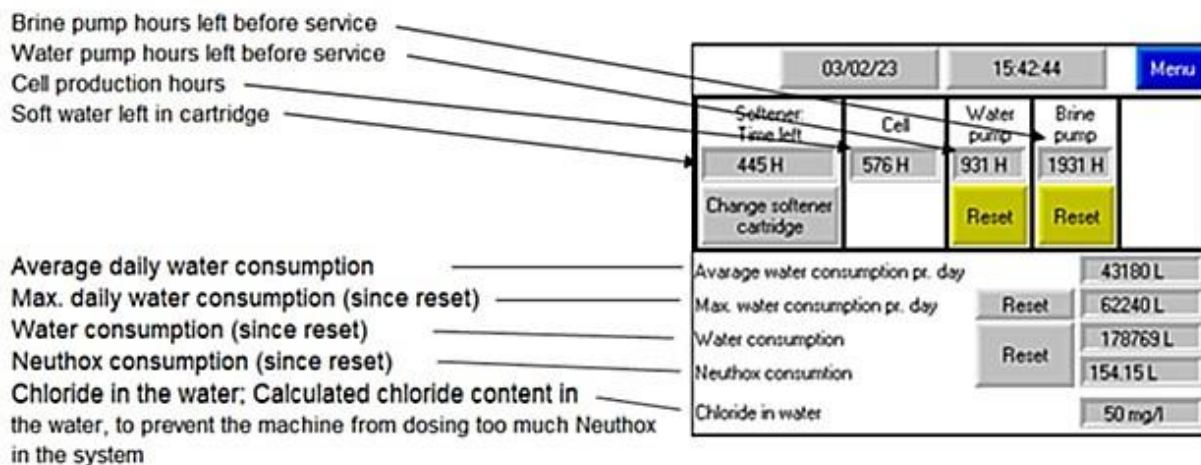

Figure 17 - Information screen

5.2.6 Trends

The trend contains data on cell power, brine flow and temperature from the last 24 hours. It is possible to toggle between 24- and one-hour display by pressing the Trend button. In the lower part of the display the current view is visible.

At one-hour view, the data is displayed in one-minute increments and in 24-hour view in 15 minutes increments. By pressing the display, it is possible to toggle between the different values.

5.2.7 Language

Choose the required local language by pressing the appropriate flag (Figure 18).



Figure 18 - Language selection

5.2.8 Settings

The settings menu contains settings and functions appropriate for operators during normal day-to-day handling. Some buttons are inactive in the BWT Desinfecton version of the software. The buttons below provide the following options (Figure 19):

- Neuthox/Cathox internal pH settings - Enabled.
- Communication: Only TCP/IP - Enabled.
- Data log - Disabled.
- Batch run - Disabled.



Figure 19 - Settings options

5.2.9 Communication

5.2.9.1 Communication Menu

The communication button will lead to the following two communication options illustrated in Figure 20.

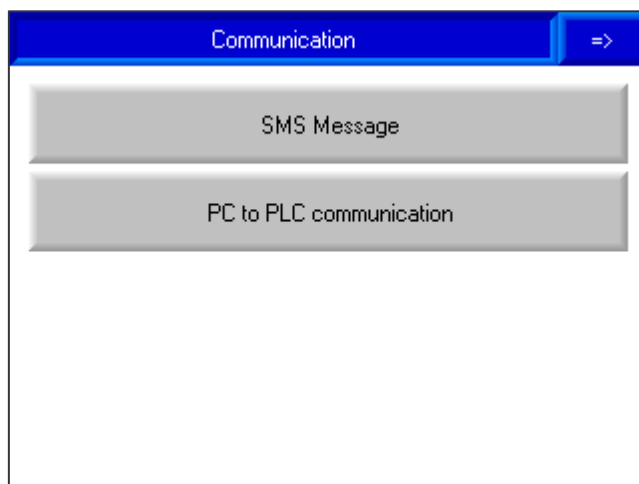

Figure 20 - Communication options

5.2.9.2 SMS Message

If the BWT Desinfector is equipped with a modem for mobile phone messages, then SMS communication is possible. Insert a SIM card into the modem.

To utilize the SMS function:

1. Insert SIM-card with known phone number into any available cell phone and change PIN code to "4323".
2. Turn off power for BWT Desinfector.
3. Insert SIM card into modem (Figure 21).



Figure 21 - Modem with SIM card

4. Power modem off and on again, to start initialization.
5. A blinking green LED indicates that modem is searching for network connection, wait (this can take several minutes) until a steady green LED indicates that modem has found network to connect to.
6. In SMS menu on the HMI controller an indication shows whether or not modem is initialized.
7. Press telephone number button to enter in number of telephone, which is to receive SMS in case of an alarm.

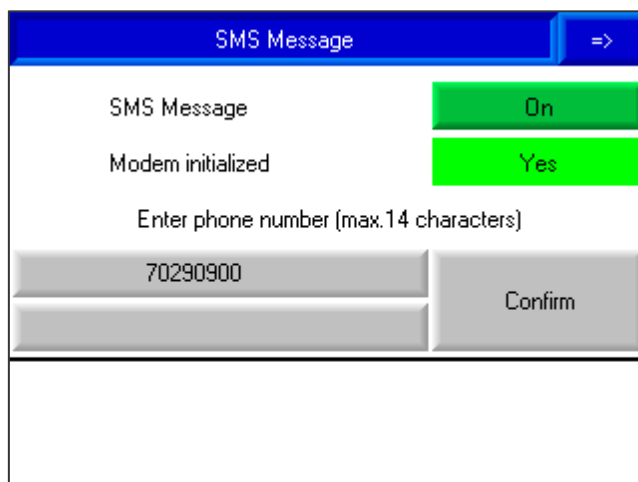

Figure 22 - SMS setup

5.2.9.3 PC to PLC Communication

It is possible to setup the BWT Desinfector for Modbus TCP/IP communication over Ethernet, hereby allowing supervisory control and data acquisition systems (SCADA) to start/stop the BWT Desinfector and receive alarm messages. BWT will only offer support on the HMI controller software, all other support concerning communication is to be handled by the sales partner.

If the BWT Desinfector is equipped with an Ethernet card, then communication via Modbus TCP/IP or Remote Access (Unitronics freeware) is possible. Connect to the BWT Desinfector via the RJ45 plug on the side of the PLC.

In the PC to PLC menu, it is possible to put in the Network ID (or slave ID) and setup the addressing for the slave with the Configuration slave button (Figure 23).

Master addressing =>	
IP adresse	192 168 1 2
Subnet address:	255 255 255 0
Gateway	192 168 1 1
Port number	502
PLC name	DCW
Confirm	

Figure 23 - PC to PLC Communication

The Modbus addresses to poll/write are available in section 10.

Always use a static IP address when setting up PC to PLC Communication.

5.2.10 Configuration

Installer technician: To enter the Configuration submenu a password is needed:

- Password for Configuration submenu: "4323".

Neuthox® Production (left column in Figure 24):

- Softener settings: Set time between regenerations, based on the water hardness.
- Installing new cell: Configure a new cell after replacement.
- Manual operation: Control the electrical components during troubleshooting.
- Service: Reset running hours after servicing pumps or ORP-sensor. Refer to the service manual for details on servicing the BWT Desinfector.
- Buffer tank: Configure the size of the attached Neuthox® buffer tank.

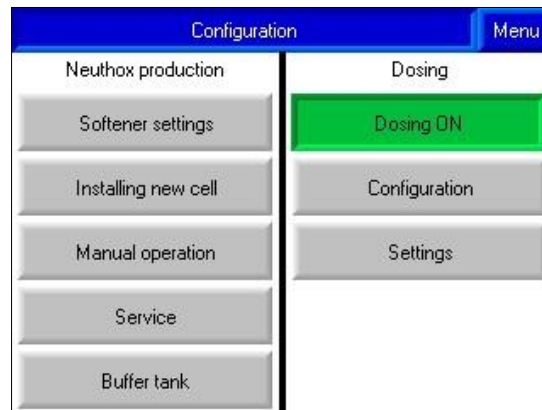

Figure 24 - Configuration menu

5.2.11 Dosing

The following dosing types are available on the BWT Desinfector:

- The ORP application with water meter is used for hot water systems in buildings (Figure 25). ORP application without water meter is used for any other setup where a specific ORP value should be targeted.

When setting the dosing system up for hot water systems, please provide the output from the water meter in liters pr. pulse, the maximum capacity of the dosing pump, and the actual setting of the dosing pump. The same information – except the water meter setting – is necessary for ORP dosing.

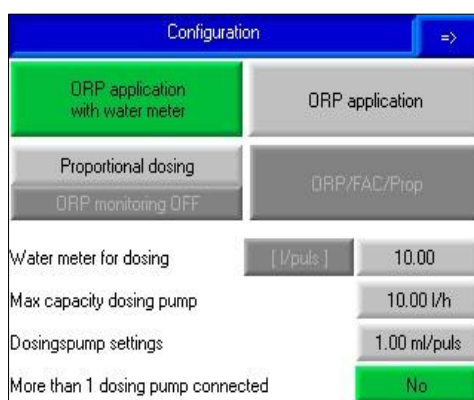

Figure 25 - Configuration screen for hot water system dosing

- Neuthox[®] dosing for proportional dosing is used in drinking water for human and livestock consumption. Dosing ppm is the amount of Neuthox[®] that will be dosed, for every pulse from the water meter. The Neuthox[®] will be dosed evenly between 2 pulses from the water meter (Figure 26).

When setting the dosing system up for proportional dosing, please provide the output from the water meter in liters pr. pulse. If desired, an ORP sensor may be connected. The measured ORP-value will be displayed on the Operation screen, but will not be used by the dosing regulator.

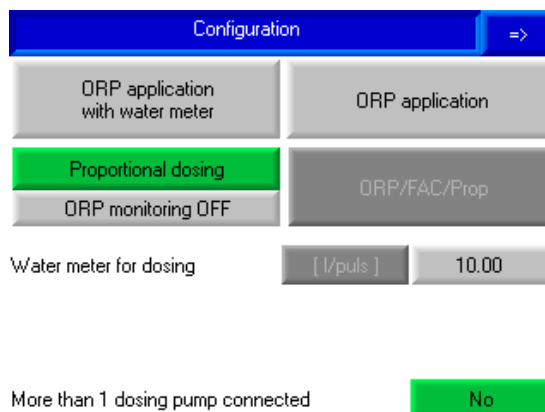

Figure 26 - Proportional dosing

5.2.12 Proportional Dosing

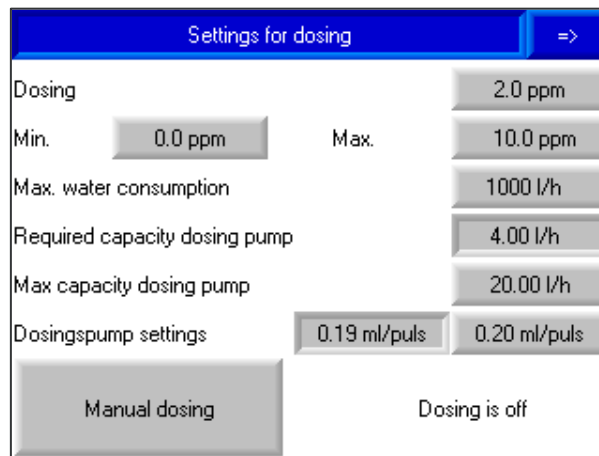

Figure 27 - Proportional dosing settings

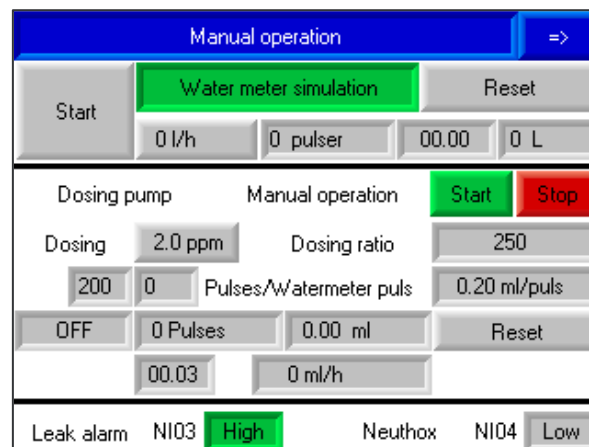

Figure 28 - Proportional dosing, manual operation

5.2.12.1 Settings

The required settings for the proportional dosing system are:

- Dosing: The desired concentration of Neuthox® in the water.
- Min. & Max.: The minimum and maximum acceptable concentrations of Neuthox® in the water. These are enforced when the end user sets the desired concentration on the operation display.
- Max. water consumption: The expected maximum water consumption in the system into which Neuthox® is injected.
- Required capacity dosing pump: Not user configurable. The minimum dosing pump capacity necessary to meet the configured dosing requirements.
- Max capacity dosing pump: The actual capacity of the installed dosing pump.
- Dosing pump settings: The first field displays the recommended setting of the dosing pump. Input the actual setting in the second field.

5.2.12.2 Manual Dosing

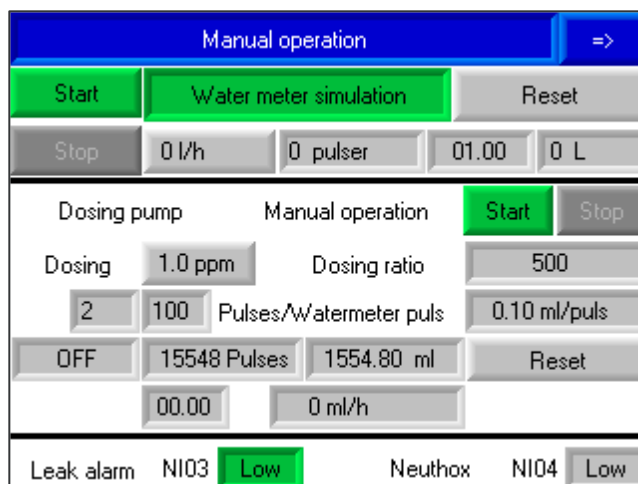

Figure 29 - Manual operation

The proportional dosing Manual operation screen allows running the dosing pump in accordance with a simulated water meter input.

After input of the desired simulated water flow and dosage and tapping the respective Start buttons, the dosing pump will be driven according to these values.

5.2.13 ORP Application

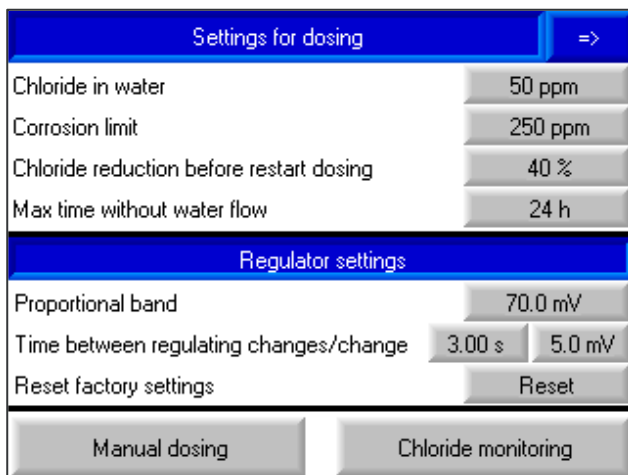

Figure 30 - Settings, ORP with water meter

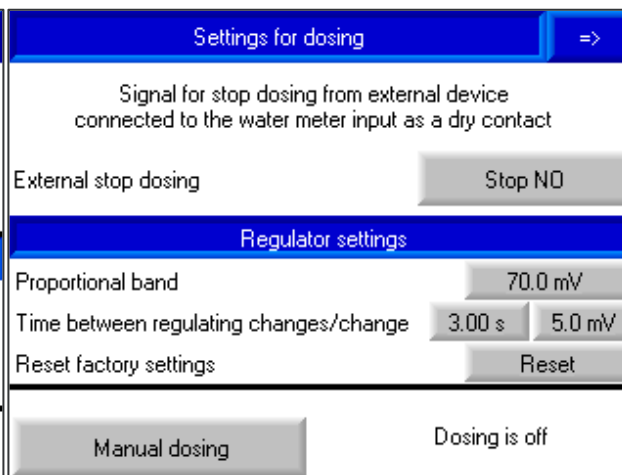

Figure 31 - Settings, ORP w/o water meter

5.2.13.1 Settings for Dosing, ORP with water meter

The following dosing settings are available for hot water systems:

- Chloride in water: Salt concentration in the supply. Can be retrieved from the local water supplier or measured with strip test, that can be supplied by BWT upon request.
- Corrosion limit: There is a defined upper limit to avoid chloride build-up in the system with thereof following corrosion. Therefor the dosing system stops if the chloride content rises above 250 PPM for the allowable hours.
- Chloride reduction before restart dosing: Dosing will restart, when chloride content has reduced to $40\% \times 250 \text{ ppm} = 100 \text{ ppm}$.
- Maximum time without water flow: Determines the amount of time that the BWT Desinfector should wait before stopping Neuthox® dosing, when the water meter has not been sending any signals.

5.2.13.2 Settings for Dosing, ORP without water meter

The only non-regulator setting available for ORP systems without an attached water meter is wither an external stop signal connected to the water meter input is NO or NC. If using an external stop switch, please configure this setting accordingly.

5.2.13.3 Regulator settings

These settings allow for adjusting the dosing regulator:

- Proportional band: Allowable deviation above SP before active regulator intervention.
- Time between regulating changes/change: Period and amplitude of active regulator intervention.
- Reset factory settings: Revert to the default settings from the factory.

5.2.13.4 Chloride Monitoring

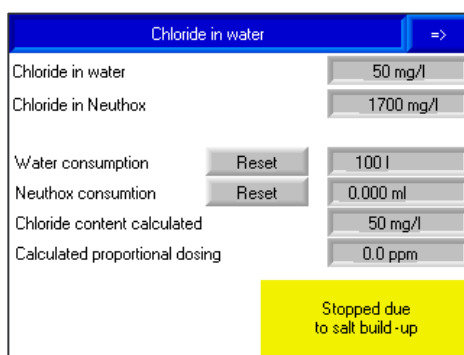

Figure 32 - Chloride monitoring

The chloride monitoring screen shows the calculated chloride content in the water after injection of Neuthox® as well as the resultant proportional dosage.

Tapping either "Reset"-button will zero the relevant counter.

5.2.13.5 Manual Dosing

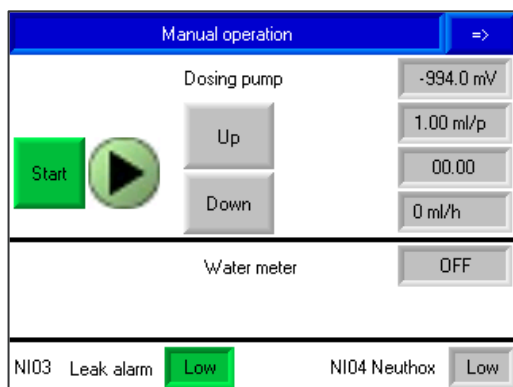

Figure 33 - Manual operation, water meter attached

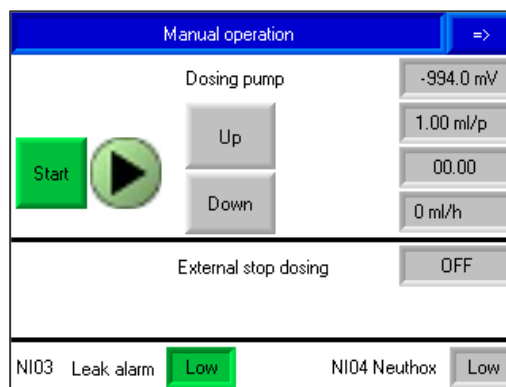

Figure 34 - Manual operation, no water meter

The ORP Manual operation screen provides direct control over the dosing pump while displaying the measured ORP-value and pump settings.

5.2.13.6 ORP Calibration

The calibration screen contains the following (Figure 35):

- Calibration fluid mean value: Insert the value from the calibration fluid.
- Measured voltage: The value measured by ORP sensor.
- Calibrate: When the sensor is placed in the calibration fluid. Press **Calibrate** and then the value of the sensor will be set to the same value as the calibration fluid.
- ORP process value: The value measured by the ORP sensor. **Load Default** will set the default value to 1.000 if the sensor has not been calibrated.

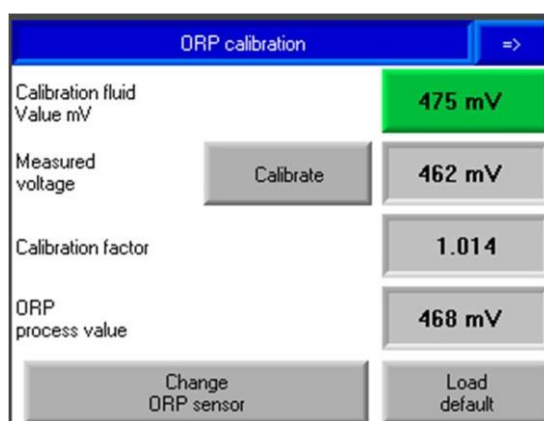

Figure 35 - Calibration screen

5.2.14 Softener settings

The Softener settings permits the selection of the installed water softener system (Figure 36).

The options are

- Softener cartridge: The main water supply passes through a cartridge type water softener system before entering the BWT Desinfector.
- Softener: An external water softener conditions the water before it enters the BWT Desinfector.
- RO water: The BWT Desinfector is supplied with water from a reverse osmosis water purification system. If this option is selected, no further configuration is possible.

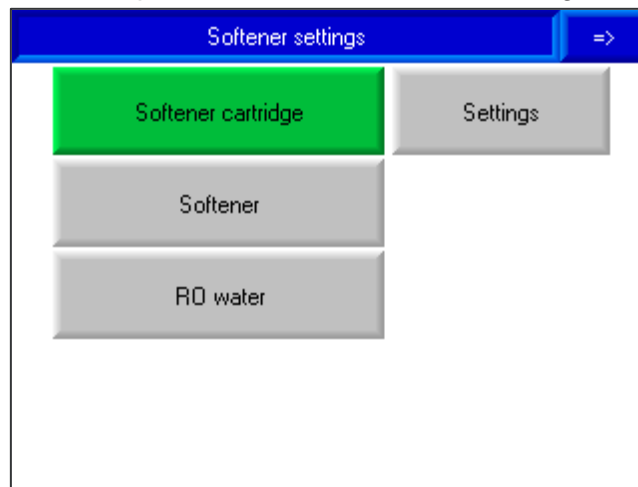

Figure 36 - Softener type selection screen



5.2.14.1 Softener Cartridge

Softener settings =>				
Water hardness	30 °dH		540 ppm	
Water consumption	10000 l/day			
	m3/ppm	L	Day(s)	Alarm set
BWT -S	100	1381	92	0 Day(s)
BWT -V	176	1381	162	0 Day(s)
BWT -XL	458	1381	424	0 Day(s)
BWT -2XL	746	1381	690	0 Day(s)

Figure 37 - Softener cartridge settings

Select the installed cartridge from the list and enter the supply water hardness. If you also enter the expected daily water consumption, the controller will calculate how long the cartridge may be expected to last. Once Neuthox® production is started, this value will be updated to reflect measured values.

If a value is entered in the field "Alarm set", a yellow alert will be generated after this many days before an upcoming cartridge change. A red alert will be generated, and production halted when the cartridge has reached the end of its service life. This alert is triggered by actual, measured use and depends on the chosen cartridge size.

	CAUTION	
<p>The selected cartridge must reflect the actually installed cartridge. Otherwise the production process may continue with a spent cartridge, causing damage to the electrolysis cell and other components.</p>		

5.2.14.2 Softener

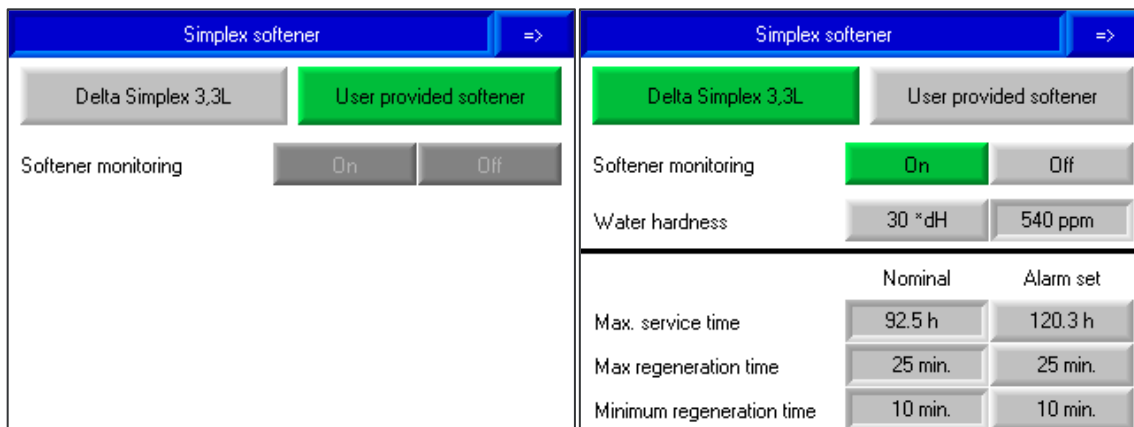

Figure 38 - User provided softener



Figure 39 - Delta Simplex

If "User provided softener" is selected (Figure 38), no further configuration is possible. It is assumed that any required maintenance, including periodic regeneration, is performed correctly such that the supplied water always meets the requirements of the BWT Desinfector.

If "Delta Simplex 3,3L" is selected (Figure 39) and Softener monitoring is enabled, the BWT Desinfector will alert the user if regeneration is not performed correctly. The only parameter that needs to be configured is water hardness.

5.2.14.3 RO water

Select this if the BWT Desinfector is supplied with water from a reverse osmosis system. Note that no monitoring of the water is performed. It is thus incumbent on the user to ensure water of a satisfactory purity.

	CAUTION	
<p>If the BWT Desinfector is not supplied water of sufficient purity, the electrolysis cell will be damaged. Such damage is not the responsibility of BWT Danmark.</p>		



5.2.15 Installing New Cell

Cell data =>			
Installing new cell			
Cell current	Actual	<input type="text" value="0.00 A"/>	Setpoint 0.00 A
Temperature	Actual	<input type="text" value="0.0 °C"/>	Data 0.0 °C
Brine pump	Actual	<input type="text" value="0.0 ml/h"/>	Data 0 ml/h
Factory	Actual	<input type="text" value="0 ml/h"/>	
Reset factory settings		Confirm running parameters	

Figure 40 - New cell installation

Use this screen to configure the BWT Desinfector following replacement of the electrolysis cell.

To set parameters, start production from the operation screen, then enter the Installing new cell screen. Once the cell current has been stable in the correct interval for a minute, the Confirm running parameters button becomes active and, when tapped, will cause the measured parameters to be stored for the regulator.

	CAUTION	
<p>This screen is only to be used by the service technician and only following replacement of the electrolysis. Any other use may cause degraded performance or malfunction of the BWT Desinfector. BWT Denmark accepts no responsibility for such consequences.</p>		

5.2.16 Manual Operation

Descriptions for manual operation of the BWT Desinfector can be found in section 6.5.1.1. Manual operation is to be performed exclusively by the installer and the service technicians.

5.2.17 Buffer tank

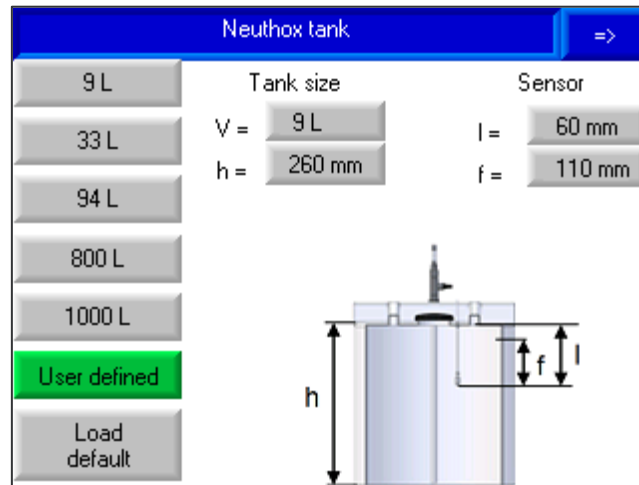

Figure 41 - Configuration of Neuthox® tank

If the Neuthox® buffer tank is replaced with one of a different type than originally supplied, the generator must be configured for the new tank. A choice of pre-defined tanks is available, or a user defined tank can be described.



If installing a user defined tank, these parameters need to be entered:

- V: Total volume of the tank *below the lid*.
- h: Total height of the tank *below the lid*.
- l: Distance from the level sensor to the top of the tank as shown on Figure 41.
- f: Distance from the level sensor to the highest level to which Neuthox® should be filled.

6 Handling, Installation, Connection, and Testing

This section contains the installation and start up procedures for BWT Desinfector. To ensure that the BWT Desinfector and its components are handled correctly and safely, follow the instructions in this section. If in doubt, then contact BWT for support. Never attempt to assemble or connect if there is any doubt as to how to do it, or if faults and defects are present in the BWT Desinfector and its associated equipment.

6.1 Handling and Lifting Instructions

	WARNING	
Mounting the BWT Desinfector is a job for two persons. Do not try to mount it alone.		

6.2 Storage Before Installation

The BWT Desinfector shall be stored in a safe, frost-free, and dry place prior to installation and must be handled with care. Furthermore, the BWT Desinfector may not be placed in a horizontal position in case there is water in the internal tank(s). The BWT Desinfector should stay in a vertical position within its original packaging until it is to be installed.

6.3 Installation

The BWT Desinfector should be installed in a frost-free and well-ventilated room.

The BWT Desinfector should be mounted on an appropriate wall, which can carry the full load of the BWT Desinfector according to the technical specifications.

It is recommended to mount the BWT Desinfector with 6-8 mm screws, with hexagon heads. The backside of the cabinet is mounted onto two brackets, one in each top-corner. If there is no available wall space for the BWT Desinfector, then refer to section 6.3.3 for instructions on attachment to mounting rack (Figure 42).

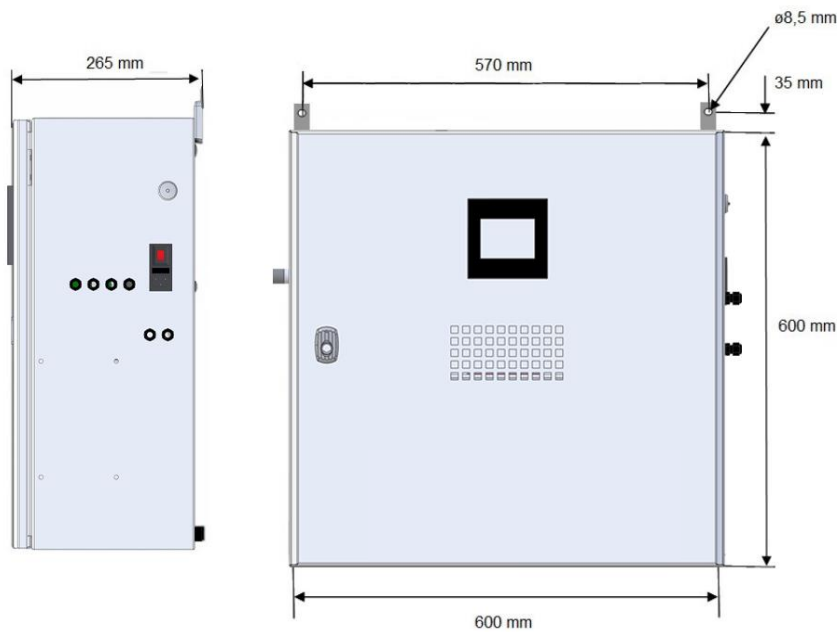





Figure 42 - Installation specifications

6.3.1 Installation Safety Instructions

	CAUTION	
<ul style="list-style-type: none">• The BWT Desinfector is vulnerable to the surrounding atmosphere.• Do not install the BWT Desinfector anywhere that may be considered as a corrosive environment.		

	WARNING	
<p>The BWT Desinfector is not approved for operations in potentially explosive atmospheres.</p>		

6.3.2 Installation Procedure

	NOTICE	
<ul style="list-style-type: none">• Mount the BWT Desinfector in such a way, that it allows the operator easy access, during both operation of the HMI controller and maintenance inside the cabinet.• The BWT Desinfector should be mounted so the PLC is within eye level of operator and should always be mounted above the external tanks.• There must be enough space between the BWT Desinfector and external tanks to ensure straight connections. There should not be any bending of or water locks on the hoses.		

1. Measure out the installation height for the BWT Desinfector, BWT recommends an installation height within 1600 to 1800 mm from the floor.
2. Verify that BWT Desinfector will be mounted with PLC within eye level of operator and above external tanks with enough space to ensure straight connections.
3. Drill holes into wall for brackets (Ø8 mm) with 570 mm between them.
4. Install brackets (Ø8 mm) onto BWT Desinfector into corresponding bracket holes at the back of the cabinet.
5. Mount BWT Desinfector onto wall.

6.3.3 Attachment to Mounting Rack

	WARNING	
<p>The rack must be secured to the floor, due to the construction being heavies at the top and therefor can topple over.</p>		

If there is no clear wall-space at the installation site, then a mounting rack can be constructed for the BWT Desinfector. Specifications for an acceptable mounting rack is provided in Figure 43. All measurements are provided in millimeters.

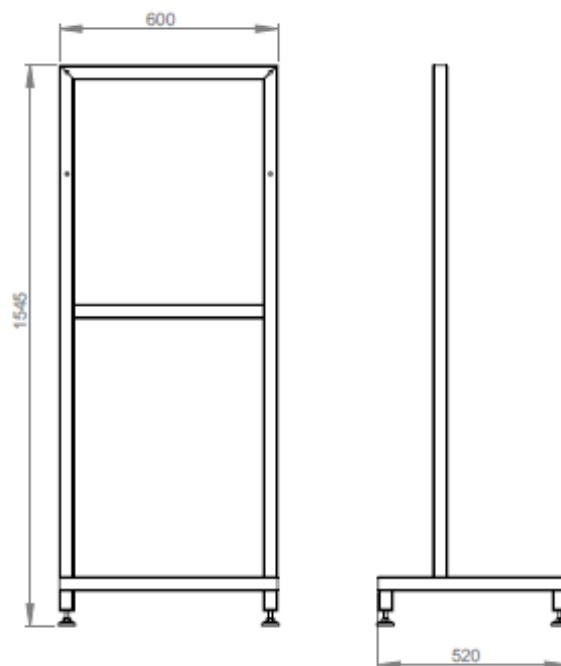

Figure 43 - Specifications for mounting rack

6.3.4 Peristaltic Pumps

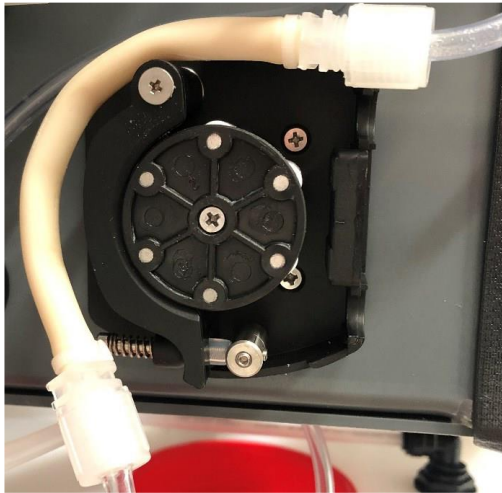

Figure 44 - Water pump as delivered from factory



Figure 45 - Pump cover

When the BWT Desinfecton is delivered from the factory, the water pump will have its cover removed and the internal hose detached. Before connecting the generator to water or electrical supply, the hose and the included pump cover must be reinstalled.

The pump cover and the necessary screws are included in an accessory bag.

To install the hose, open the latch and reattach the hose as shown on Figure 46. Then mount the cover and install the two included screws. Do not use any force when mounting the cover.

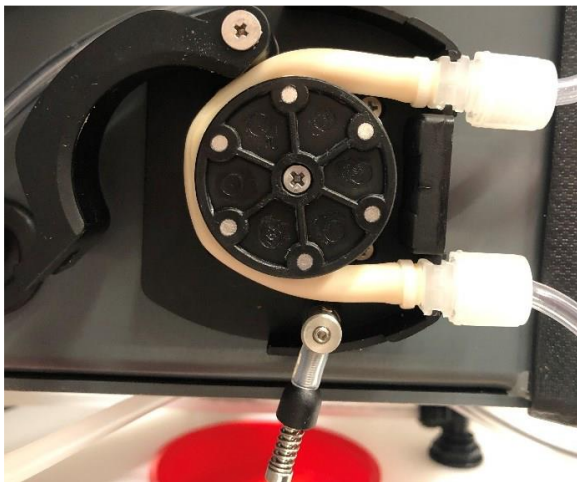

Figure 46 - Pump with hose reinstalled



Figure 47 - Completed pump

6.4 Connection to Supply Sources

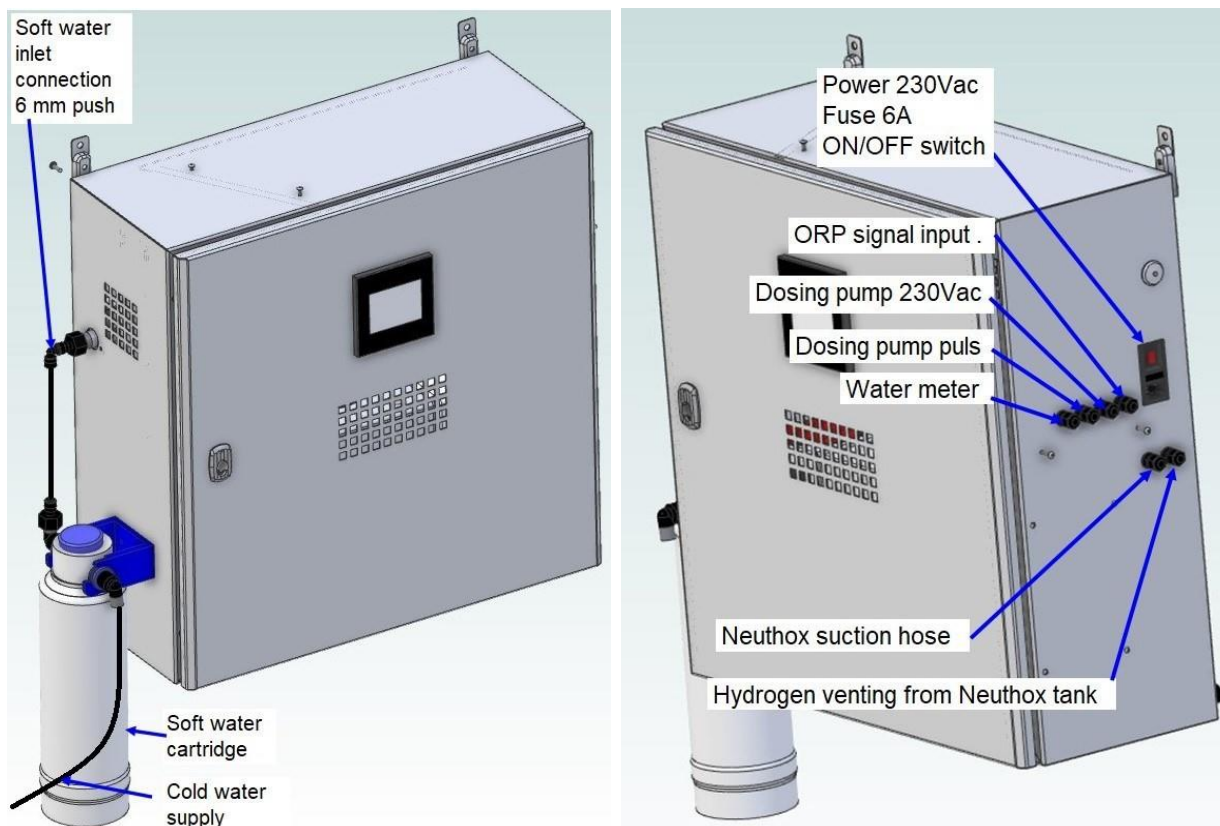



Figure 48 - Connection points for supply sources

6.4.1 Safety When Connecting

	WARNING	
<p>When producing Neuthox® at low pH, the BWT Desinfector forms chlorine gas. A ventilation pipe must be installed from the buffer tank and the buffer tank must not be sealed. BWT support will be able to advise on this.</p> <ul style="list-style-type: none"> • There is a non-zero, yet highly unlikely, risk that a defective unit may produce small amounts of chlorine gas. For this reason, ventilation requirements as stated in section 4.3 must be adhered to. • In spaces with insufficient ventilation, the gas must be discharged through a hose to an outside area. 		



WARNING



- If the BWT Desinfector is located in a small, confined space without adequate ventilation, it is necessary to fit an exhaust/ventilation system onto the cabinet, which BWT service support will be able to advise on.
- In spaces with insufficient ventilation, the gas must be discharged through a hose to an outside area.
- Ventilation requirements can be found in the specifications in section 4.3.

6.4.2 Water Supply Connection



NOTICE



- The water pressure should be minimum 2 bar.
- When adjusting the length of the supply hoses, the hose must be cut with a sharp blade to ensure that it stays round. Do not use a tool that squeezes the hose, when cutting.



CAUTION



- The water quality must fulfill the drinking water specifications 98/83/EC and softened to less than 5 ppm hardness. If this is not adhered to, then the softener and cell can be damaged due to lime scale build-up.
- A water softener must be connected to the BWT Desinfector. This can be purchased at BWT or by another manufacturer.
- If the water softener is not equipped with an ion-exchanger, then the user must ensure to supply one to the system.
- The content of FAC in the supply water for the BWT Desinfector must never exceed 0,2 ppm, as this will damage the softener.
- FAC chock dosing in supply water at max. 2 ppm, should not be done more than twice a year.

The BWT Desinfector must be supplied with soft water to avoid lime scale in the cell. A water softener must be connected to the BWT Desinfector. This can be purchased at BWT or by another manufacturer.

The water supply for the BWT Desinfector requires as a minimum installation of a Medium Category 2 non-return valve with sampling:

- Controllable non-return valve (Type EA according to DS/EN-1717)

The BWT Desinfector has one female 6 mm push-in connection for water inlet. The water supply must be from a water softener with less than 5 ppm hardness, containing less than 0.5 mg/l of iron and less than 0.1 mg/l of manganese. The supply pressure must be within the limits stated in section 4.3 (Figure 49).



Figure 49 - Connection point for water supply

The soft water tank is placed inside the cabinet on the BWT Desinfector. The tank is connected to the brine tank. The level sensor in the tank is connected to the plug NI01 on the PCB and the leak sensor is connected to the plug NI03 on the PCB. Refer to Figure 5 for visual illustration.

6.4.3 Electrical Supply Connection

	WARNING	
The supply voltage must correspond with the values specified for the BWT Desinfector.		

The BWT Desinfector is supplied with 230 VAC ($\pm 10\%$); 50 Hz via a C14-IEC connector, for easy connection to the power supply (Figure 50).

Connect the BWT Desinfector to the electrical power supply and ensure the BWT Desinfector is connected to a grounded outlet.

Figure 50 - Connection points

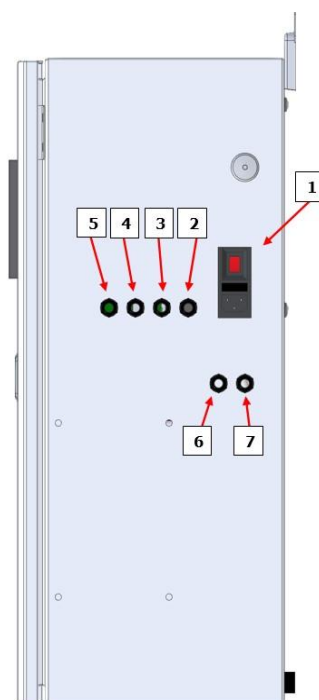

1	Power 230 Vac Fuse 6A ON/OFF switch
2	Access point for ORP signal input
3	Access point for dosing pump 230 Vac power supply
4	Access point for dosing pump pulse
5	Access point for water meter
6	Valve for Neuthox [®] suction hose
7	Hydrogen venting valve from Neuthox [®] tank

6.4.4 Neuthox® Tank Connection

	WARNING	
<p>Neuthox® and residual chloride can become corrosive at high concentrations. Beware of material specifications.</p>		

In spaces with insufficient ventilation, the gas venting hose should be fitted with a hose outlet, which discharges the gases to an outdoor area.

For the Neuthox® tank connections, only use the following materials:

- Polyethylene (PE)
- Polyvinylidene fluoride (PVDF)
- Polyvinylchloride (PVC)
- Polytetrafluorethylene (PTFE)
- Viton (FKM/FPM)

Do not use any type of metal when connecting to the Neuthox® tank (Figure 51).



Figure 51 - Neuthox® tank connection requirements

6.4.5 Dosing Pump Installation on BWT Desinfector

The BWT Desinfector has no internal dosing pump, but an external dosing pump can be mounted on the right side of the cabinet.

The BWT Desinfector can supply power for an external dosing pump, by connecting it directly to the terminals inside the cabinet (Figure 52). Refer to Electrical Circuit Diagram in section 11.1 for further information on connections.

The pump can be governed by the HMI controller, based on an ORP-measurement and/or the pulses from the water meter.

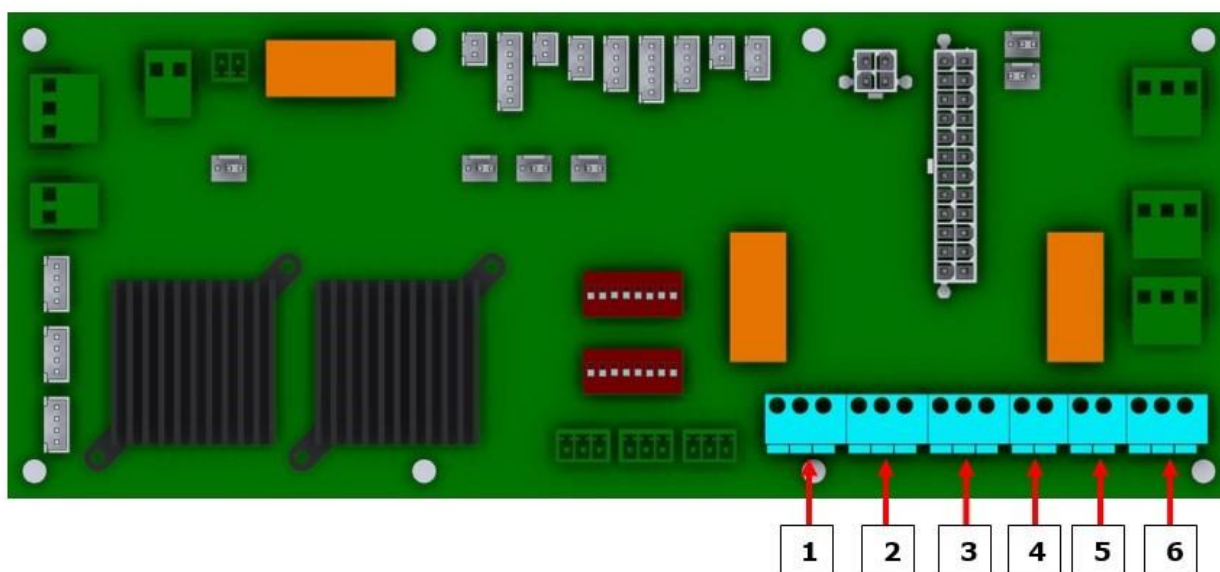

Figure 52 - Terminals for external connections

Alarm	
1	Dry contact NO or NC for alarm
Dosing	
2	4-20 mA from ORP transmitter
3	Pulses from water meter. Use V+ and P for reed contact.
4	Pulses for dosing pump
5	For future use.
6	230 Vac power supply for dosing pump

A suction filter is already installed in the Neuthox[®] tank, with a 1,5 m 6/4 mm PVC hose. Install the pump and injector according to the instructions from the dosing pump supplier.

Connect the dosing pump and water meter: Set the dosing pump for pulse control, and set the same ml/pulse on the pump, as in the PLC.

6.4.5.1 Water Meter Connection

To prevent overdosing during times with low water consumption, pulses from a water meter is collected in the HMI controller and dosing stopped if water consumptions drop below specified values entered in the HMI controller.



The 2 or 3-lead cable from the water meter is connected directly to the terminals inside the cabinet. If the water meter uses a transistor output be aware of polarity (Figure 52).

The water meter is connected to the relay coil and 24 VDC from the BWT Desinfector.

The BWT Desinfector is connected to a relay contact.

Other CTS units are connected to one of the remaining relay contacts.

6.4.5.2 Splitter Box

	NOTICE	
<ul style="list-style-type: none">• If the pulse signal from the water meter in the supply for the hot water system already has been used for other equipment, then BWT can provide a splitter box which allows sharing of the signal, up to 4 receivers can be added. If the splitter box is not used, then only one receiver will be able to use the signal, in most cases this is the receiver with the highest potential.• Be aware that water meters with transistor output have specified polarity.		

The splitter box can be purchased as an extra accessory and is supplied with an electrical circuit diagram.

6.4.6 ORP Hot Water Supply Hardware Installation

Install dosing pump and water meter for hot water supply in accordance with section 6.4.5 and below illustrations in Figure 53 and Figure 54.

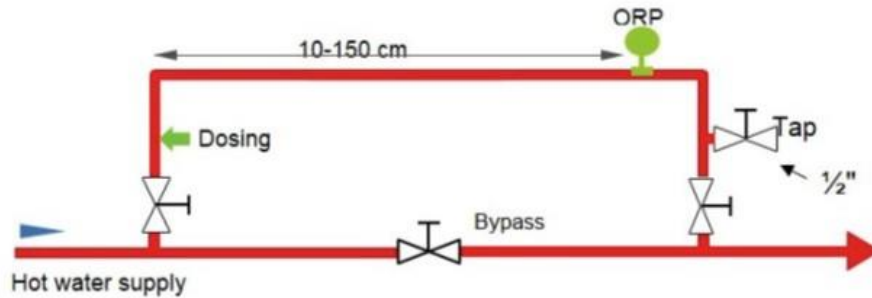

Figure 53 - Hot water supply hardware installation (1)

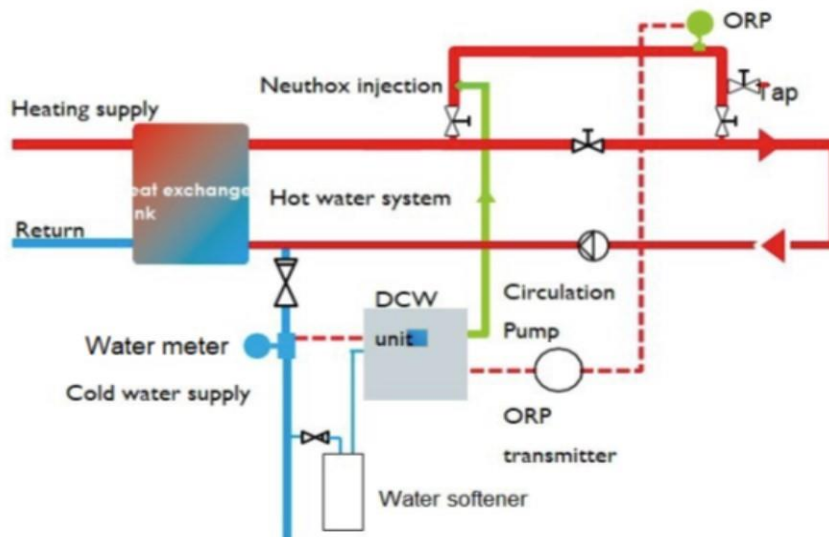

Figure 54 - Hot water supply hardware installation (2)

6.4.6.1 Injection Valve

The injection valve must be placed in such way that the Neuthox® is injected in the center of the stream. The valve has a 1/2" pipe thread for installation and can be placed in any orientation. Furthermore, there must be a non-return valve on the dosing spear (Figure 55).

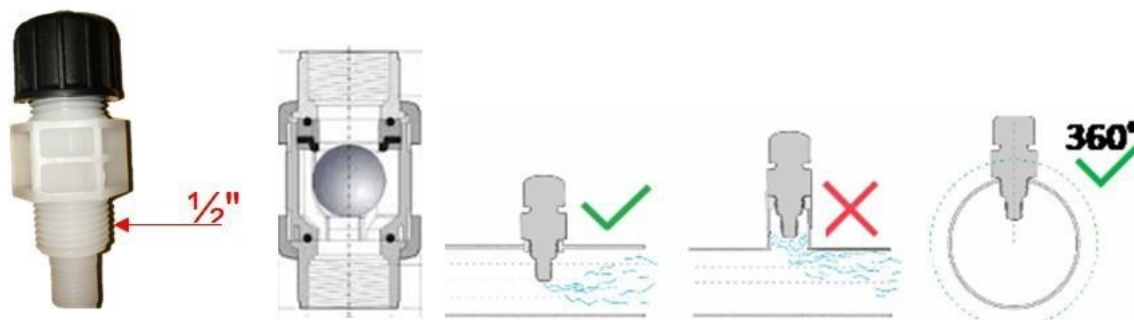

Figure 55 - Injection valve installation

6.4.6.2 ORP Sensor

The ORP-sensor must be calibrated by start-up, and the calibration can be done in the BWT. When the ORP-sensor is calibrated, then it can be installed in the water pipe.

The ORP-sensor must be installed vertically or at most 45° from vertical with the ORP sensor wire facing upward (Figure 56).

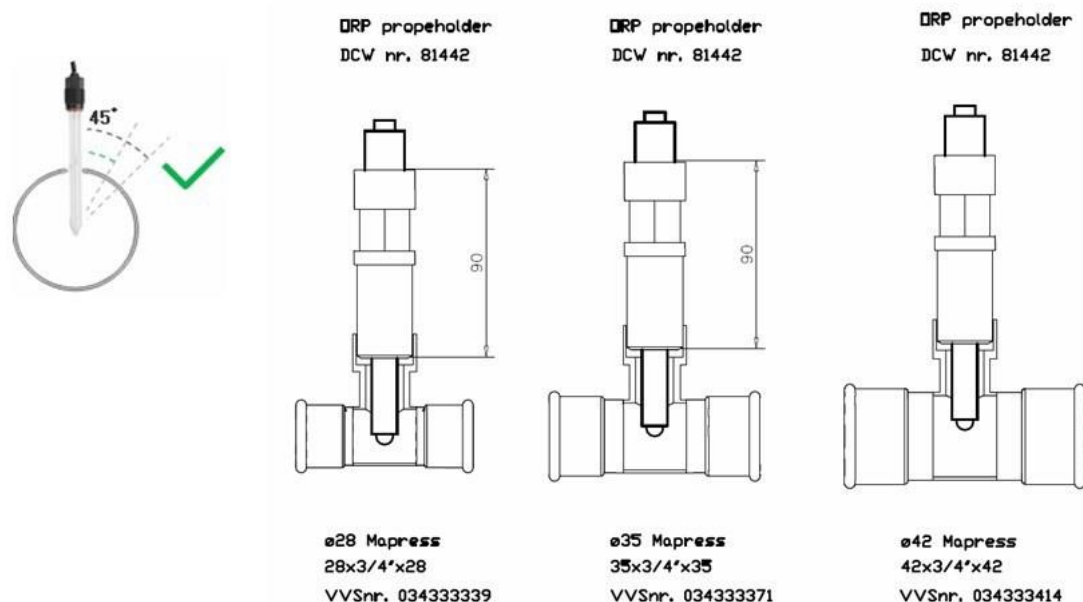

Figure 56 - ORP sensor installation

The ORP-sensor end should be in the center of the pipe. Must be installed after dosing connector in the flow direction. The ORP-sensor holder has a 3/4 thread and the ORP sensor has a PG13 thread in the sensor holder with an O-ring sealing (Figure 57).

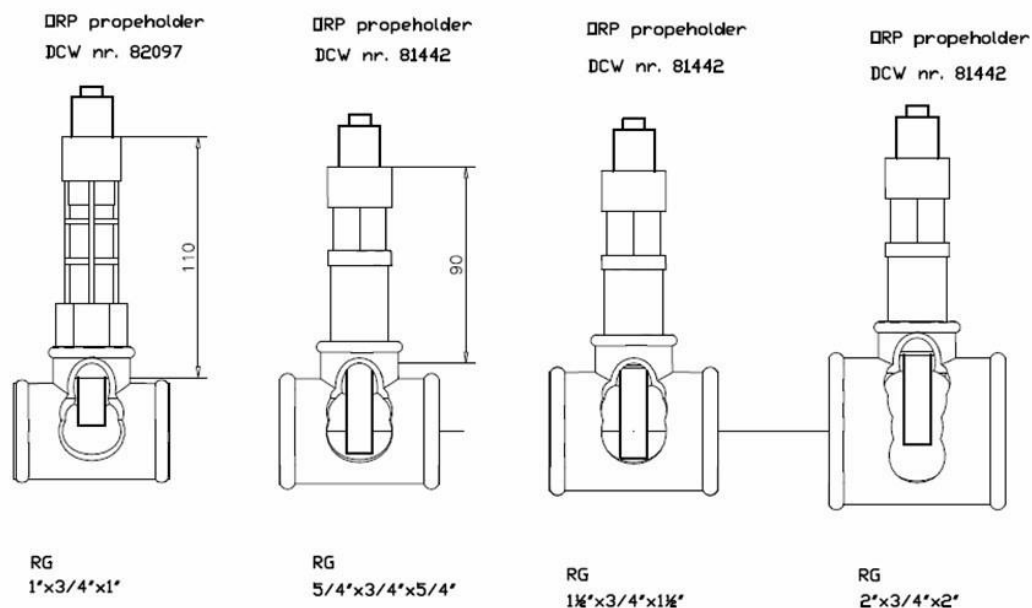

Figure 57 - ORP sensor

The ORP-sensor must be looped into the system to make sure that it can be taken out biannually for calibration, without shutting down the hot water supply.

6.4.6.3 ORP-transmitter

The process ORP-value is supplied to the BWT Desinfector as an analogue 4-20 mA signal, from the supplied transmitter. The cable from the transmitter is connected directly to the terminals inside the cabinet.

The ORP-transmitter and sensor are sensitive to EMI. To ensure proper function, they must not be installed near any other power source. A precise, required distance cannot be stated, as this depends on the emissions of nearby devices. Refer to Figure 52 for visual illustration and to Electrical Circuit Diagram in section 11.1 for further information on connections.

6.4.7 Proportional Dosing Hardware Installation

Install dosing pump and water meter for hot water supply in accordance with section 6.4.5 and in correspondence with below illustration in Figure 58.

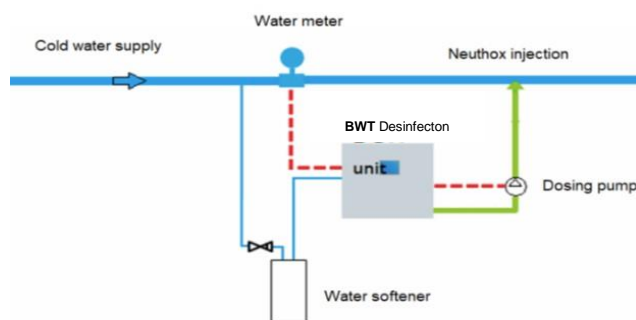

Figure 58 - Proportional dosing hardware installation

6.5 Commissioning by Installer

The commissioning sequence is only to be performed by the installer, who is commissioning the BWT Desinfector.

The sequence in section 6.5.1.1 is a guide for the installer on how to navigate the different sections in the HMI controller system for manual operation.

6.5.1 Manual Operation

Manual operation can be initiated by accessing Configuration menu with password: "4323", and the clicking on Manual operation (Figure 59).

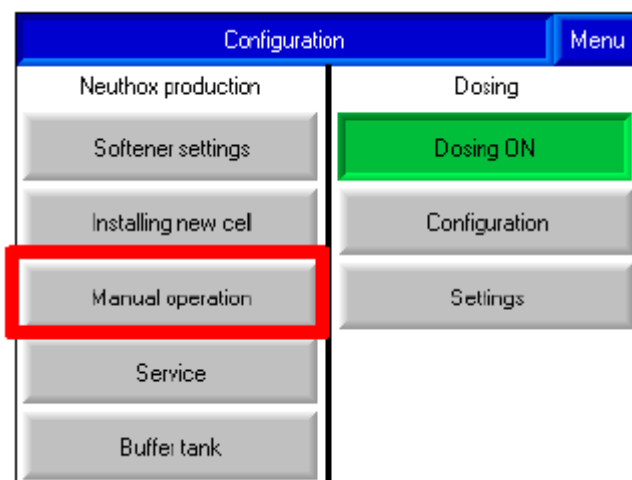

Figure 59 - Manual operation

The main water intake valve may be opened or closed using the button (Figure 60).

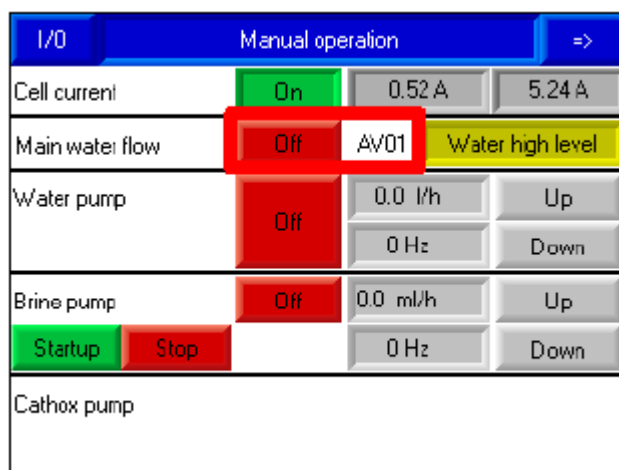

Figure 60 - Setting for AV01 filling valve

Press the corresponding Up or Down button to set the frequency for either process (water pump) or brine pump (Figure 61).

I/O	Manual operation			=>
Cell current	On	0.52 A	5.24 A	
Main water flow	Off	AV01	Water high level	
Water pump	Off	0.0 l/h	Up	
		0 Hz	Down	
Brine pump	Off	0.0 ml/h	Up	
		0 Hz	Down	
Startup		Stop		
Cathox pump				

Figure 61 - Up and Down buttons

Switch cell current by clicking either ON or OFF (Figure 62). The current readouts show the instantaneous current (on the right) and the current averaged over the previous 30 seconds (on the left).

I/O	Manual operation			=>
Cell current	On	0.52 A	5.24 A	
Main water flow	Off	AV01	Water high level	
Water pump	Off	0.0 l/h	Up	
		0 Hz	Down	
Brine pump	Off	0.0 ml/h	Up	
		0 Hz	Down	
Startup		Stop		
Cathox pump				

Figure 62 - Setting for cell current

If it is needed to check the state of the inputs, then click on I/O button (Figure 63).

I/O	Manual operation			=>
Cell current	On	0.52 A	5.24 A	
Main water flow	Off	AV01	Water high level	
Water pump	Off	0.0 l/h	Up	
		0 Hz	Down	
Brine pump	Off	0.0 ml/h	Up	
		0 Hz	Down	
Startup		Stop		
Cathox pump				

Figure 63 - I/O button

Ensure Input/Output values are as required (Figure 64).

- NI0x: Level sensors
- TM03: Temperature sensor
- VM01: Water meter pulse

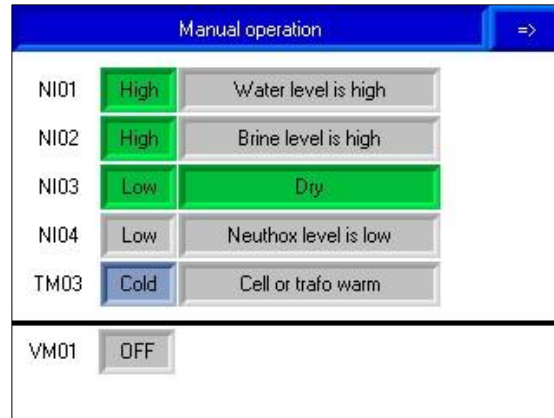

Figure 64 - Inputs

6.5.2 Safety at Commissioning

	CAUTION	
<ul style="list-style-type: none">• Care must be taken when performing commissioning.• Always disconnect water and power supply before working inside the BWT Desinfector.		

6.5.3 Commissioning Procedure

6.5.3.1 Softener Settings



The water softener or softener cartridge should be flushed before start-up of the BWT Desinfector.

For flushing, see the water softening system.

Configuration of the water softening system is explained in section 5.2.14 of this manual.

Prior to start-up, the local water hardness must be measured and entered into the HMI controller. The local water hardness can be measured with the hardness measuring kit supplied with the BWT Desinfector.

To account for communal water supply from various drillings, we recommend that 100 ppm are added to the measurement.

	CAUTION	
<p>Enter the local water hardness (+100 ppm) into the HMI controller to avoid lime scale in the cell.</p>		

6.5.3.2 Salt Filling

BWT recommends using food grade salt specified according to one of following standards, which both are suitable for electrolyzes and softener regeneration:

- EN 14805. Chemicals used for treatment of water intended for human consumption. Sodium chloride for on-site electro chlorination using non-membrane technology.
- EN 973. Chemicals used for treatment of water intended for human consumption. Sodium chloride for regeneration of ion exchangers.

1. Turn on water (Figure 65).

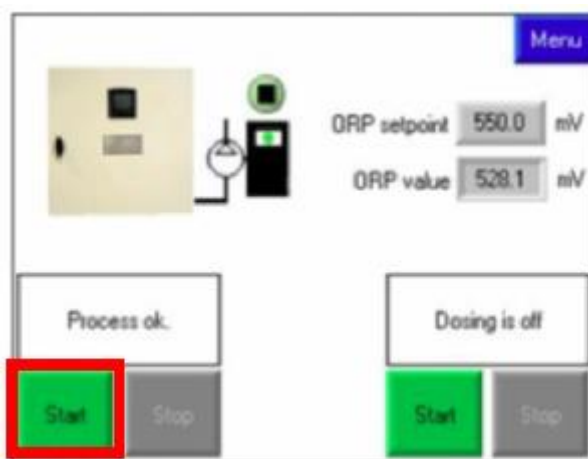

Figure 65 - Start button for water supply

2. While the tank is filling with water, wait for the water inlet to stop.
3. Add 5-8 kg salt into the water filled brine tank (Figure 66).

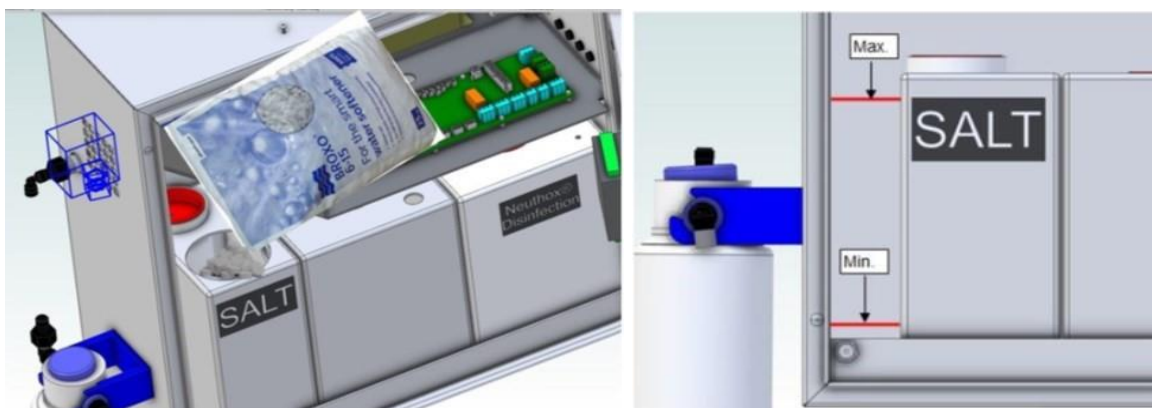

Figure 66 - Filling salt in brine tank

4. Ensure the following:
 - The level of salt is above water level.
 - No water is visible.
5. Wait while the salt soaks into the water and becomes a brine solution.

6.5.3.3 Brine Pump Priming

1. Tap Menu and then Configuration.
2. Enter the following password: 4323.
3. Tap Manual operation.
4. Tap the Startup button for Brine pump (Figure 67).

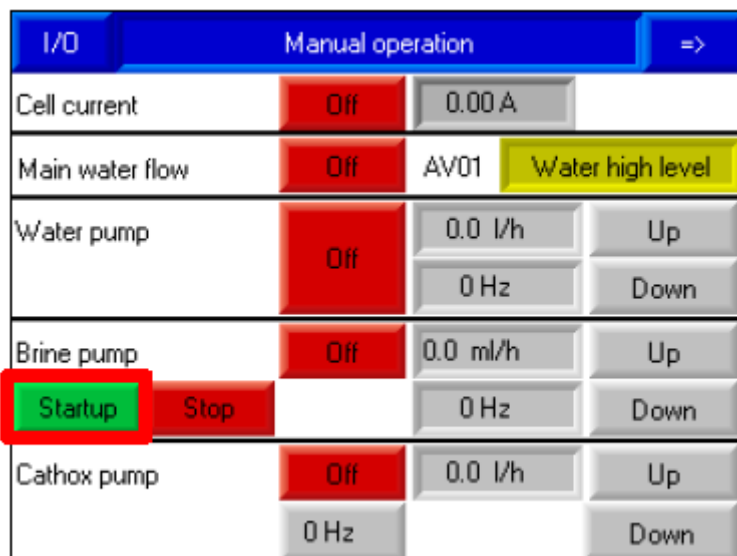

Figure 67 - Startup button for Brine pump

5. Wait for brine to reach the brine pump
6. Tap the Stop button

6.5.3.4 Neuthox® Dosing for Hot Water Systems

1. The Neuthox® dosing is started on the screen for Neuthox® dosing.
2. The setpoint for the ORP-sensor is set at 550 mV for first time start up.
3. The speed of the dosing pump is controlled to adjust the amount of Neuthox® dosed into the water.
4. The process level point is measured by the ORP-sensor.
5. The water meter informs the BWT Desinfecton of the water consumption in the system and ensures that the amount of Neuthox® dosed into the system, compared to the water consumption, will not exceed the accepted limit.
6. When the BWT Desinfecton has been running for some time, the amount of free chlorine in the system is measured with a water testing instrument.
7. Setpoint is adjusted to the permitted level according to the local legislation.
 - See process defined in Figure 68.

Hot water system is chosen

See text below

High value will slow down the regulating

Longer time will slow down the regulating
Higher mV change will increase the regulating speed

Water and Neuthox consumption.
Reset will reset the chloride calculation

$$\frac{((\text{Water} \times \text{Cl}_w) + (\text{Nx} \times \text{Cl}_{\text{Nx}}))}{(\text{Water} + \text{Nx})} =$$

$$\frac{((42390 \times 50) + (52,048 \times 1700))}{(42390 + 52,048)} = 52$$

$$\frac{\text{Neuthox FAC}}{(\text{Water} / \text{Nx})} =$$

$$\frac{500}{(42390 / 52,048)} = 0,6$$

Settings for dosing

Chloride in water	50 ppm
Corrosion limit	250 ppm
Chloride reduction before restart dosing	40 %
Max time without water flow	24 h

Regulator settings

Proportional band	70.0 mV
Time between regulating changes/change	3.00 s 5.0 mV
Reset factory settings	Reset

Manual dosing Chloride monitoring

Chloride in water

Chloride in water	50 mg/l
Chloride in Neuthox	1700 mg/l
Water consumption	Reset 42390 l
Neuthox consumption	Reset 52,048 l
Chloride content calculated	52 mg/l
Calculated proportional dosing	0.6 ppm

Dosing is on

Figure 68 - Neuthox® Dosing for Hot Water Systems

6.5.3.5 Neuthox® Dosing for Proportional Dosing

1. Start the Neuthox® dosing on the screen for Neuthox®.
2. The setpoint for the mixing ratio of Neuthox® in the water is set at 0,5-8 ppm or the permitted level according to the local legislation. Number of pulses from the water meter determines the speed of the dosing pump, the water meter informs the BWT Desinfector of the water consumption in the system and ensures that the amount of Neuthox® dosed into the system will not exceed the accepted limit.
3. When the BWT Desinfector has been running for some time, the amount of free chlorine in the system is measured with a water testing instrument.
4. Setpoint is adjusted to the permitted level according to the local legislation.

7 Safety



The safety instructions given in this manual and any existing national legislation on health protection must be adhered to at all times.



It is important to make reservations for visitors and other people who are not used to moving about in the area around the BWT Desinfector and are therefore not aware of the general safety measures or the signage of the BWT Desinfector.

- Before use, read the manual and complete any necessary training.
- Only a qualified Installer who has read the Operating Instructions thoroughly may install and commission the BWT Desinfector.
- Only trained operators who have read the Operating Instructions thoroughly are allowed to start and operate the BWT Desinfector.
- Consumables may only be refilled by trained operators who have read the Operating Instructions thoroughly.

7.1 Residual Risks

There may be hazards that have not been shielded against for practical reasons or for the sake of the BWT Desinfecton operation. These residual hazards are described in this section.

	CAUTION	
<ul style="list-style-type: none">• The water quality must fulfil drinking water specifications according to EN973. If this is not adhered to, then the softener and cell can be damaged.• The content of FAC in the supply water for the BWT Desinfecton must never exceed 0,2 ppm, as this will damage the softener. FAC chock dosing in supply water at max. 2 ppm, should not be done more than twice a year.		

	WARNING	
<p>The BWT Desinfecton forms small amounts of hydrogen as a byproduct. Room ventilation guideline must be followed.</p>		

	WARNING	
<p>Never use open fire or glowing sparks that may cause fires, near the BWT Desinfecton.</p>		

	WARNING	
<p>Neuthox® and residual chloride can become corrosive at high concentrations. Beware of material specifications.</p>		

8 BWT Desinfecton Operation

8.1 Information During Operation

Communication can be connected to the BWT Desinfecton, refer to section 0 for further information.

8.1.1 Visual Information/Warnings

The BWT Desinfecton is optionally equipped with a light beacon on top of the cabinet. Once the start button is pressed, a green light is emitted and will stay lit when the process is running and when it is stopped.

If a red or yellow alert occurs, the beacon will light in the corresponding color. The display will show detailed information about the cause of the alert.

8.2 Normal Operation

Once the BWT Desinfecton is installed according to the installation instructions in section 5.2.14.3, then it is possible to initiate start-up.

8.2.1 Switching on Electric Supply

The BWT Desinfecton is activated by connecting the machine to the mains power supply.

8.2.2 Neuthox[®] Production Process

Start the Neuthox[®] production on the operation screen, when the Neuthox[®] level is activating the level sensor in the tank, the will start a timer and fill additional 3 Liter Neuthox[®] in the tank.

The Neuthox[®] concentration is held constant by adjusting the brine pump speed. The faster the pump runs the higher the current will become. Neuthox[®] is produced inside the cell and runs into the Neuthox[®] tank.

8.3 Consumables

8.3.1 Salt

The electrolysis process requires salt. If there is no salt left in the brine tank, the BWT Desinfecton will set off an alarm.

To ensure a uniform production of Neuthox[®] and to avoid setting off the alarm, salt must be refilled at regular intervals. The time between refilling depends on the BWT Desinfecton size and Neuthox[®] consumption.

Refill salt in the brine tank according to section 6.5.3.2.

8.3.2 Water Softener Cartridge

The soft water cartridge must be serviced and replaced in accordance with manual for soft water cartridge. To reset the softener cartridge service interval, access the Information screen and tap the button "Change softener cartridge". On the screen that appears, tap "Reset", then "Confirm".

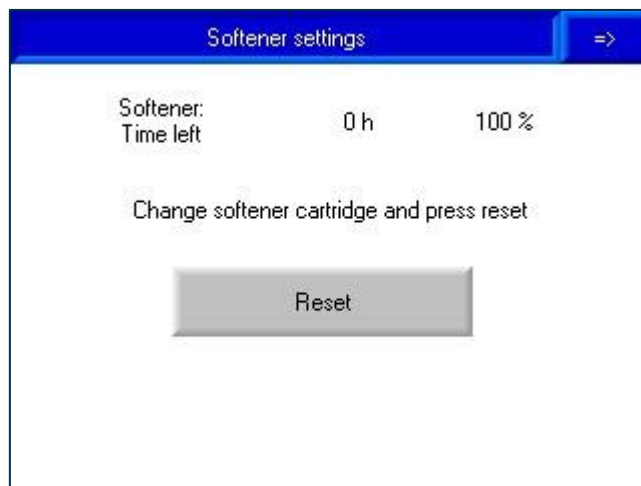

Figure 69 - Softener cartridge service

If the soft water cartridge is not changed, but the alarm reset anyway, the cell will become scaled and an alarm for low salt will appear.

8.4 Machine and Work Area - Order and Cleaning

To ensure the correct functions and usage of the BWT Desinfector, the BWT Desinfector and work area around it must be kept clean and orderly regularly.

8.5 Safety During Normal Operation

The operator is protected by the BWT Desinfector's built-in guards and functional safety solutions.

8.5.1 Test of Safety Functions

The safety function in the leak sensor should be tested approximately every six months.

1. Check that the leak sensor is functioning correctly, by gently lifting the leak sensor upward, in order to set off an alarm.
2. When alarm appears, then it must be reset and system can be started up again.
3. If an alarm is not set off, then further troubleshooting must be performed by a service technician.

8.5.2 Startup After Normal Stop

The Neuthox® production will stop when the soft water capacity in the cartridge is used. When this happens then the soft water cartridge should be flushed, before starting up the BWT Desinfecton. For flushing, see the manual for the soft water cartridge.

The system must be reset after flushing and then the size of the soft water cartridge and the water hardness must be entered in the HMI controller before startup in accordance with section 6.5.3.1.

8.5.3 Startup After Service/Repair

Is exclusively to be performed only by the installer and the service technicians.

8.6 Service, Repair and Maintenance

Any servicing or repairs, as well as maintenance beyond replenishment of consumables is to be performed by qualified service technicians. No part of the BWT Desinfecton can be serviced or repaired by the end user, other than replenishment of consumables.

8.7 Troubleshooting

If the generator is unable to continue production or dosing of Neuthox[®], a message will be shown on the display alerting the operator and providing information as to the cause.

8.7.1 Process

Message	Remedy
Yellow alerts	
Softener capacity low few days left	Plan or perform replacement of softener cartridge.
Restart after low pressure - please wait	No action required. The generator will return to the same production state as before loss of water pressure.
Manual operation activated	One or more valves, relays, pumps have been set in the "Manual operation" screen. Undo manual control before starting the process.
Water pump need service	Contact your authorized service and maintenance technician.
Brine pump need service	Contact your authorized service and maintenance technician.
Cathox pump need service	Contact your authorized service and maintenance technician.
Salt low	Refill salt soon.
Red alerts	
Process stopped Softener empty Leak alarm	Replace softener cartridge. Contact your authorized service and maintenance technician.
No softener chosen	The generator needs to know which softener system is attached, before it can start production. Tap the alert message and configure the softener.
No salt	Refill salt now.
Softener is not regenerating	Contact your authorized service and maintenance technician.
Regeneration stopped too late	Contact your authorized service and maintenance technician.
Regeneration stopped too early	Contact your authorized service and maintenance technician.
No cell current	Reset the alarm and restart. If the problem persists, contact your authorized service and maintenance technician.
Cell High current	Reset the alarm and restart. If the problem persists, contact your authorized service and maintenance technician.
High transformer or cell temperature	Reset the alarm and restart. If the problem persists, contact your authorized service and maintenance technician.

8.7.2 Dosing

Message	Remedy
Yellow alerts	
Water flow is too high	The dosing system cannot keep up with water flow. To ensure correct dosing, reduce water use.
Stopped due to salt build-up	No action required. Dosing will restart when the salt build-up has dissipated.
External stop	Release external stop.
Low level in Neuthox tank	No action required. Wait for Neuthox® tank to refill.
No use of hot water dosing stopped	No action required. Dosing will restart once hot water use resumes.
ORP level is too low	No action required. Informational only: The ORP level has fallen too far below the SP.
ORP level is too high	No action required. Informational only: The ORP level is too far above the SP.
Decrease the dosing pr. puls by a factor 5-10	The combination of the desired dosing and the water meter input requires a larger volume pr. pulse to dosing pump. See 5.2.12.1 for details on how to adjust.
Missing dosing pump settings	Dosing has been activated but not configured. Tap the alert message and configure dosing as described in 5.2.11.
Red alerts	
ORP sensor wrong value	Contact your authorized service and maintenance technician.
Dosing error. Pumping air	Verify that the hose from the Neuthox® tank to the dosing pump is in good condition and that all connections are tight; then reset the alarm and restart. If the problem persists, contact your authorized service and maintenance technician.

9 Storage/Scrapping of BWT Desinfecton

Section for when the BWT Desinfecton has passed out of commission or must be dismantled for storage.

9.1 Storage of Neuthox®

Store Neuthox® in a dry place (max. relative humidity = 75%). When Neuthox® is exposed to sunlight over a period it will disintegrate, and it can no longer be used for bacteria control and should be disposed of.

9.2 Dismantling



Disconnect the BWT Desinfecton from all supply sources.

Ensure all fluid tanks inside cabinet are empty.

Unscrew mounting brackets from wall or dismount BWT Desinfecton from mounting rack.

9.2.1 Safety When Dismantling

	CAUTION	
<p>Always disconnect water and power supply before working inside the BWT Desinfecton. Dismantle and handle with care for own safety.</p>		

	WARNING	
<p>Dismounting the BWT Desinfecton is a two persons' job. Do not try to mount it alone. Dismantle and handle with care for own safety.</p>		

9.3 Transportation

In case transportation of the BWT Desinfecton is necessary, please fasten it up right on a transport pallet. In case an upright position is not possible, the tank must be emptied.

There are no restrictions for transportation of the Neuthox®.

9.4 Scrapping of the BWT Desinfecton and Neuthox®

The BWT Desinfecton or parts of it must be sorted and disposed off in accordance with applicable national and regional regulations regarding health, safety, and the environment.



Use appropriate waste collection services, and if this is not possible, then contact the BWT ECA-machine seller in corresponding country.

The Neuthox® is produced from Sodium Chloride and tap water and should be disposed of according to Material Safety Datasheet (MSDS) for Sodium Chloride. Waste disposal should be in accordance with regulations, and contaminated packaging should be disposed of according to local regulations.

10 Appendix 1 – Modbus

10.1 Remote start and stop

Address	Function
MB2500	Start production of Neuthox®
MB2501	Stop production of Neuthox®
MB2502	Reset alarm See caution below!
MB2503	Start dosing of Neuthox®
MB2504	Stop dosing of Neuthox®

	CAUTION	
Resetting an alarm without understanding and acting upon the cause of alarm may cause damage.		

Process information

Address	Parameter	Unit	Comments
MI2500	Water flow	L/h	
MI2502	Cell current	A	Divide by 100 to get actual value
MI2504	Temperature	°C	Divide by 10 to get actual value
MI2505	Brine flow	mL/h	
MI2506	ORP	mV	
MI2508	Operating hours	h	
MI2509	Softener capacity	%	
MI2512	Operating hours × 10 000	h	
MI2513	Dosing pump flow	mL/h	
MI2514	ORP setpoint	mV	
MI2515	Chloride in water	mg/L	
MI2519	Production status		See table below for explanation
MI2530	Total Neuthox® injection	L	
MI2531	Total Neuthox® injection	m ³	
MI2532	Total Neuthox® production	L	
MI2533	Total Neuthox® production	m ³	
MI2534	Total water usage	L	
MI2535	Total water usage	m ³	
MI2536	Total water usage	1 000 m ³	
MI2540	Dosing status		See table below for explanation

10.2 MI2519 – Neuthox® production process status

Value	Explanation
0	Process stopped but ready
1	Process running – below min. level
2	Process stopped by Neuthox® level
3	Process running – above min. level
4	No capacity left in softener – process stopped
5	Low capacity left in softener – process will stop soon
6	Restarting after pressure loss
7	Leak
8	Manual operation
9	No softener chosen
10	The water pump needs service
11	The brine pump needs service
12	The cathox pump needs service
13	No salt – process stopped
14	Low salt – process will stop soon
15	Softener is not regenerating
16	Softener regeneration took longer than expected
17	Softener regeneration was quicker than expected
18	No cell current
19	High cell current
20	High temperature in transformer or cell

10.3 MI2540 – Neuthox® dosing status

Value	Explanation
0	Dosing system off
1	Dosing system on
2	Water flow is too high
3	Salt build-up in water – dosing stopped
4	Dosing stopped by external control
5	Low neuthox® level
6	No hot water use – dosing stopped
7	ORP below acceptable range
8	ORP above acceptable range
9	Wrong value from ORP sensor
10	Dosing pump vol/puls setting too high
11	Dosing system not active
12	Dosing pump settings missing
13	Dosing pump sucking air

11 Appendix 2 – Documentation

11.1 BWT Documentation

- BWT Desinfector – Maintenance Instructions
- Electrical Circuit Diagram

11.2 3rd Party Documentation

- Manual for soft water cartridge (Delivered by vendor and comes with the equipment)
- Manual for the supplied dosing pump – if any.