

BWT CRU 38, 200, 600
Concentrate Reusable Unit

For You and Planet Blue.

Content

1	General information	3
2	Explanation of words	3
3	Functional description	3
4	Installation of BWT Compact CRU	4
4.1	Positioning	4
4.2	Water connections	4
4.3	Electric installation	4
5	Start and operation of BWT CRU	5
6	Technical specifications and settings.....	5
7	Survey of alarm conditions settings	6
7.1	Trouble shooting	7
8	Technical specifications	9
9	Annex	10
9.1	El-diagram	10
9.2	PI diagram	12
9.3	Arrangement drawing	13
9.3.1	Arrangement drawing: BWT CRU 38, 200, 600	13
9.4	Start-up test	14
9.5	Spare parts drawings	15
9.5.1	Spare parts drawing: BWT CRU 38, 200, 600	15
9.6	Spare parts list BWT CRU	16
10	Disposal	17
11	Declaration of Conformity.....	18

1 General information

This operating and maintenance manual applies to BWT CRU.

This manual should be read carefully prior to installation and commissioning of the BWT CRU.

Important! Enclosed "Start-up test"(section 9.4) shall be completed.

Correct installation and operation is a condition for our 12-month warranty.

With its compact and complete design, the BWT CRU is easy to install as all internal installations have been pre-assembled and tested in our workshop.

The BWT CRU is designed for minimum service and for long and unproblematic operation. This, however, is determined by correct installation and maintenance.

2 Explanation of words

There will be a few technical explanations in this manual, which we describe below.

CRU: Concentrate Reusable Unit

Concentrate: Is the water that is led to outlet or to BWT CRU. This water contains the salts and minerals that have been removed from the raw water.

Raw water: Is the water which is led directly to RO-plant and which must be desalinated in the RO-plant.

Membranes: Is the filter of the plant which by high pressure and flow is capable of desalinating the raw water.

RO: The abbreviation for Reverse Osmosis.

Transport pump: Is the pump which transports the treated water from the tank to the consumer.

Level switch: Is a switch, which gives a signal when the RO-plant must either be started or stopped, and it stops the transport pump in case of dry-running of the tank.

3 Functional description

The BWT CRU is a unit that reuses concentrate for flushing water. In this way the BWT CRU will reduce water wastage and increase WCF (Water Conversion Factor) of the RO plant significantly.

Note! Concentrate contains a high percentage of salts and minerals for which reason it is not recommended to be used as drinking water.

BWT CRU is equipped with a 38, 200 or 600l tank with built-on level measurement and pump section. The level switch controls start and stop of the transport pump. The unit has a built-in protection against dry-running of the transport pump. The pump section consists of a transport pump which is equipped with a solenoid valve at the raw water inlet and a pressure switch and hydrophore at the outlet. When there is concentrate in the tank and the pressure switch detects a drop in the pressure, the transport pump will start, i.e. when there is a request for water. The pump stops when the pressure increases. The hydrophore equalizes pressure surges at start and stop of the pump. The non-return valve protects against air getting into the system. When tank is full with concentrate and there is no water consumption the incoming concentrate will be led to the drain through the overflow branch (on the backside of the unit). Note! The overflow branch must be connected to the

drain with the drain hose before taking BWT CRU in use.

4 Installation of BWT CRU

4.1 Positioning

The BWT CRU must be placed in frost-free surroundings on a level foundation. The foundation shall be able to carry a weight load of 78, 250 or 670 kg. The weight load of any other plants should also be taken into account!

Important! There must be free space at either side of the unit for water installations. In case of a stoppage, a situation may occur where the concentrate level in the unit overflows. There must always be a floor drain nearby, located so that the water cannot cause damage. There must be easy access to the main switch of the plant.

4.2 Water connections

Note! All water connections of the unit shall be installed in compliance with local regulations. (DS439)

Concentrate inlet: 12 mm hose
 Raw water inlet: 3/4" male thread
 Outlet: 3/4" male thread
 Drain: 1 1/4" hose

Important! If the water connection for consumption is too small there is a risk of outage on the unit due to lacking water pressure/amount. In general, pressure losses should be minimized.

Important! Concentrate can accelerate corrosion or deposit scaling in the water system. Therefore, always use corrosion-proof piping for the concentrate, e.g. stainless steel or PVC pipe.

Important! There must be an air gap (min. 20mm) between the drain hose and drain water level, or else drain water can be sucked back into the tank.

Important! The drain hose may never be bent or in any other way obstructed, as this can cause water overflow in the tank.

Important! The pressure switch on the BWT CRU, shall be regulated to match the inlet pressure in the general water system

4.3 Electric installation

Note! The electric connections must be made in compliance with local regulations. The electric connection to the BWT CRU must be as follows:

Voltage: 230 V/50 Hz
 Fuse: 10A
 Max. power consumption: 1.0 kW

Colour code of power cable:

Blue wire: N
 Brown wire: L
 Yellow/green wire: PE

5 Start and operation of BWT CRU

Note! Check before start-up that all water and electrical connections are made as described in the previous sections and that they are in compliance with local regulations.

The transport pump pressure switch and pressure tank are preset in our factory and do not need to be adjusted.

- Make sure that the overflow branch is connected to the drain and there is concentrate flow (max. 400l/h) from BWT RO plant in to the BWT CRU
- Power ON the BWT CRU and check that the transport pump motor is running. Note! The transport pump cannot be started until the tank of the unit has been filled up.
- Wait for the tank to be completely filled. Check that level switch stops the transport pump automatically when the tank is full. NOTE: Do not touch the level switch.
- Create a large consumption of water for 5 min (the TP-pump needs to be bled of air)
- Check that the transport pump starts automatically.
- Check that the pump supplies water and pressure. If the pump does not supply water and pressure, see Chapter 8: Troubleshooting.

- When the transport pump is found to be working properly, consumption of concentrate shall be stopped.
- Wait for the transport pump to stop automatically. Note! (on BWT RO reservoir and BWT CRU units): The transport pump doesn't stop until 10-30 sec. after the consumption has stopped due to the built-in time delay in the control box.
- The BWT CRU has now been commissioned and is ready for use.

6 Technical specifications and settings

It is possible to change the various time settings for Start, Stop and Alarm, plus delayed start-up of pumps.

Use of DIP-switch:

No. 1: (Only available for PERMAQ COMPACT 41)

No. 2: Transport pump

No. 3: Selection of BWT CRU model













No. 4-6: Transport pump



FACTORY SETTING

DEL / OFF 5 SECONDS		DEL / ON 15 SECONDS
ALARM / OFF NO ALARM		ALARM / ON STOP AFTER 20 MINUTES
MODEL / OFF PERMAQ COMPACT 41		MODEL / ON PERMAQ COMPACT CRU
		2 / ON 20 SECONDS START MAX. 60 PR. HOUR
		4 / ON 20 SECONDS START MAX. 90 PR. HOUR
		8 / ON 30 SECONDS START MAX. 109 PR. HOUR
		16
		32

7 Survey of alarm conditions settings

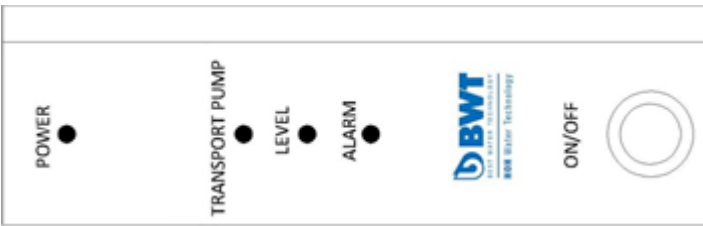
LED function: In normal operation the LED's are lit corresponding to the components they represent. Fault conditions are described in Chapter 8. Trouble shooting

				"Re-start ALARM" on TP-pump: (Nothing is working – permanent condition)	See: Fault 4
				ALARM - Too high water level: (Nothing is working – permanent condition)	Option
				Too low water level: (no ALARM, TP-pump stopped)	See: Fault 1
				External stop - TP-pump, can be jumped at start-up	Remove the cause for external stop signal
				CRU unit is running, everything OK	
				CRU unit is on Standby	
POWER	TRANSPORT PUMP (TP-pump)	LEVEL	ALARM	Description of alarm- and fault conditions	Trouble-shooting/ comments
					

		
LED's are lit	LED's flashes slowly (1/2 Hz)	LED's flashes rapidly (5 Hz)

The unit emits beep tone at Alarm condition (Nothing is working), which can only be neutralized by rectifying the fault, then switching the plant OFF for 5 seconds and switching ON again.

7.1 Trouble shooting

This chapter deals with problems that may occur on the plant. Follow the instructions in the relevant flow diagrams in order to perform a troubleshooting. **Warning!** ALWAYS pull the POWER PLUG before replacement of electrical components and wait 3 minutes.

Description of fault	Reason for fault	Action
<p>Fault 1: The tank is empty</p>	<ul style="list-style-type: none"> • Low water level. 	<ul style="list-style-type: none"> • Check that the RO-plant is running and there is flow of concentrate to the BWT CRU. The RO-plant may produce less concentrate than there is need of for consumption. • Check if too many consumers are connected on the BWT CRU and switch some off. Let the BWT CRU become completely filled up. • Check if the level switch float is stuck in top of the reservoir. Carefully push the level switch float up/down so that it is at concentrate water level. • Check if the level switch and/or the level switch cable are defective. If so, replace. • Check the TP-pump (See Fault 1, Fault 2 and Fault 3).
<p>Fault 2: TP pump doesn't run</p>	<ul style="list-style-type: none"> • Switch is at OFF. 	<ul style="list-style-type: none"> • Push switch to ON.
	<ul style="list-style-type: none"> • Low water level. 	<ul style="list-style-type: none"> • Let the reservoir become completely filled up and the TP pump will start automatically.
	<ul style="list-style-type: none"> • Defective pressure switch. 	<ul style="list-style-type: none"> • Short the pressure switch by making a jumper between the two plugs. If the pump only runs when this jumper is connected and there is a request for water, then the pressure switch is defective and must be replaced.
	<ul style="list-style-type: none"> • Defective capacitor. 	<ul style="list-style-type: none"> • Locate transport pumps capacitor in the control box and replace it.
	<ul style="list-style-type: none"> • Defective fuse. 	<ul style="list-style-type: none"> • Check the PCB and replace the fuse (F3-Circuit Board) of the TP pump.
	<ul style="list-style-type: none"> • Defective TP-pump. 	<ul style="list-style-type: none"> • Replace TP-pump.
	<ul style="list-style-type: none"> • Defective PCB. 	<ul style="list-style-type: none"> • Replace PCB.
	<ul style="list-style-type: none"> • Float of the level switch is stuck. 	<ul style="list-style-type: none"> • Push the level switch float carefully up/down until it is at concentrate level.
	<ul style="list-style-type: none"> • Defective level switch. 	<ul style="list-style-type: none"> • Replace level switch.
<ul style="list-style-type: none"> • External stop signal on the TP-pump. 	<ul style="list-style-type: none"> • Check and rectify cause of the external stop signal. 	

Fault 3: TP-pump is running but no water is getting to the consumer	<ul style="list-style-type: none"> • Air in the TP-pump. 	<ul style="list-style-type: none"> • The TP-pump needs to be bled of air. Switch power OFF, fill up the tank and turn switch power back to ON. Let the pump run a while with a <u>large flow</u> in order to get the remaining air out of the pump case.
	<ul style="list-style-type: none"> • Low water level. 	<ul style="list-style-type: none"> • Disconnect the consumer. Let the tank become completely filled and the TP-pump will start automatically.
Fault 4: TP-pump starts and stops	<ul style="list-style-type: none"> • If the piping connection is too small there is a risk of outages on the plant due to lacking water pressure/amount etc. 	<ul style="list-style-type: none"> • Replace the outlet pipe (water for consumption) with an outlet pipe with a larger dimension.
	<ul style="list-style-type: none"> • Non-return valve is leaks/defective. 	<ul style="list-style-type: none"> • Replace the non-return valve.
	<ul style="list-style-type: none"> • The hydrophore is defective or lacking air. 	<ul style="list-style-type: none"> • Replace the pressure tank and set the pre-pressure at 2.7 bar.
	<ul style="list-style-type: none"> • The hydrophore capacity is too small. 	<ul style="list-style-type: none"> • Contact BWT for technical advice.
	<ul style="list-style-type: none"> • Pressure switch set incorrectly. 	<ul style="list-style-type: none"> • Set the pressure switch at 4.0 bar (Stop) and 3.0 bar (Start).

8 Technical specifications

BWT CRU				
Designation	Tag number	CRU 38	CRU 200	CRU 600
Tank volume		38 l	200 l	600 l
Max. concentrate flow to the CRU		400 l/h	400 l/h	400 l/h
Transport pump	P1	0.85 kW, 4.5A	0.85 kW, 4.5A	0.85 kW, 4.5A
Pump capacity		3 bar / 3 m ³ /h	3 bar / 3 m ³ /h	3 bar / 3 m ³ /h
Height/Width/Depth		810/580/630 mm	810/580/630 mm	810/580/630 mm
Concentrate inlet, diameter		12 mm	12 mm	12 mm
Consumption water outlet, diameter		3/4"	3/4"	3/4"
Raw water inlet, diameter		3/4"	3/4"	3/4"
Weight (empty/full)		30/78 kg	50/250 kg	70/670 kg
Water temperature (Min./Max.)		5-35°C	5-35°C	5-35°C
Pressure switch	PS01	-0.2 to 8 bar	-0.2 to 8 bar	-0.2 to 8 bar
Solenoid valve, NO	V1	POM	POM	POM
Non-return valve	V2, V3	1/2"	1/2"	1/2"
Overflow, diameter		1"	1"	1"

9 Annex

9.1 El-diagram

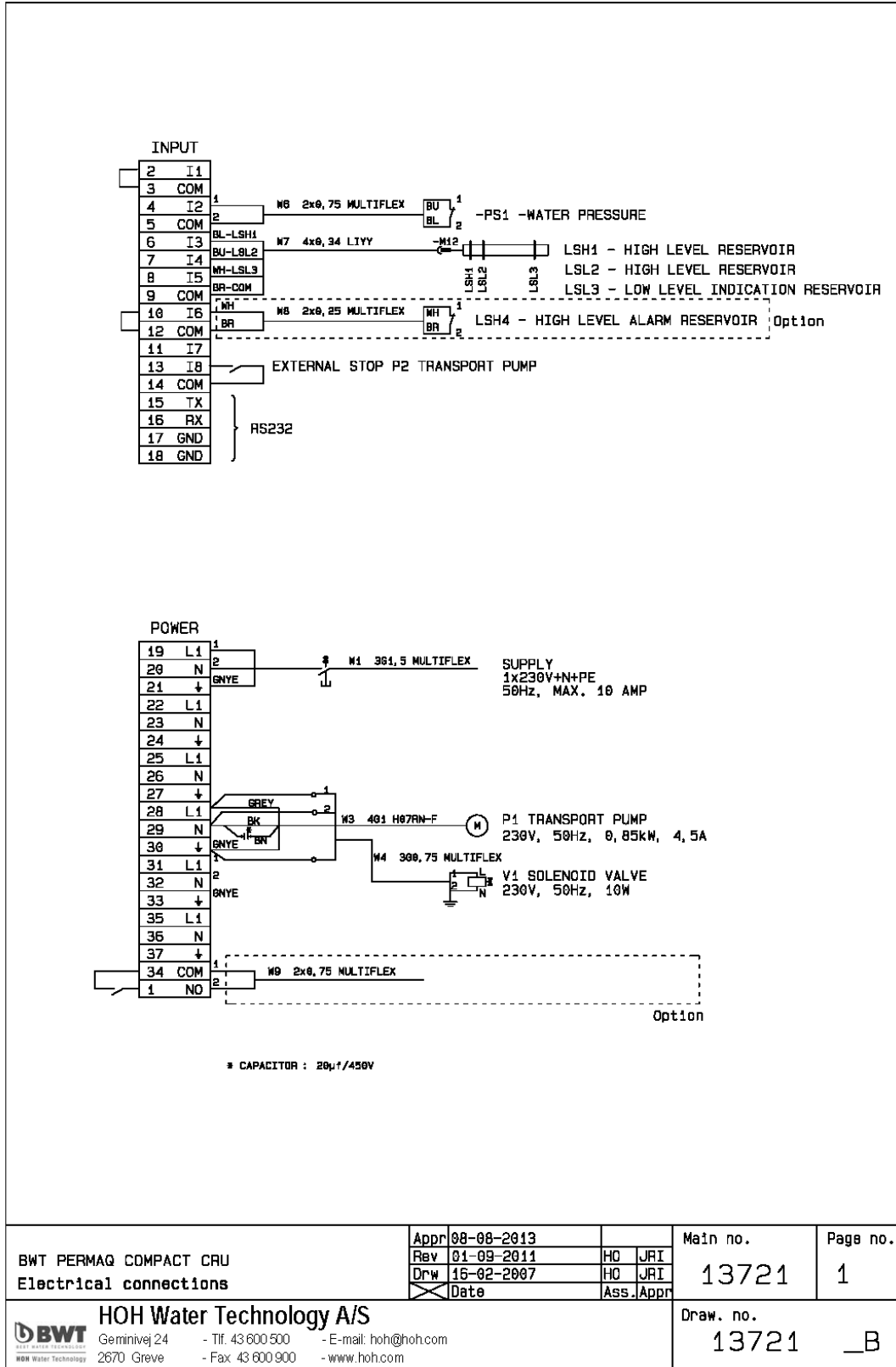

BWT PERMAQ COMPACT CRU Electrical connections	Appr	08-08-2013		Main no.	Page no.
	Rev	01-09-2011	HO JRI		
	Drw	15-02-2007	HO JRI	13721	1
	Date		Ass.Appr		
HOH Water Technology A/S Geminivej 24 - Tlf. 43 600 500 - E-mail: hoh@hoh.com 2670 Greve - Fax 43 600 900 - www.hoh.com			Draw. no. 13721 _B		

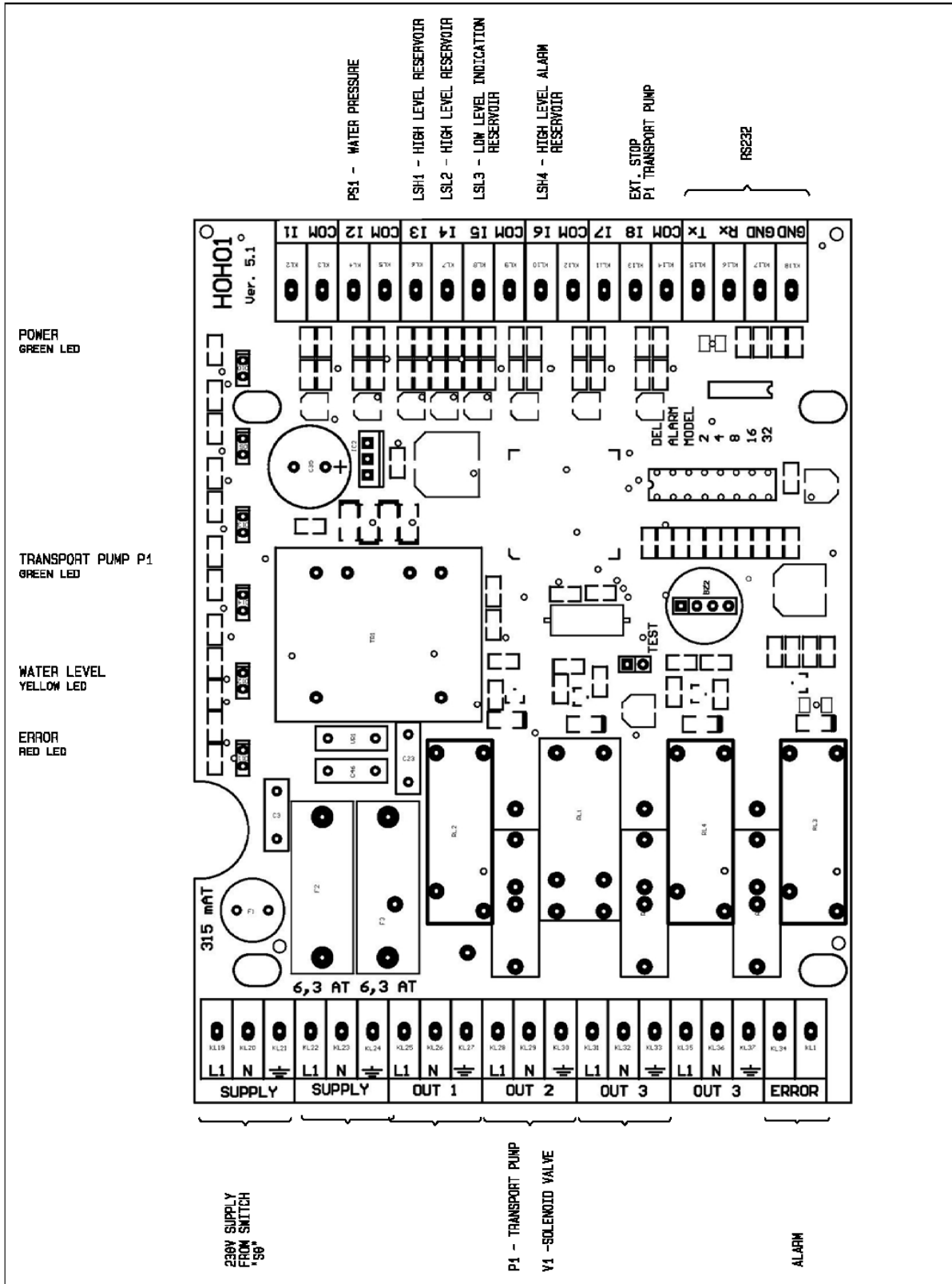

BWT PERMAQ COMPACT CRU Circuit board	Appr	08-08-2013		Main no. 13721	Page no. 2
	Rev	16-11-2009	HO JRI		
	Drw	11-06-2007	HO JRI	Draw. no. 13721	_B
	Date		Ass.Appr		

HOH Water Technology A/S
 Geminivej 24 - Tlf. 43 600 500 - E-mail: hoh@hoh.com
 2670 Greve - Fax 43 600 900 - www.hoh.com

9.2 PI diagram

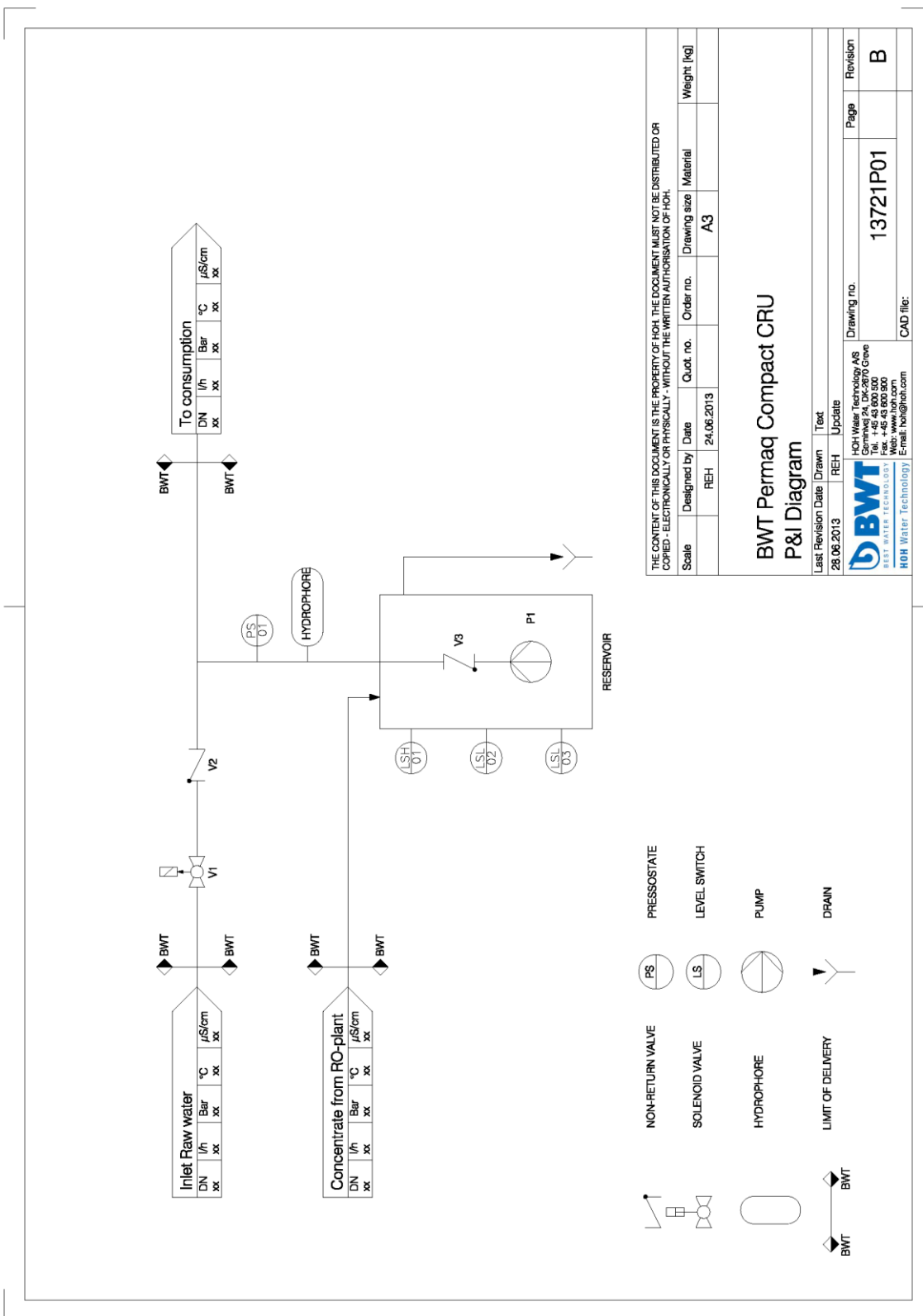

9.3 Arrangement drawing

9.3.1 Arrangement drawing: BWT CRU 38, 200, 600

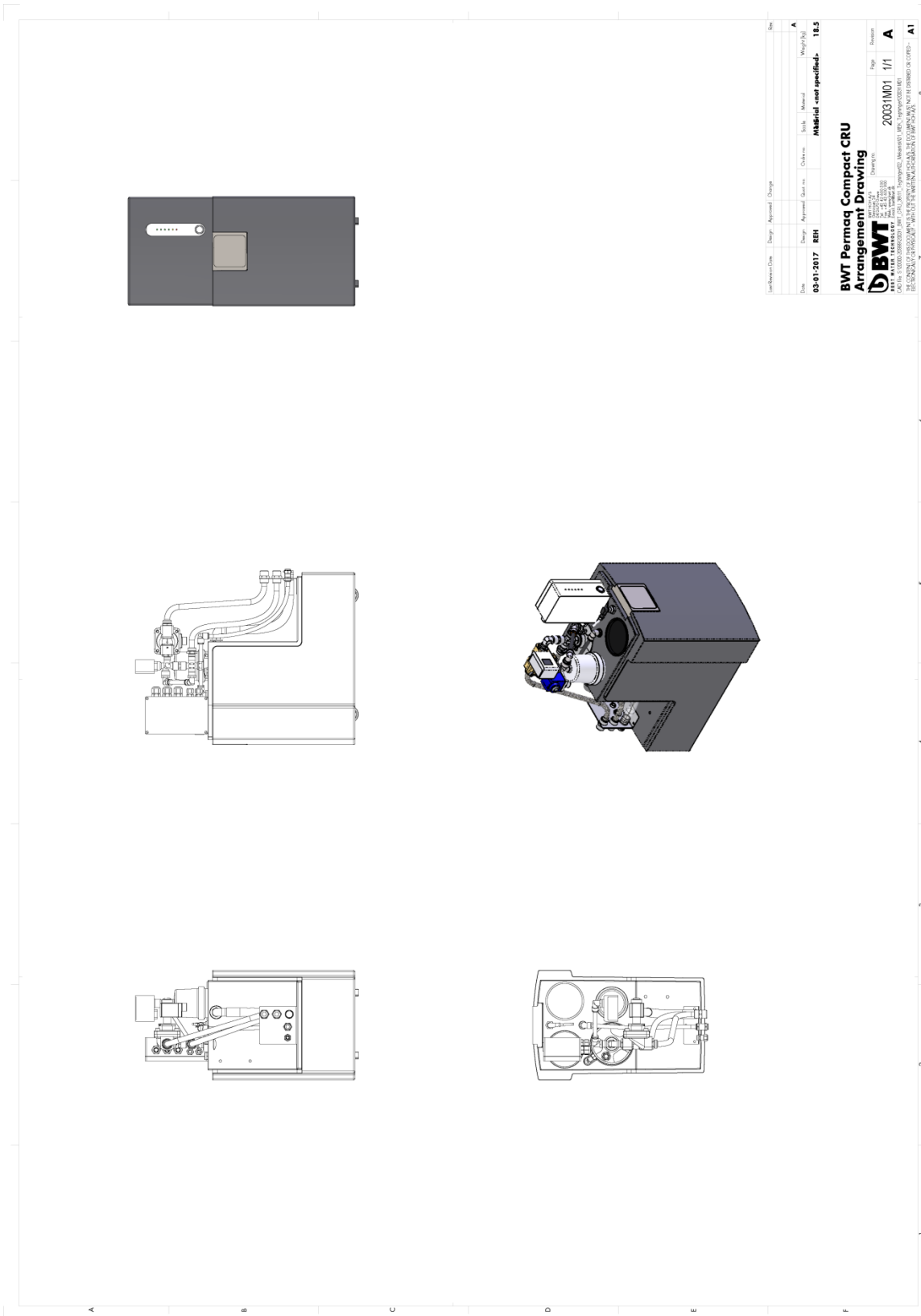

9.4 Start-up test

The start-up test sheet must be completed and filed together with the operating journal.		
Name of customer:	Plant number:	Work-sheet number:
RO plant		
Type of plant:	Permeate flow [l/h]:	Concentrate flow [l/h]:
BWT PERMAQ Compact CRU		
<input type="checkbox"/> Drainage protection, overflow branch is connected to the drain	<input type="checkbox"/> Pressure switch start/stop, transport pump is OK	
<input type="checkbox"/> Max. concentrate flow from RO to the CRU is < 500 [l/h]	<input type="checkbox"/> Pre-pressured hydrophore is OK	
Status on start-up		
<input type="checkbox"/> Start-up by BWT	<input type="checkbox"/> Start-up by dealer, specify dealer _____	
Problems on start-up		
<input type="checkbox"/> YES, there were problems at start-up	<input type="checkbox"/> NO, there were no problems at start-up	
<i>In case of problems, please fill in the problem report</i>		
Problem report		
Can the problem be related to the manufacturing?		
<input type="checkbox"/> YES, the problem can be related to the manufacturing	<input type="checkbox"/> NO, the problem cannot be related to the manufacturing	
Can the problem be related to the plant or the installation?		
<input type="checkbox"/> YES, the problem only concerns the plant	<input type="checkbox"/> YES, the problem only concerns the installation	
<input type="checkbox"/> YES, the problem concerns both the plant and the installation	<input type="checkbox"/> NO, the problem does not concern the plant or the installation	
The plant - we mean only the part of the whole installation which was delivered by BWT (i.e. only the plant). The installation - we mean the piping etc. leading to the plant.		
Can the problem be related to the sales department?		
<input type="checkbox"/> YES, the customer was misinformed	<input type="checkbox"/> NO, the customer had been well-informed	
Description, please describe the problem		
Signature		
Name/initials of technician:	Date:	Time consumption for the start-up [hours]:

9.6 Spare parts list BWT CRU

Pos. Nr.	BWT CRU	Recommended spare parts	Spare part No.	Recommended replacement frequency
1	Transport pump		454100070	
2	12mm feedthrough		409700012	3 year
3	Hose 400 mm		451404189	
4	Push-in fitting 12x12, Elbow		454090012	3 year
5	½" Non-return valve		200729004	
6	Magnetic valve housing		200753004	
7	Wheels		403899070	
8	Level Switch		451404430	
9	Hydrophore 0.5 liter		451404571	3-5 year
10	Coil		200753100	
11	Push – In fitting 12x ½ , transition		454060012	
12	Control Box complete		451404417	
	PCB		*	
-	20 µF Capacitor (Transport pump motor)	1	750001270	
-	Cable for level switch		451404470	
-	10 mm plastic hose		454001010	3 years

* Contact your local BWT dealer for detailed information.

10 Disposal

The packaging is to be taken to a local waste disposal site if no longer required. The packaging comprises of environmentally-friendly materials that can be used as secondary raw materials.



The device, including accessories and batteries, is not to be thrown into the household waste. EU legislation in Member States requires electrical and electronic equipment to be collected separately from unsorted municipal waste so that it may be recycled.

In Denmark and several other countries, BWT itself assumes responsibility for the return and conformant disposal of its electronic and electrical products. These products may not be placed with household waste or brought to collection centres run by local public disposal operations - not even by small commercial operators.

For disposal in Denmark and in the other member nations of the European Economic Area (EEA), please contact our local BWT service technicians or our Service Center in Greve, Denmark:

BWT HOH A/S
Geminivej 24
DK-2670 Greve

In countries that are not members of the European Economic Area (EEA) or where no BWT subsidiaries or dealerships are located; please contact your local authorities or a commercial disposal operator.

Remove the batteries and hand them in to a collection point prior to disposal/scraping of the device.

BWT, its affiliates, subsidiaries, dealers and distributors will not take back equipment contaminated with hazardous materials (ABC contamination) - neither for repair nor disposal. Please refer to our web site (www.bwt-group.com) for more detailed information regarding addresses for repair service or disposal of your device.

11 Declaration of Conformity

EC DECLARATION OF CONFORMITY FOR MACHINERY
DIRECTIVE 2006/42/EC, ANNEX II, A
LOW VOLTAGE DIRECTIVE
EMC DIRECTIVE



BWT HOH A/S
Geminivej 24 - DK-2670 Greve
tel.: +45 43 600 500 - fax: +45 43 600 900
bwt@bwt.dk - www.bwt.dk

Herewith declares that:

BWT CRU 38, 200, 600

- is in conformity with the provisions of the Machinery Directive (directive 2006/42/EC)
- is in conformity with the provisions of the following other EC directives
- Low Voltage Directive (2006/95/EC)
- EMC Directive (2004/108/EC)

Place: Greve, Denmark

Date: 03-04-2017

Lars Jensen
Head of Product Management

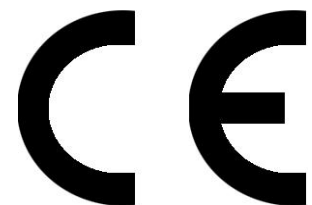

For further information, please contact

BWT HOH A/S
Geminivej 24
DK-2670 Greve
Tel : +45 43 600 500
Fax: +45 43 600 900
E-Mail: bwt@bwt.dk

BWT Austria GmbH
Walter-Simmer-Str. 4
A-5310 Mondsee
Tel : +43 6232 5011 0
Fax: +43 6232 4058
E-Mail: office@bwt.at

BWT Belgium NM.
Leuvensesteenweg 633
B-1930 Zaventem
Tel : +32 2 758 03 10
Fax: +32 2 758 03 33
E-Mail: bwt@bwt.be

BWT UK Ltd.
Coronation Road, BWT House
High Wycombe
Buckinghamshire, HP12, 3SU
Tel : +44 1494 838 100
Fax: +44 1494 838 101
E-Mail: info@bwt-uk.co.uk

Cillit S.A.
C/Silici, 71 -73
Poligono Industrial del Este
E-08940 Cornelia de Llobregat
Tel : +34 93 440 494
Fax: +34 93 4744 730
E-Mail: cillit@cillit.com

BWT Birger Christensen AS
Røykenveien 142 A
Postboks 136
N-1371 Asker
Tel : +47 67 17 70 00
Fax: +47 67 17 70 01
E-Mail: firmapost@hoh.no

BWT Wassertechnik GmbH
Industriestraße 7
D-69198 Schriesheim
Tel : +49 6203 73 0
Fax: +49 6203 73 102
E-Mail: bwt@bwt.de

BWE Česká Republika s.r.o.
Lipovo 196 -Cestlice
CZ-251 01 Říčany
Tel : +42 272 680 300
Fax: +42 272 680 299
E-Mail: info@bwt.cz

BWT Nederland B.V.
Centraal Magazijn
Energieweg 9
NI-2382 NA Zoeterwoude
Tel : +31 88 750 90 00
Fax: +31 88 750 90 90
E-Mail: sales@bwt-nederland.nl

BWT Vattenteknik AB
Box 9226
Kantygatan 25
SE-213 76 Malmö
Tel : +46 40 691 45 00
Fax: +46 40 21 20 55
E-Mail: info@vattenteknik.se

Cillichemie Italiana SRL
Via Plinio 59
I-20129 Milano
Tel : +39 02 204 63 43
Fax: +39 02 201 058
E-Mail: info@cillichemie.com

BWT Polska Sp. z o.o.
ul. Polczyhska 116
PL-01-304 Warszawa
Tel : +48 22 6652 609
Fax: +48 22 6649 612
E-Mail: bwt@bwt.pl

BWT AQUA AG
Hauptstraße 192
CH-4147 Aesch
Tel : +41 61 755 88 99
Fax: +41 61 755 88 90
E-Mail: info@bwt-agua.ch

BWT Separtec OY
PL 19 Varppeenkatu 28
FIN-21201 Raisio
Tel : +358 2 4367 300
Fax: +358 2 4367 355
E-Mail: hoh@hoh.fi

BWT France SAS
103, Rue Charles Michels
F-93206 Saint Denis Cedex
Tel : +33 1 4922 45 00
Fax: +33 1 4922 45 45
E-Mail: bwt@bwt.fr

BWT Hungária Kft.
Keleti út. 7.
H-2040 Budaörs
Tel : +36 23 430 480
Fax: +36 23 430 482
E-Mail: bwt@bwt.hu

OOO Russia BWT
Ul. Kasatkina 3A
RU-129301 Moscow
Tel : +7 495 686 6264
Fax: +7 495 686 7465
E-Mail: info@bwt.ru