



BWT PERMAQ Compact CRU

CONTENTS

1. GENERAL INFORMATION	4
2. EXPLANATION OF WORDS	4
3. FUNCTIONAL DESCRIPTION	4
4. INSTALLATION OF BWT PERMAQ COMPACT CRU	5
4.1. Positioning	5
4.2. Water connections	5
4.3. Electric installation	6
5. START AND OPERATION OF BWT PERMAQ COMPACT CRU	6
6. TECHNICAL SPECIFICATIONS AND SETTINGS	7
7. SURVEY OF ALARM CONDITIONS SETTINGS	8
8. TROUBLE SHOOTING	9
9. ANNEX	11
9.1. Technical specifications	11
9.2. P&I Diagram BWT PERMAQ Compact CRU	12
9.3. Layout	13
9.4. Electrical connections	14
9.5. PCB – circuit board	15
9.6. Start-up test	16
9.7. Spare parts list BWT PERMAQ Compact CRU	17
9.8. Spare parts overview	17
9.9. Disposal	18
9.10. Declaration of Conformity	19

1. GENERAL INFORMATION

This operating and maintenance manual applies to BWT PERMAQ Compact CRU. CRU is the abbreviation for Concentrate Reusable Unit.

This manual should be read carefully prior to installation and commissioning of the BWT PERMAQ Compact CRU.

Important! Enclosed "Start-up test"(section 9.6) shall be completed.

Correct installation and operation is a condition for our 12-month warranty.

With its compact and complete design, the BWT PERMAQ Compact CRU is easy to install as all internal installations have been pre-assembled and tested in our workshop.

The BWT PERMAQ Compact CRU is designed for minimum service and for long and unproblematic operation. This, however, is determined by correct installation and maintenance.

2. EXPLANATION OF WORDS

There will be a few technical explanations in this manual, which we describe below.

CRU: Concentrate Reusable Unit

Permeate: The treated, totally desalinated water which is produced by the RO-plant and supplied to the reservoir tank.

Concentrate: Is the water that is led to outlet or to BWT PERMAQ Compact CRU. This water contains the salts and minerals that have been removed from the raw water.

Raw water: Is the water which is led directly to RO-plant and which must be desalinated in the RO-plant.

Membranes: Is the filter of the plant which by high pressure and flow is capable of desalinating the raw water.

RO: The abbreviation for Reverse Osmosis.

Transport pump: Is the pump which transports the treated water from the tank to the consumer.

Level switch: Is a switch, which gives a signal when the RO-plant must either be started or stopped, and it stops the transport pump in case of dry-running of the tank.

3. FUNCTIONAL DESCRIPTION

The BWT PERMAQ Compact CRU is a unit that reuses concentrate for flushing water. In this way the BWT RO Compact CRU will reduce water wastage and increase WCF (Water Conversion Factor) of the RO plant significantly.

Note! Concentrate contains a high percentage of salts and minerals for which reason it is not recommended to be used as drinking water.

BWT PERMAQ Compact CRU is equipped with 100l tank with built-on level measurement and pump section. The level switch controls start and stop of the transport pump. The unit has a built-in protection against dry-running of the transport pump. The pump section consists of a

transport pump which is equipped with a solenoid valve at the raw water inlet and a pressure switch and hydrophore at the outlet. When there is concentrate in the tank and the pressure switch detects a drop in the pressure, the transport pump will start, i.e. when there is a request for water. The pump stops when the pressure increases. The hydrophore equalizes pressure surges at start and stop of the pump. The non-return valve protects against air getting into the system. When tank is full with concentrate and there is no water consumption the incoming concentrate will be led to the drain through the overflow branch (on the backside of the unit). **Note!** The overflow branch must be connected to the drain with the drain hose before taking BWT PERMAQ Compact CRU in use.

4. INSTALLATION OF BWT PERMAQ Compact CRU

4.1. Positioning

The BWT PERMAQ Compact CRU must be placed in frost-free surroundings on a level foundation. The foundation shall be able to carry a weight load of 130 kg. The weight load of any other plants should also be taken into account!

Important! There must be free space at either side of the unit for water installations. In case of a stoppage, a situation may occur where the concentrate level in the unit overflows. There must always be a floor drain nearby, located so that the water cannot cause damage. There must be easy access to the main switch of the plant.

4.2. Water connections

Note! All water connections of the unit shall be installed in compliance with local regulations.

Concentrate inlet: 10 mm hose

Raw water inlet: ½" outside thread

Outlet : ½" outside thread

Drain: 1¼" hose

Important! If the water connection for consumption is too small there is a risk of outage on the unit due to lacking water pressure/amount. In general, pressure losses should be minimized.

Important! Concentrate can accelerate corrosion. Therefore, always use corrosion-proof piping for the concentrate, e.g. stainless steel or PVC pipe.

Important! There must be an air gap between the drain hose and drain water level, or else drain water can be sucked back into the tank.

Important! The drain hose may never be bent or in any other way obstructed, as this can cause water overflow in the tank.

4.3. Electric installation

Note! The electric connections must be made in compliance with local regulations. The electric connection to the BWT PERMAQ Compact CRU must be as follows:

Voltage : 230 V/50 Hz

Fuse: 10A

Max. power consumption: 1.0 kW

Colour code of power cable:

Blue wire: N

Brown wire: L

Yellow/green wire: PE

5. START AND OPERATION OF BWT PERMAQ Compact CRU

Note! Check before start-up that all water and electrical connections are made as described in the previous sections and that they are in compliance with local regulations.

The transport pump pressure switch and pressure tank are preset in our factory and do not need to be adjusted.

- 1: Make sure that the overflow branch is connected to the drain and there is concentrate flow (max. 500l/h) from BWT RO plant in to the BWT PERMAQ Compact CRU
- 2: Power ON the BWT PERMAQ Compact CRU and check that the transport pump motor is running. **Note!** The transport pump cannot be started until the tank of the unit has been filled up.
- 3: Wait for the tank to be completely filled. Check that level switch stops the transport pump automatically when the tank is full. NOTE: Do not touch the level switch.
- 4: Create a large consumption of water for 5 min (the TP-pump needs to be bled of air)
- 5: Check that the transport pump starts automatically.
- 6: Check that the pump supplies water and pressure. If the pump does not supply water and pressure, see Chapter 8: Trouble-shooting.
- 7: When the transport pump is found to be working properly, consumption of concentrate shall be stopped.
- 8: Wait for the transport pump to stop automatically.
Note! (on BWT RO reservoir and BWT CRU units): The transport pump doesn't stop until 10-30 sec. after the consumption has stopped due to the built-in time delay in the control box.
- 9: The BWT PERMAQ Compact CRU has now been commissioned and is ready for use.

6. TECHNICAL SPECIFICATIONS AND SETTINGS

It is possible to change the various time settings for Start, Stop and Alarm, plus delayed start-up of pumps.

Use of DIP-switch:















- No. 1 (Only available for PERMAQ COMPACT 41)
- No. 2 Transport pump
- No. 3 Selection of BWT PERMAQ Compact CRU model
- No. 4-6 Transport pump



FACTORY SETTING

DEL / OFF 5 SECONDS	<input checked="" type="checkbox"/>	DEL / ON 15 SECONDS
ALARM / OFF NO ALARM	<input checked="" type="checkbox"/>	ALARM / ON STOP AFTER 20 MINUTES
MODEL / OFF PERMAQ COMPACT 41	<input type="checkbox"/>	MODEL / ON PERMAQ COMPACT CRU
	<input checked="" type="checkbox"/>	2 / ON 20 SECONDS START MAX. 60 PR. HOUR
	<input checked="" type="checkbox"/>	4 / ON 20 SECONDS START MAX. 90 PR. HOUR
	<input type="checkbox"/>	8 / ON 30 SECONDS START MAX. 109 PR. HOUR
	<input checked="" type="checkbox"/>	16
	<input checked="" type="checkbox"/>	32

7. SURVEY OF ALARM CONDITIONS SETTINGS

LED function: In normal operation the LED's are lit corresponding to the components they represent. Fault conditions are described in Chapter 8. Trouble shooting

				"Re-start ALARM" on TP-pump: (Nothing is working – permanent condition)	See: Fault 4
				ALARM - Too high water level: (Nothing is working – permanent condition)	Option
				Too low water level: (no ALARM, TP-pump stopped)	See: Fault 1
				External stop - TP-pump, can be jumped at start-up	Remove the cause for external stop signal
				CRU unit is running, everything OK	
				CRU unit is on Standby	
POWER	TRANSPORT PUMP (TP-pump)	LEVEL	ALARM	Description of alarm- and fault conditions	Trouble-shooting/ comments
					

		
LED's are lit	LED's flashes slowly (1/2 Hz)	LED's flashes rapidly (5 Hz)

The unit emits beep tone at Alarm condition (Nothing is working), which can only be neutralized by rectifying the fault, then switching the plant OFF for 5 seconds and switching ON again.

8. TROUBLE SHOOTING

This chapter deals with problems that may occur on the plant. Follow the instructions in the relevant flow diagrams in order to perform a troubleshooting. **Warning!** ALWAYS pull the POWER PLUG before replacement of electrical components and wait 3 minutes.

Description of fault	Reason for fault	Action
<p>Fault 1: The tank is empty</p>	<ul style="list-style-type: none"> • Low water level. 	<ul style="list-style-type: none"> • Check that the RO-plant is running and there is flow of concentrate to the BWT PERMAQ Compact CRU. The RO-plant may produce less concentrate than there is need of for consumption. • Check if too many consumers are connected on the BWT PERMAQ Compact CRU and switch some off. Let the BWT PERMAQ Compact CRU become completely filled up. • Check if the level switch float is stuck in top of the reservoir. Carefully push the level switch float up/down so that it is at concentrate water level. • Check if the level switch and/or the level switch cable are defective. If so, replace. • Check the TP-pump (See Fault 1, Fault 2 and Fault 3).
<p>Fault 2: TP pump doesn't run</p>	<ul style="list-style-type: none"> • Switch is at OFF. 	<ul style="list-style-type: none"> • Push switch to ON.
	<ul style="list-style-type: none"> • Low water level. 	<ul style="list-style-type: none"> • Let the reservoir become completely filled up and the TP pump will start automatically.
	<ul style="list-style-type: none"> • Defective pressure switch. 	<ul style="list-style-type: none"> • Short the pressure switch by making a jumper between the two plugs. If the pump only runs when this jumper is connected and there is a request for water, then the pressure switch is defective and must be replaced.
	<ul style="list-style-type: none"> • Defective capacitor. 	<ul style="list-style-type: none"> • Locate transport pumps capacitor in the control box and replace it.
	<ul style="list-style-type: none"> • Defective fuse. 	<ul style="list-style-type: none"> • Check the PCB and replace the fuse (F3-Circuit Board) of the TP pump.
	<ul style="list-style-type: none"> • Defective TP-pump. 	<ul style="list-style-type: none"> • Replace TP-pump.

	<ul style="list-style-type: none"> • Defective PCB. 	<ul style="list-style-type: none"> • Replace PCB.
	<ul style="list-style-type: none"> • Float of the level switch is stuck. 	<ul style="list-style-type: none"> • Push the level switch float carefully up/down until it is at concentrate level.
	<ul style="list-style-type: none"> • Defective level switch. 	<ul style="list-style-type: none"> • Replace level switch.
	<ul style="list-style-type: none"> • External stop signal on the TP-pump. 	<ul style="list-style-type: none"> • Check and rectify cause of the external stop signal.
Fault 3: TP-pump is running but no water is getting to the consumer	<ul style="list-style-type: none"> • Air in the TP-pump. 	<ul style="list-style-type: none"> • The TP-pump needs to be bled of air. Switch power OFF, fill up the tank and turn switch power back to ON. Let the pump run a while with a <u>large flow</u> in order to get the remaining air out of the pump case.
	<ul style="list-style-type: none"> • Low water level. 	<ul style="list-style-type: none"> • Disconnect the consumer. Let the tank become completely filled and the TP-pump will start automatically.
Fault 4: TP-pump starts and stops	<ul style="list-style-type: none"> • If the piping connection is too small there is a risk of outages on the plant due to lacking water pressure/amount etc. 	<ul style="list-style-type: none"> • Replace the outlet pipe (water for consumption) with an outlet pipe with a larger dimension.
	<ul style="list-style-type: none"> • Non-return valve is leaky/defective. 	<ul style="list-style-type: none"> • Replace the non-return valve.
	<ul style="list-style-type: none"> • The hydrophore is defective or lacking air. 	<ul style="list-style-type: none"> • Replace the hydrophore and set the pre-pressure at 2.7 bar.
	<ul style="list-style-type: none"> • The hydrophore capacity is too small. 	<ul style="list-style-type: none"> • Contact BWT for technical advice.
	<ul style="list-style-type: none"> • Pressure switch set incorrectly. 	<ul style="list-style-type: none"> • Set the pressure switch at 4.0 bar (Stop) and 3.0 bar (Start).

9. ANNEX

9.1. Technical specifications

BWT PERMAQ Compact CRU		
Designation	Tag number	Type/data
Tank volume		100 l
Max. concentrate flow to the CRU		500 l/h
Transport pump	P1	0.85 kW, 4.5A
Pump capacity		3 bar / 3 m ³ /h
Height/Width/Depth		810/580/630 mm
Concentrate inlet, diameter		10 mm
Consumption water outlet, diameter		½"
Raw water inlet, diameter		½"
Weight (empty/full)		30/130 kg
Water temperature (Min. /Max.)		5-35°C
Pressure switch	PS01	-0.2 to 8 bar
Solenoid valve, NO	V1	POM
Non-return valve	V2, V3	½"

9.2. P&I Diagram BWT PERMAQ Compact CRU

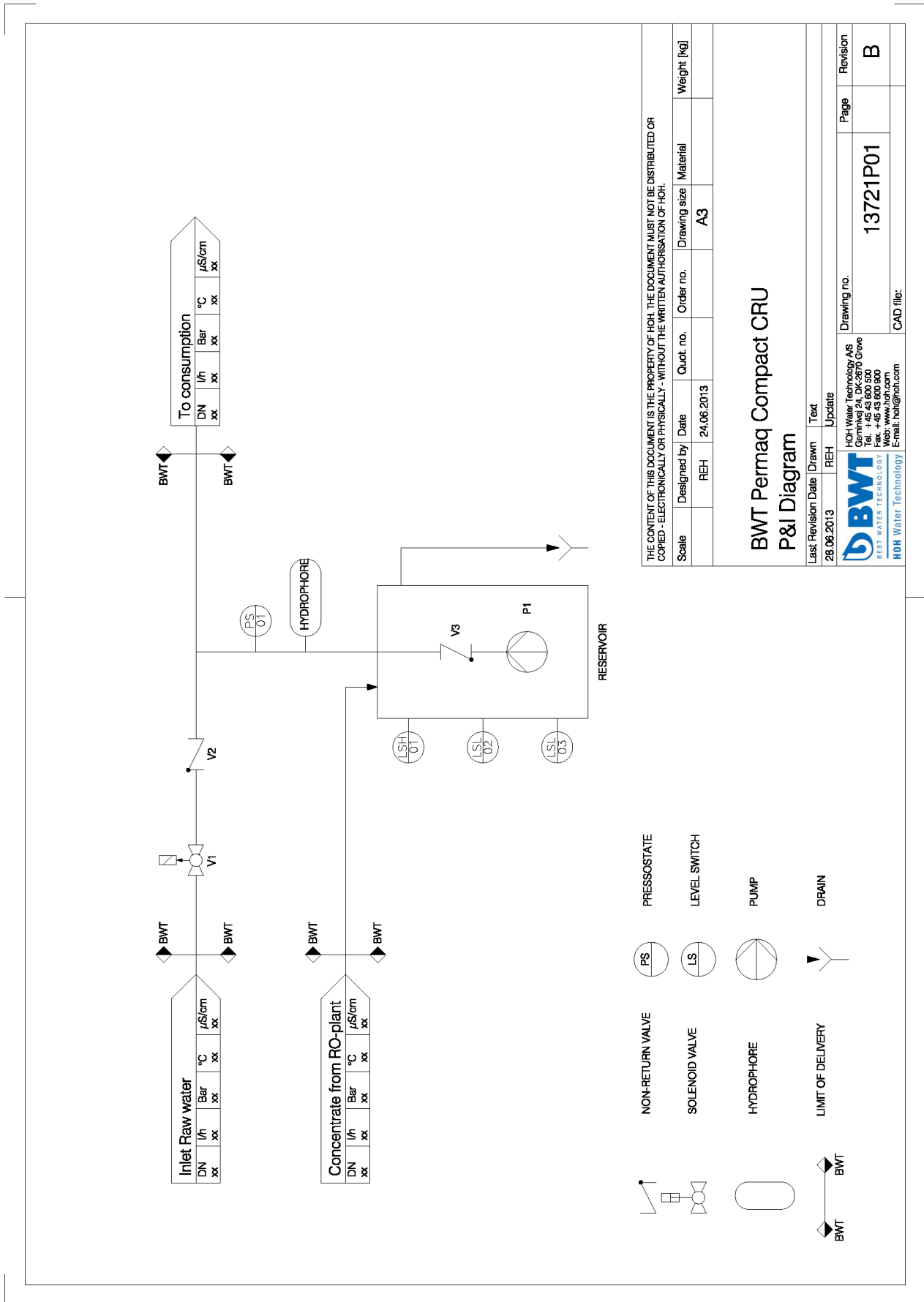

9.3. Layout



Front side of the unit



Back side of the unit

- A: ON/OFF switch
- B: Control box
- C: Wheels
- D: Concentrate inlet
- E: Raw water inlet
- F: Outlet consumption
- G: Overflow branch
- H: Pressure switch
- I: Solenoid valve
- J: Hydrophore
- K: Transport pump
- L: Level switch
- M: Non-return valve
- N: Handle for moving the unit
- O: Tank lid
- P: Unit lid

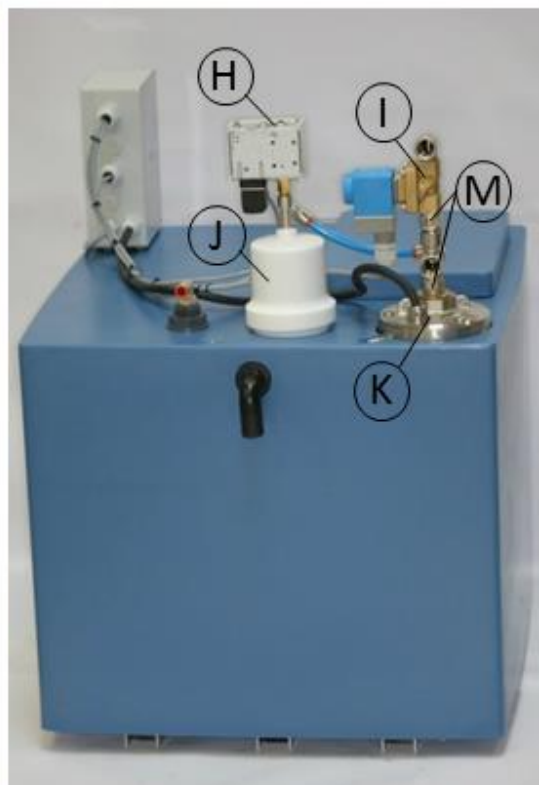
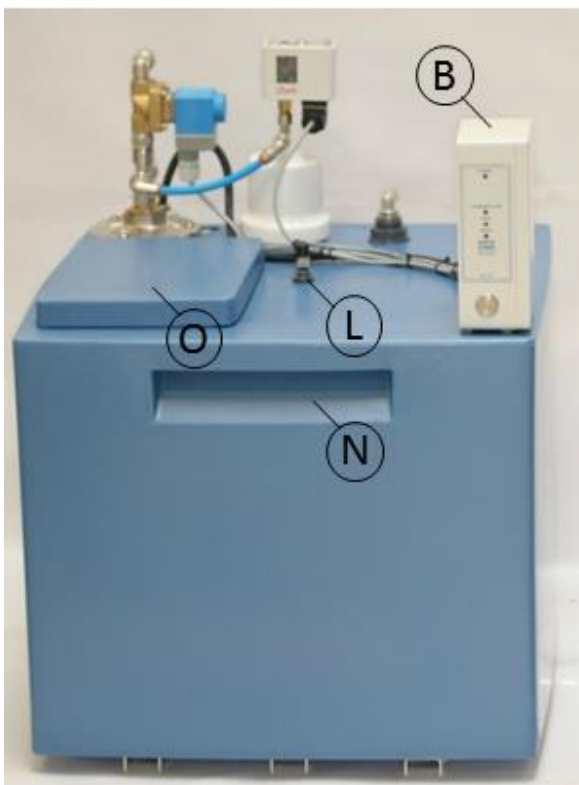

9.4. Electrical connections

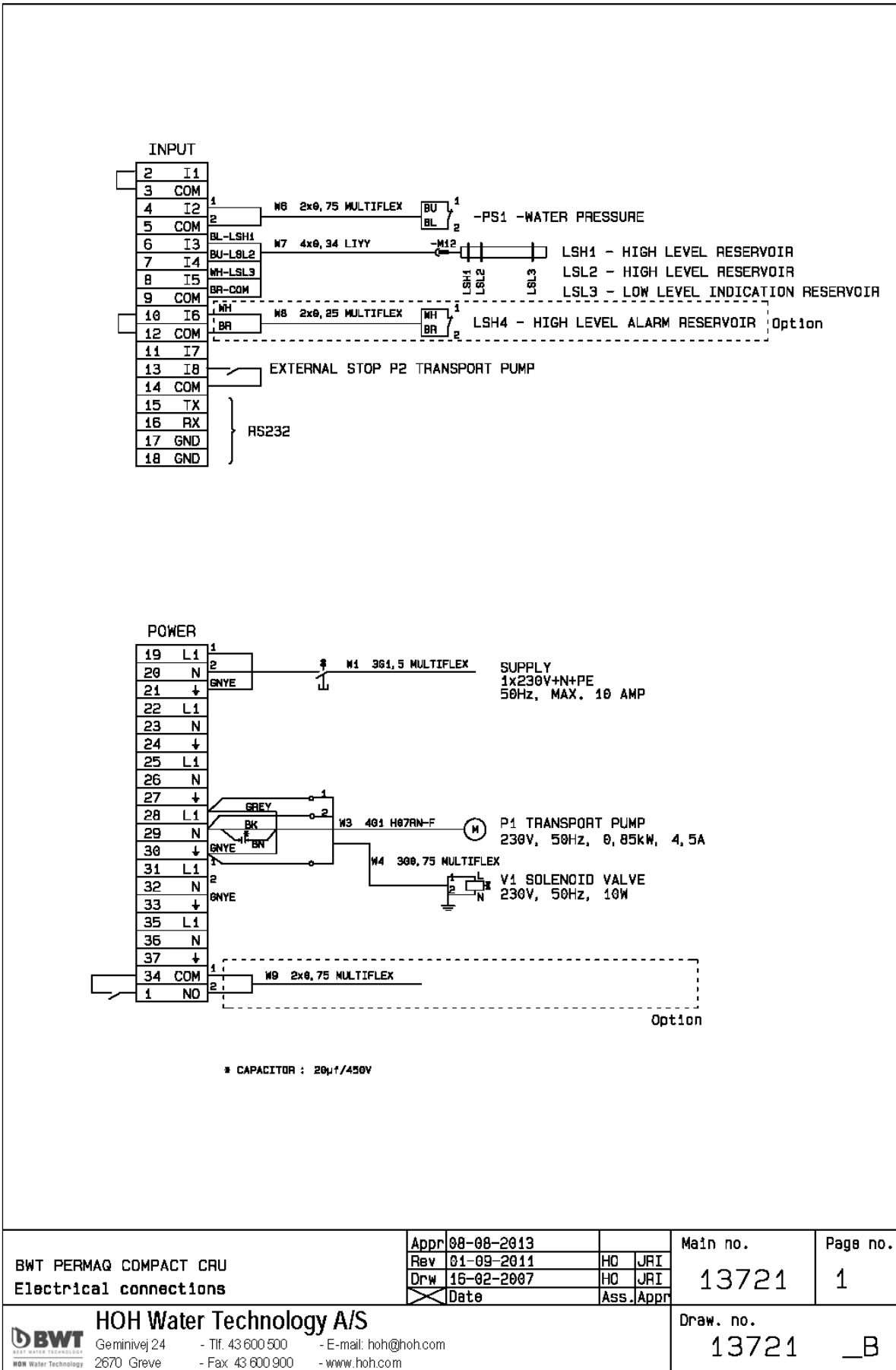

BWT PERMAQ COMPACT CRU
Electrical connections

Appr	08-08-2013		
Rev	01-09-2011	HO	JRI
Drw	16-02-2007	HO	JRI
Date		Ass.Appr	

Main no.	Page no.
13721	1



HOH Water Technology A/S
Geminivej 24 - Tlf. 43 600 500 - E-mail: hoh@hoh.com
2670 Greve - Fax 43 600 900 - www.hoh.com

Draw. no.
13721 _B

9.5. PCB – circuit board

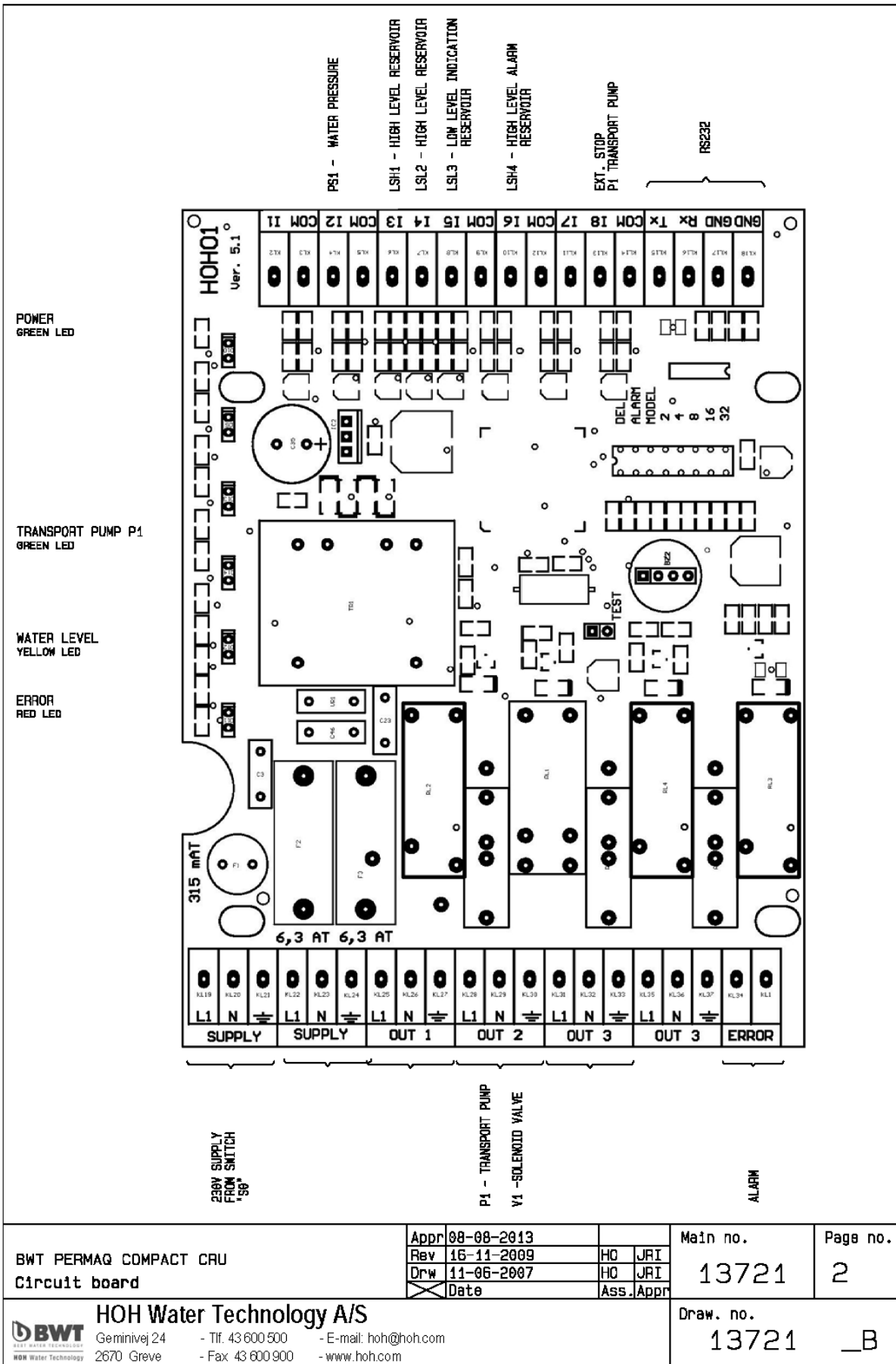

BWT PERMAQ COMPACT CRU Circuit board	Appr	08-08-2013		Main no. 13721	Page no. 2
	Rev	16-11-2009	HC JRI		
	Drw	11-06-2007	HC JRI	Draw. no. 13721	_B
	Date		Ass.Appr		

BWT HOH Water Technology A/S
 Geminivej 24 - Tlf. 43 600 500 - E-mail: hoh@hoh.com
 2670 Greve - Fax 43 600 900 - www.hoh.com

9.6. Start-up test

The start-up test sheet must be completed and filed together with the operating journal.		
Name of customer:	Plant number:	Work-sheet number:
RO plant		
Type of plant:	Permeate flow [l/h]:	Concentrate flow [l/h]:
BWT PERMAQ Compact CRU		
<input type="checkbox"/> Drainage protection, overflow branch is connected to the drain		<input type="checkbox"/> Pressure switch start/stop, transport pump is OK
<input type="checkbox"/> Max. concentrate flow from RO to the CRU is < 500 [l/h]		<input type="checkbox"/> Pre-pressured hydrophore is OK
Status on start-up		
<input type="checkbox"/> Start-up by BWT		<input type="checkbox"/> Start-up by dealer, specify dealer _____
Problems on start-up		
<input type="checkbox"/> YES, there were problems at start-up		<input type="checkbox"/> NO, there were no problems at start-up
<i>In case of problems, please fill in the problem report</i>		
Problem report		
Can the problem be related to the manufacturing?		
<input type="checkbox"/> YES, the problem can be related to the manufacturing		<input type="checkbox"/> NO, the problem cannot be related to the manufacturing
Can the problem be related to the plant or the installation?		
<input type="checkbox"/> YES, the problem only concerns the plant		<input type="checkbox"/> YES, the problem only concerns the installation
<input type="checkbox"/> YES, the problem concerns both the plant and the installation		<input type="checkbox"/> NO, the problem does not concerns the plant or the installation
The plant - we mean only the part of the whole installation which was delivered by BWT (i.e only the plant). The installation - we mean the piping etc. leading to the plant.		
Can the problem be related to the sales department?		
<input type="checkbox"/> YES, the customer was misinformed		<input type="checkbox"/> NO, the customer had been well-informed
Description, please describe the problem		
<hr/> <hr/>		
Signature		
Name/initials of technician:	Date:	Time consumption for the start-up [hours]:

9.7. Spare parts list BWT PERMAQ Compact CRU

Pos. Nr.	BWT PERMAQ Compact CRU	Recommended spare parts	Spare part No.	Recommended replacement frequency
1	100 l tank		451202073	
2	Transport pump		454100070	
3	Hydrophore 0.5 liter	1	451404571	3-5 years
4	Pressure switch	1	451202803	
5	Level switch	1	451404485	5 years
	Cable for level switch	1	451404450	
6	Push-in fitting, 10x½", elbow	1	454091010	
7	½" Non-return valve	1	200729004	
8	Solenoid valve ½"	1	200753004	
9	Control box complete		*	
	PCB		*	
-	20 µF Capacitor (Transport pump motor)	1	750001270	
-	Cable for level switch		451404470	
-	10 mm plastic hose		454001010	3 years

* Contact your local BWT dealer for detailed information.

9.8. Spare parts overview

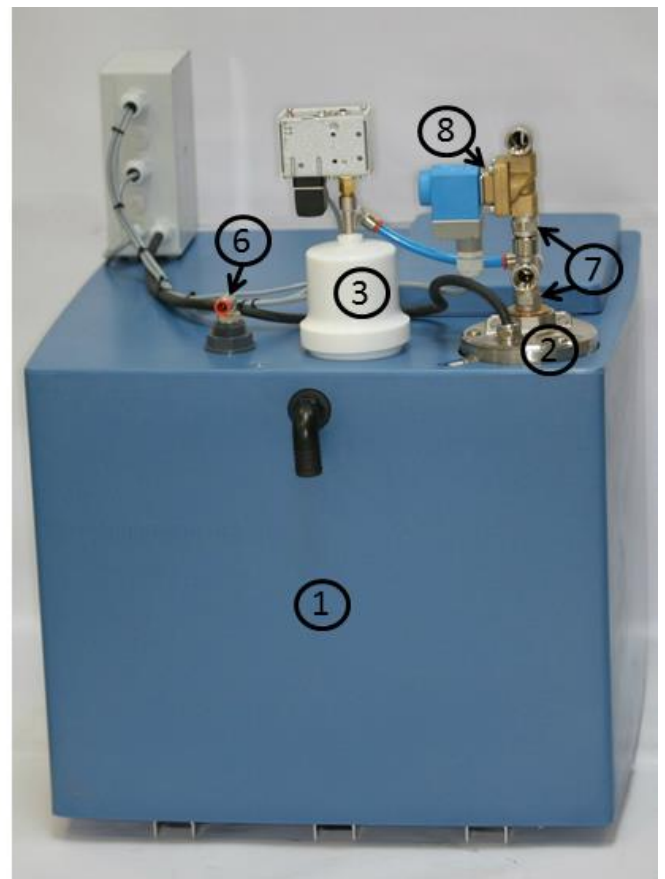

9.9. Disposal

The packaging is to be taken to a local waste disposal site if no longer required. The packaging comprises of environmentally-friendly materials that can be used as secondary raw materials.



The device, including accessories and batteries, is not to be thrown into the household waste. EU legislation in Member States requires electrical and electronic equipment to be collected separately from unsorted municipal waste so that it may be recycled.

In Denmark and several other countries, BWT itself assumes responsibility for the return and conformant disposal of its electronic and electrical products. These products may not be placed with household waste or brought to collection centres run by local public disposal operations – not even by small commercial operators.

For disposal in Denmark and in the other member nations of the European Economic Area (EEA), please contact our local BWT service technicians or our Service Center in Greve, Denmark:

BWT HOH A/S
Geminivej 24
DK-2670 Greve

In countries that are not members of the European Economic Area (EEA) or where no BWT subsidiaries or dealerships are located, please contact your local authorities or a commercial disposal operator.

Remove the batteries and hand them in to a collection point prior to disposal/scraping of the device.

BWT, its affiliates, subsidiaries, dealers and distributors will not take back equipment contaminated with hazardous materials (ABC contamination) – neither for repair nor disposal. Please refer to our web site (www.bwt-group.com) for more detailed information regarding addresses for repair service or disposal of your device.

9.10. Declaration of Conformity

EC DECLARATION OF CONFORMITY FOR MACHINERY

DIRECTIVE 2006/42/EC, ANNEX II, A

LOW VOLTAGE DIRECTIVE

EMC DIRECTIVE



BWT HOH A/S

Geminivej 24 - DK-2670 Greve

tel.: +45 43 600 500 - fax: +45 43 600 900

bwt@bwt.dk - www.bwt.dk

herewith declares that:

BWT PERMAQ Compact CRU

- is in conformity with the provisions of the Machinery Directive (directive 2006/42/EC)
- is in conformity with the provisions of the following other EC directives
- Low Voltage Directive (2006/95/EC)
- EMC Directive (2004/108/EC)

- Place: Greve, Denmark

- Date: 31-07-2013

Lars Jensen
Head of Product Management



For further information, please contact

BWT HOH A/S

Geminivej 24
DK-2670 Greve
Tel : +45 43 600 500
Fax: +45 43 600 900
E-Mail: bwt@bwt.dk

BWT Birger Christensen AS

Røykenveien 142 A
Postboks 136
N-1371 Asker
Tel : +47 67 17 70 00
Fax: +47 67 17 70 01
E-Mail: firmapost@hoh.no

BWT Vattenteknik AB

Box 9226
Kantyxegatan 25
SE-213 76 Malmö
Tel : +46 40 691 45 00
Fax: +46 40 21 20 55
E-Mail: info@vattenteknik.se

BWT Separtec OY

PL 19 Varppeenkatu 28
FIN-21201 Raisio
Tel : +358 2 4367 300
Fax: +358 2 4367 355
E-Mail: hoh@hoh.fi

BWT Austria GmbH

Walter-Simmer-Strabe 4
A-5310 Mondsee
Tel : +43 6232 5011 0
Fax: +43 6232 4058
E-Mail: office@bwt.at

BWT Wassertechnik GmbH

Industriestraße 7
D-69198 Schriesheim
Tel : +49 6203 73 0
Fax: +49 6203 73 102
E-Mail: bwt@bwt.de

Cillichemie Italiana SRL

Via Plinio 59
I-20129 Milano
Tel : +39 02 204 63 43
Fax: +39 02 201 058
E-Mail: info@cillichemie.com

BWT France SAS

103, Rue Charles Michels
F-93206 Saint Denis Cedex
Tel : +33 1 4922 45 00
Fax: +33 1 4922 45 45
E-Mail: bwt@bwt.fr

BWT Belgium NM.

Leuvensesteenweg 633
B-1930 Zaventem
Tel : +32 2 758 03 10
Fax: +32 2 758 03 33
E-Mail: bwt@bwt.be

BWE Česká Republika s.r.o.

Lipovo 196 -Cestlice
CZ-251 01 Říčany
Tel : +42 272 680 300
Fax: +42 272 680 299
E-Mail: info@bwt.cz

BWT Polska Sp. z o.o.

ul. Polczyhska 116
PL-01-304 Warszawa
Tel : +48 22 6652 609
Fax: +48 22 6649 612
E-Mail: bwt@bwt.pl

BWT Hungária Kft.

Keleti út. 7.
H-2040 Budaörs
Tel : +36 23 430 480
Fax: +36 23 430 482
E-Mail: bwt@bwt.hu

BWT UK Ltd.

Coronation Road, BWT House
High Wycombe
Buckinghamshire, HP12, 3SU
Tel : +44 1494 838 100
Fax: +44 1494 838 101
E-Mail: info@bwt-uk.co.uk

BWT Nederland B.V.

Centraal Magazijn
Energieweg 9
NI-2382 NA Zoeterwoude
Tel : +31 88 750 90 00
Fax: +31 88 750 90 90
E-Mail: sales@bwt nederland.nl

BWT AQUA AG

Hauptstraße 192
CH-4147 Aesch
Tel : +41 61 755 88 99
Fax: +41 61 755 88 90
E-Mail: info@bwt-agua.ch

OOO Russia BWT

Ul. Kasatkina 3A
RU-129301 Moscow
Tel : +7 495 686 6264
Fax: +7 495 686 7465
E-Mail: info@bwt.ru

Cillit S.A.

C/Silici, 71 -73
Poligono Industrial del Este
E-08940 Cornelia de Llobregat
Tel : +34 93 440 494
Fax: +34 93 4744 730
E-Mail: cillit@cillit.com