

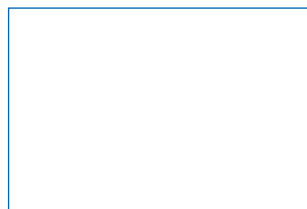

BWT Perla

1-510486 / 12895 / 2019-09 / © BWT Wassertechnik GmbH / Printed in Germany

Changes reserved!



For You and Planet Blue.



Thank you very much for the confidence that you have shown in us by purchasing a BWT appliance.



Table of Contents

1	Safety instructions	4	8	Operation	24
1.1	General safety instructions	4	8.1	Opening the Easy Fill technology cover	24
1.2	Scope of the documentation	4	8.2	Closing the Easy Fill technology cover	24
1.3	Personnel qualifications	4	8.3	Device status display	24
1.4	Transport and installation	5	8.4	Operating display (home screen)	25
1.5	Symbols used	5	8.5	Refilling the regenerative	25
1.6	How safety instructions are displayed	6	8.6	Stoppages and reactivating the unit	34
1.7	Product-specific safety instructions	6	9	Additional online functions	35
1.8	Important notes on the product	7	9.1	Registration without a GSM connection	37
1.9	Definitions	7	9.2	LAN connection	37
2	List of supplied parts	9	9.3	Wi-Fi connection	38
3	Intended use	11	9.4	Activating your BWT product	38
3.1	Proper use	11	9.5	BWT Best Water Home App	39
3.2	Foreseeable misuse	11	9.6	Remote operation	40
3.3	Other applicable documentation	11	9.7	Fault during start-up	41
4	Function	11	9.8	Fault during operation	44
4.1	General	11	10	Operator responsibilities	45
4.2	Operation	11	10.1	Intended operation	45
4.3	Regeneration	12	10.2	Checks	45
4.4	Regenerative monitoring	12	10.3	Inspection	46
4.5	Multi-info touch display	12	10.4	Maintenance in accordance with EN 806-5	47
4.6	Stagnation management	12	10.5	Replacement of parts	47
4.7	Display of flow rates	12	11	Warranty	47
4.8	Display of current flow rate	12	11.1	Product returns	47
4.9	Interaction	13	12	Technical data	48
4.10	Connectivity	13	12.1	Dimensions	49
4.11	Safety	13	12.2	Diagram of peak flow	50
5	Installation conditions	14	13	Troubleshooting	51
5.1	General	14	13.1	Malfunctions	51
5.2	Installation site and environment	14	14	Decommissioning and Disposal	52
5.3	Inflow water	15	14.1	Shutting down the unit	52
5.4	Functional and warranty conditions	15	14.2	Disposal	52
5.5	Installation	15	15	Standards and legal provisions	52
6	Installation	16	16	Operating report	53
6.1	Installation diagram	16	17	German Drinking Water Ordinance notice	54
6.2	Electrical connections	17	18	EU Declaration of Conformity	55
7	Start-up	18			
7.1	Display and operation	18			
7.2	Starting up	18			

1 Safety instructions

1.1 General safety instructions

This product was manufactured according to all recognised regulations and technical standards and complied with the applicable legal requirements when it was put into circulation.

Nevertheless, it can pose a risk of personal injury or property damage if you do not observe this chapter and the safety instructions throughout this documentation.

- Read this documentation carefully and in its entirety before working with the product.
- This documentation must be kept accessible to all users at all times.
- Always hand over the product to third parties together with the full documentation.
- Follow all of the instructions in relation to the proper handling of the product.
- If you detect damage to the product or the mains supply, stop its operation and notify a service technician immediately.
- Use only accessories, spare parts and consumable materials that have been approved by BWT.
- Adhere to the environmental and operating conditions specified in the “Technical data” chapter.
- Use your personal protective equipment. It ensures your safety and protects you from injury.
- Perform only tasks that are described in these operating instructions or that you have been trained to do by BWT.
- Perform all tasks in compliance with all applicable standards and provisions.
- Instruct the operator in the function and operation of the product.
- Instruct the operator in the maintenance of the product.
- Instruct the operator in relation to potential dangers that may arise while operating the product.

1.2 Scope of the documentation

This documentation applies exclusively to the product the production number of which listed in chapter 12, “Technical data”.

This documentation is intended for operators, installers without training from BWT, installers with training from BWT (e.g. drinking water specialists), and BWT service technicians.

This documentation contains important information for fitting the product safely and properly, starting up, operating, using, maintaining, and disassembling the product, and for correcting simple faults independently.

Read this documentation in full before working with the product. Pay particular attention to the chapter “Safety Instructions”.

1.3 Personnel qualifications

The installation work described in these instructions requires basic knowledge of mechanics, hydraulics and electrical systems as well as knowledge of the corresponding specialist terms.

To ensure that the device is installed safely, this work must be performed only by a qualified specialist or a trained person under the guidance of a qualified specialist.

A **qualified specialist** is someone with specialist training, knowledge and experience as well as knowledge of the applicable regulations allowing them to assess the work assigned to them, identify potential risks, and take suitable safety measures. A qualified specialist must comply with the applicable specialist regulations.

A **trained person** is someone who has been instructed by a qualified specialist in the tasks entrusted to them and the potential dangers of improper conduct and, if necessary, trained and instructed on the necessary protective equipment and protective measures.

1.4 Transport and installation







To avoid damage during transport to the installation location, do not remove the BWT product from the packaging until you have reached the relevant location. Then dispose of the packaging in the correct manner. Check that the delivery is complete.

If there is a risk of frost, drain all components that convey water.

Only lift or transport the product or product parts at the eyebolts or attachment points provided.

The product must be placed on a horizontal surface that is sufficiently flat and has a sufficient load-bearing capacity. It must be secured so that it does not fall or tip over.



1.5 Symbols used

	This symbol indicates general risks to persons, equipment or the environment.
	This symbol indicates risks due to the mains voltage. Risk of death by electric shock!
	This symbol indicates information or instructions that you must observe in order to ensure safe operation.
	Unplug device before any service and repair work.
	This symbol indicates information that is important to observe.
	This symbol indicates that at the end of its service life the electrical or electronic device may not be disposed of in household waste.
	This symbol indicates that the product can be recycled after it is shut down.

1.6 How safety instructions are displayed

In this document safety instructions precede any sequence of actions that could cause harm to persons or damage to property. All hazard prevention measures must be followed.



Safety instructions are displayed as follows:

 SIGNAL WORD!	
	<p>Source of hazard (e.g. electric shock)</p> <p><i>Type of hazard (e.g. risk of fatal injury)!</i></p> <ul style="list-style-type: none"> ▶ Escape or prevent hazard ▶ Rescue measure (optional)

Signal word / colour	Indicates the severity of the hazard
Warning symbol	Calls attention to the hazard
Source / type of hazard	Indicates the type and the source of the hazard
Consequences of hazard	Explains the consequences of not following the safety instructions
Hazard prevention measure	Explains how to avoid the hazard

Signal word	Colour	Severity of the hazard
DANGER		High-risk hazard. Indicates a hazardous situation which, if not avoided, will result in death or serious injury.
WARNING		Hazard with a moderate degree of risk. Indicates a hazardous situation which, if not avoided, could result in death or serious injury.
CAUTION		Low-risk hazard. Indicates a hazardous situation which, if not avoided, may result in minor or moderate injury.

1.7 Product-specific safety instructions

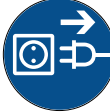
 DANGER!	
	<p>Mains voltage!</p> <p><i>Risk of death by electric shock!</i></p> <ul style="list-style-type: none"> ▶ Unplug device before any service and repair work. ▶ If the mains cable of the unit becomes damaged, you must replace it with an original BWT cable.
	

In the following chapters, you will find product-specific safety instructions whenever you must perform certain safety-related actions on the device.

1.8 Important notes on the product



The product must be installed as described in the installation guide in compliance with the general requirements for the supply of water in Germany ["AVB Wasser"] V, section 12.2 by a water supply company or by a party registered in the water supply company's index of fitters.

In accordance with TrinkwV (German Drinking Water Ordinance) section 16 and section 21, notify residents of the installation of the product, and explain how it works and which regenerative is used.

Using treated drinking water with plants and aquatic animals

Each species of plant and aquatic animal requires water that contains a special combination of substances. Users of the unit should therefore consult the standard literature and check that they can use retreated drinking water for watering plants or for filling ornamental lakes, aquariums or fish ponds.

Handing over the product to the operator



If there is a delay between installation / start-up of the unit and transfer to the operator, both exchanger columns must be manually regenerated.

The operator must be told how the product works as well as how to operate and maintain it.

Hand over the quickguide with instructions on installing and operating the product to the operator.

1.9 Definitions

Inflow water: Drinking water quality of the local water supplier. Depends on the region and described using the degrees of hardness soft, medium or hard.

Softened water: Softened water, usually with water hardness of 0 – 9°dH

Outlet water: The water leaving the softening unit

Luxury water: BWT recommended water quality with water hardness of 4 – 6°dH

Blended water: The BWT softening unit mixes (blends) completely softened water with inflow water to the desired outlet water quality.

Fully softened water: Water with which no inflow water is mixed and which is treated by the device. Hardness value of 0.1 – 2.5°dH.

Microbiological and sensory quality of the (partially) softened water

The quality of the treated water depends greatly on the conditions under which the product is installed and operated. The most important factors are listed in the following table.

	Unfavourable conditions	BWT recommendations
Quality of the inflow water	Unsuitable and marginal quality inflow water may not be altered by the product	Contact the BWT drinking water specialist or fitter
Operating conditions	Long periods of stagnation, infrequent regeneration and incorrect configuration of the system can adversely affect the quality of the luxury water	Observe the notes in the installation and operating manual, contact the BWT drinking water specialist or fitter
Quality of the regenerative	Impurities from cheaper regeneratives with insoluble components cause deposits	Use of BWT Perla tabs or regeneratives that comply with DIN EN 973 type A
Installation situation and conditions	Temperatures in the installation room greater than 25°C, evaporation of solvents or an improper waste water connection may adversely affect the quality of the luxury water	Observe the notes in the installation and operating manual

When determining whether there is a problem with the sensory or microbiological quality of the treated water, it is important where in the system the quality is measured. For example, if the quality is measured at the tap, the water quality may be affected by the pipe material or by the presence of a water heater or hot water storage tank.

2 List of supplied parts

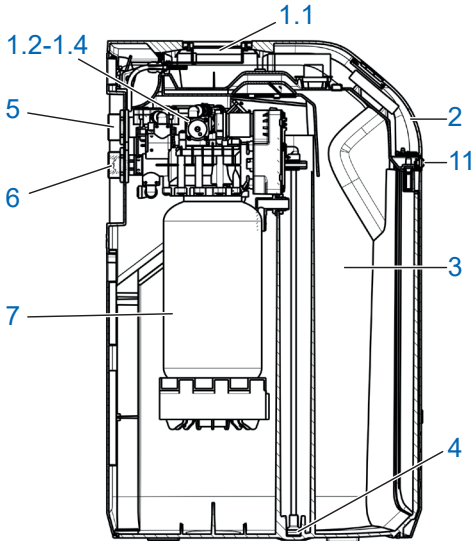

BWT Perla duplex water softener with:



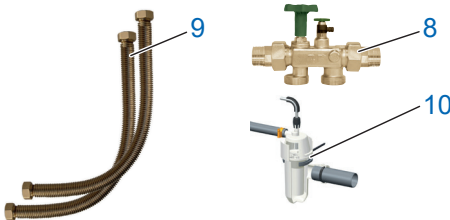

1	1.1 Microprocessor control with 5-inch multi-info touch display
	1.2 Two multiple-way control valves
	1.3 Water meter for partially softened water
	1.4 Blending valve with actuator
2	Easy Fill technology cover
3	Integrated regenerative container
4	Brine suction system
5	Water outlet
6	Water inlet with non-return valve
7	Columns containing ion exchanger material
11	Proximity sensor
–	2 m rinsing water hose
–	2 m overflow hose, 18 x 24
–	Fasteners
–	Floor sensor for detecting a film of moisture (not shown)
–	BWT AQA test hardness monitoring device
–	BWT luxury water test strips for monitoring the quality of luxury water



8	Multiblock module X DN32
9	Connection set, DN 32/32 DVGW
10	BWT siphon

Optional extras (not on list of supplied parts)		Order no.
	BWT Bewasol brine lifting system	11808
	BWT AQA Stop wireless humidity sensor (required accessories for the AQA Guard function)	11772
	LTE antenna, cable length of 3 m	1-444528
	Fault signal cable ZLT	1-433090

Mineral metering units (not on list of supplied parts)		Order no.
	BWT Bewados Plus E3	17080 Austria: 082026
	BWT Bewados Plus E20	17081 Austria: 082027

3 Intended use

3.1 Proper use

This product is intended for the partial softening of drinking and service water. It is also designed to prevent malfunction and damage caused by calcification in water pipes and the connected fittings, devices, boilers and other equipment.

The performance specifications of the product must match the expected usage conditions. For notes on this, see the DIN 1988-200 standard as well as the technical data in chapter 12 of this installation and operating manual.

If the product is intended for a commercial application, a BWT consultant must conduct a test and issue an approval.

Operation of the product with regular function checks and the execution of the maintenance measures required for the safe operating condition of the product in accordance with the operating conditions for planning and construction.

3.2 Foreseeable misuse

A product not used for a longer period of time (7 days in accordance with DIN EN 806-5) is not operated as intended.

Non-compliance with the ambient and operating conditions in the technical specifications in chapter 12.

Failure to comply with the maintenance and service intervals specified in this manual.

The use of unauthorised consumables and spare parts.

3.3 Other applicable documentation

- Data protection notice
- Material safety data sheets
- Installation and operating manual for the installation accessories

4 Function

4.1 General

The BWT Perla is a duplex water softener that functions using ion exchange. The product is filled with organic ion exchange material.

Softened water is made available during a regeneration process.

Regeneration is triggered volumetrically (depending on the quantity of water). This means that no remaining supply of softened water is discarded during regeneration.

4.2 Operation

The mode of operation is consumption-dependent.

Water flows through the columns containing the ion exchange material on an adaptive, parallel basis.

This adaptive, parallel design maximises softened water availability and minimises stagnation in the columns.

In adaptive, parallel flow, water always flows through the columns in parallel except during regeneration.

During regeneration, one column is responsible for softening all the water.

The regeneration time therefore occurs at night, as water consumption is usually lower during this period.

If the capacity falls below 50% before the query time, proportional regeneration starts immediately.

If the capacity does not fall below 50% until after the query time, the control system assumes that the remaining capacity is sufficient to last until the regeneration time.

Regeneration begins immediately if the capacity is exhausted; otherwise it starts at the regeneration time.

4.3 Regeneration

Exchange of hardness forming substances Ca and Mg ions for Na ions from the regenerative at the ion exchanger.

A precision brine meter measures out the brine required.

The product is equipped with a device that disinfects the ion exchange material during regeneration.

By measuring data acquisition during brine extraction, the regeneration process is adapted to the respective pressure conditions, the regenerative and regeneration water consumption is reduced to the required minimum.

The optimised brine preparation process produces as much brine as needed for regeneration in less than 0.5 hours.

The brine collects in a special sink of the regenerative container and is fully extracted from there. After brine extraction, there is no liquid left in the regenerative container.

An ultrasound sensor in the Easy Fill technology cover measures the regenerative level.

The regeneration is proportional. 100% regeneration takes place after 72 hours at the latest for hygiene purposes.

4.4 Regenerative monitoring

100% in the multi-info touch display corresponds to a regenerative filling level of approx. 46 cm.

From a level of about 20%, the device status indicator changes from "blue" to "yellow" to signal a need to refill the regenerative.

4.5 Multi-info touch display

A fully graphical, 5-inch full cap touch display is used for display and for controlling the product. The device status is displayed via the BWT logo.

During start-up, the proposed inflow water hardness of the HYDROMAPS database can be adopted or the hardness of the local drinking water and the desired outlet water hardness can be entered into the control unit.

All other product parameters are stored in the control unit. All product data is pre-set and product parameters can be queried.

The product capacity is displayed as a flow volume in l/h during operation.

Operating data, such as water and regenerative consumption, can be displayed on screen.

The following country-specific settings are available: DE, AT, CH, EN, FR, IT, ES.

Water hardness in: °dH, °f, mol/m³, ppm calcium carbonate.

A memory function for filter backwashing or a filter change can be programmed in the control unit.

4.6 Stagnation management

Depending on the capacity consumption, the product performs a proportional regeneration or a hygiene rinse at the time of regeneration.

If the capacity is not used up within 72 hours, the control unit triggers a regeneration.

4.7 Display of flow rates

(volumes)

The accumulated water consumption indicates the consumption of fully softened water.

4.8 Display of current flow rate

(volume flow)

NOTE



- ▶ The flow shown in the display indicates the outlet water (fully softened water plus added inflow water).
- ▶ A comparison of the displayed volumes using a domestic water meter is not possible.

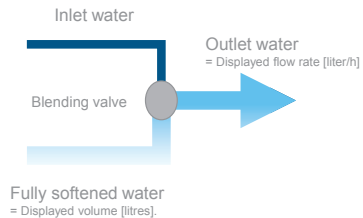

4.9 Interaction

A BWT mineral metering unit can be plugged into the unit at any time.

Up to 10 BWT wireless humidity sensors (order no. 11772) can be taught.

4.10 Connectivity

BWT DES (BWT Digital Eco System)

- Wi-Fi/LAN (LAN via RJ45 socket), can be used after registration with BWT and creation of a customer account.
- ENOCEAN® (optional).
- GSM connection to the BWT server for full functionality and database updates.
- APP: BWT Best Water Home (can be used after registration with BWT and creation of a customer account)
- Plug connection to central instrumentation and control (CIC): The contact opens in the event of an error or power failure (max. contact assignment DC 24 V, 0.5 A)

4.11 Safety

AQA Safe valve

The AQA Safe valve closes the waste water valve in the event of a power failure and thus protects against water damage caused by rinsing water, especially when the rinsing water is being drained by a pump that stops functioning when the power fails.

In the event of a power failure, the control valves remain in their respective operating condition. The programmed parameters are stored permanently and remain unaffected by this.

AQA Watch function

Very small volume flows (< 60 l/h) over a longer period of time (> 10 minutes) indicate a problem in the pipeline network (e.g. leakage, dripping drain tap or leaky toilet cistern). The programmable AQA Watch function of the intelligent control unit monitors the water supply to the building and issues a warning message.

AQA Stop – moisture on floor

If the product's floor sensor detects water on the floor, the water supply in the direction of flow from the unit is shut off and a warning issued. The floor sensor only responds to drinking water (minimum conductivity of 200 $\mu\text{S/cm}$).

AQA Stop – water quantity limitation

To minimise water damage, the control valve shuts off the flow of water downstream of the product following continuous flow of a pre-set water volume.

If larger quantities of water are to be drawn without interruption (e.g. to fill a large whirlpool, swimming pool etc.), this function may need to be deactivated or acknowledged after activation. The maximum continuous flow must be observed.

AQA Guard (optional)

Each BWT Perla device has a floor sensor that monitors the floor for moisture in the immediate vicinity of the unit.

In addition, a further 10 sensors can be wirelessly registered to the BWT Perla. When a sensor detects moisture, the control unit gives a visual warning signal and shuts off the water supply to the building. When using the BWT Best Water Home App on a mobile device, the warning is also displayed there.

5 Installation conditions

5.1 General

The product must be installed as described in the installation guide in compliance with the general requirements for the supply of water in Germany ["AVB Wasser"] V, section 12.2 by a water supply company or by a party registered in the water supply company's index of fitters.

Observe all applicable local installation regulations, general guidelines, sanitary requirements and technical specifications.

5.2 Installation site and environment

Softening units may not be installed in systems that provide water for fire extinguishing purposes.

The installation site must be kept free of frost, must protect the product from chemicals, paint, solvents and fumes, must be structurally waterproofed in accordance with DIN 18195-5 and must allow for easy connection to the water supply system.

NOTE



▶ A connection to the sewage system, a floor drain and a separate mains connection (230 V / 50 Hz) must be located in the immediate vicinity.

If there is no floor drain, the AQA Stop safety function integrated into the softening unit (available with some models) or the internal AQA Stop function may suffice.

However, this is at the property insurer's discretion. It is the unit operator's responsibility to clarify this.

If there is no floor drain and the softening unit does not have an integrated AQA Stop function, a separate safety device will have to be installed on site in the direction of flow upstream of the softening unit.

This safety device (e.g. external BWT AQA Stop) has to shut off the water supply when there is no current in order to prevent unintended water leakage from the softening unit if the product is damaged.

The rated mains power (230 V/50 Hz) and the required operating pressure must be present at all times. A separate means of protection against a shortage of water is not provided and must be installed on site if desired.

If the rinsing water is fed into a pump, it must be designed for a water volume of at least 2 m³/h or 35 l/min for products for building services and at least 3 m³/h or 50 l/min for Rondomat and BWT Perla Professional products.

If the pump is used for other products simultaneously, the size must be adjusted according to their water discharge quantities.

The pump must be resistant to salt water.

In order to benefit from the connectivity of the product, either GSM reception or integration into a home network via LAN or Wi-Fi should be possible at the installation site (see chapter 9).

5.3 Inflow water

The inflow water must always meet the specifications of the Trinkwasserverordnung (German Drinking Water Ordinance) or EU directive 98/83/EC. The total dissolved iron and manganese may not exceed 0.1 mg/l. The inflow water must always be free of air bubbles. Install a bleed device if necessary.

If the treated water is intended for human consumption as defined in the Trinkwasserverordnung (German Drinking Water Ordinance), the ambient temperature must not exceed 25°C.

If the treated water is intended for industrial purposes only, the ambient temperature must not exceed 40°C.

The product's maximum operating pressure must never be exceeded (see chapter 12, Technical data). If the network pressure is higher, a pressure reducer must be installed upstream of the product.

The product requires a minimum operating pressure to function correctly (see chapter 12, Technical data).

The optimal operating pressure is between 3 and 6 bar.

5.4 Functional and warranty conditions

Softening units require regular functional monitoring, maintenance and replacement of important parts after certain intervals.

The amounts of metering substance and regenerative necessary are subject to the level of consumption, which depends on operating conditions.

Softening units must be cleaned regularly and also disinfected if necessary. See this installation and operating manual for the maintenance intervals. We recommend that you enter into a maintenance agreement.

During pressure fluctuations and surges, the sum of the pressure surge and the standing pressure must not exceed the nominal pressure. The positive pressure surge must not exceed 2 bar and the negative pressure surge must not be less than 50% of the self-adjusting flow pressure (see DIN 1988-200/3.4.3).

Continuous operation of the softening unit with water containing chlorine or chlorine dioxide is possible if the concentration of free chlorine/chlorine dioxide does not exceed 0.5 mg/l.

Continuous operation with water containing chlorine or chlorine dioxide can lead to premature ageing if an organic ion exchange material is used. A softening unit can reduce the concentration of free chlorine and chlorine dioxide. In other words, the concentration in the outflow of a softening unit is generally considerably lower than in the inflow.

In order to benefit from the product's connectivity-based features, one of the following must be present at the installation site:

- A GSM signal strength of -40 to -89 dB
- A Wi-Fi signal strength of -20 to -89 dB
- An RJ45 network socket connected to the network within 1.5 m of the device

5.5 Installation

The pipeline network must be rinsed before the product can be installed.

You must check whether a mineral metering device needs to be installed downstream from the product for the purpose of preventing corrosion.

Use corrosion-resistant pipe materials for installation. Pay attention to corrosion-causing chemical properties when different pipe materials are combined (mixed installation), even in the inflow direction upstream of the product.

A protective filter must be installed in the direction of flow 1 m upstream of the product. The filter must be functional before the product is installed. This is the only way to ensure that dirt and corrosive products do not enter the product.

Suitable test sample extraction points must be installed upstream and downstream of the product in accordance with the specifications of VDI 6023.

The hose attached to the overflow point of the regenerative container and the rinsing water hose must be routed at an incline to the sewage system or connected to a pump.

According to EN 1717, the rinsing water hose and the overflow hose must be connected to the sewage system at a specified distance above the highest possible waste water level. (Distance is greater than the diameter of the drain pipe).

6 Installation

6.1 Installation diagram

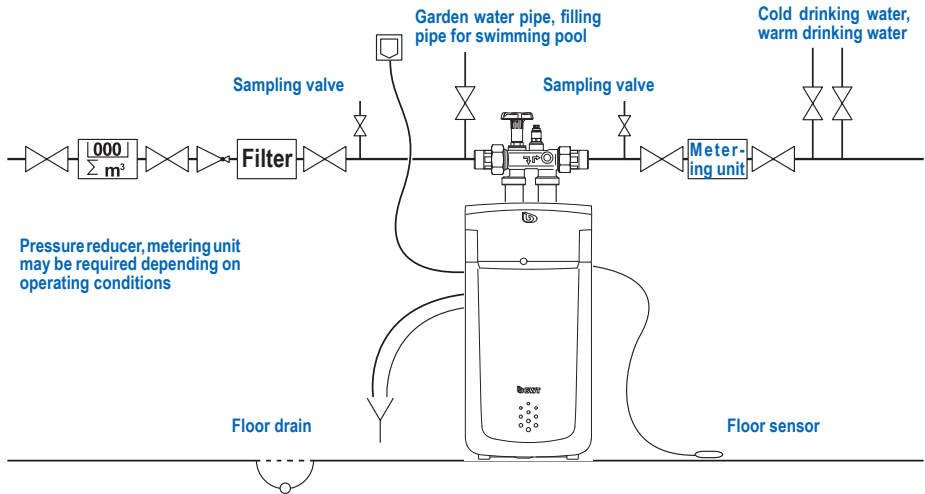

Multiblock X

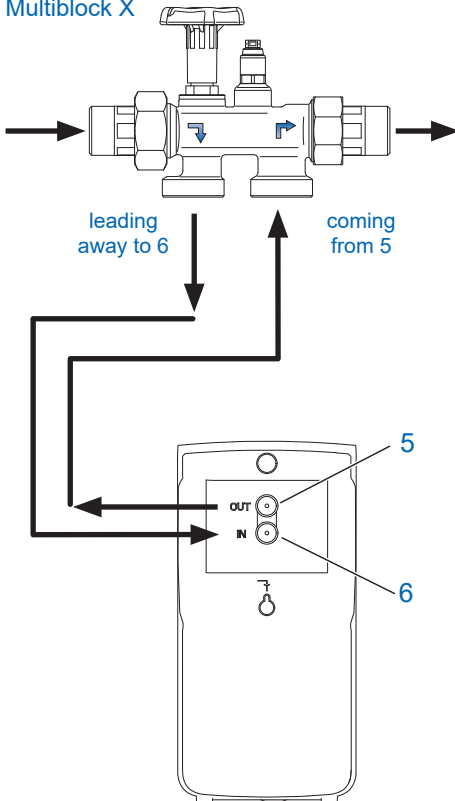

Connect the product as shown in the diagram opposite. A bypass is integrated into Multiblock X. The unit can be installed in horizontal or vertical pipelines.

- Follow the separate installation instructions for the Multiblock X, otherwise warranty claims are void should the unit be damaged.
- Rinse out any dirt particles by opening the handwheel on the Multiblock.
- Connect a corrugated hose to the Multiblock X outlet and then connect this to the inflow water connection **IN (6)** of the product. Observe the arrow indicating the direction of flow!
- Connect a corrugated hose to the Multiblock X inlet and then connect this to the outlet water connection **OUT (5)** of the product. Observe the arrow indicating the direction of flow!

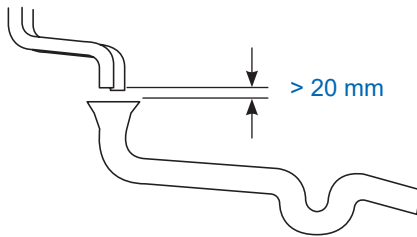
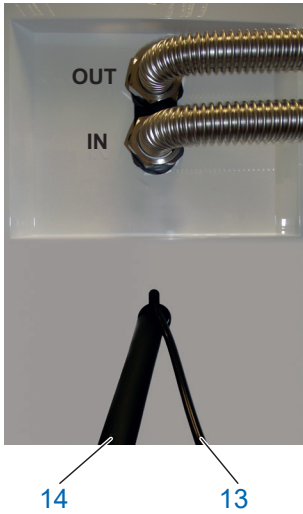

- Lead the rinsing water hose \varnothing 8 mm (13) to the sewage system connection (drain) or connect it to the included BWT siphon and secure the end to prevent it from flapping about when under pressure.
- Lead the overflow hose \varnothing 24 mm (14) to a sewage system connection (drain) at least 10 cm lower or connect it to the included BWT siphon and secure it appropriately.
- The two hoses connected to the sewage system may not be connected or constricted at any point. When using the BWT siphon, connect it to the sewage system connection in accordance with the installation instructions enclosed with the siphon.

In accordance with EN 1717, the rinsing water and overflow hoses must be connected to the sewage system at least 20 mm above the highest possible waste water level (unimpeded drainage).

- Place the floor sensor on the floor.

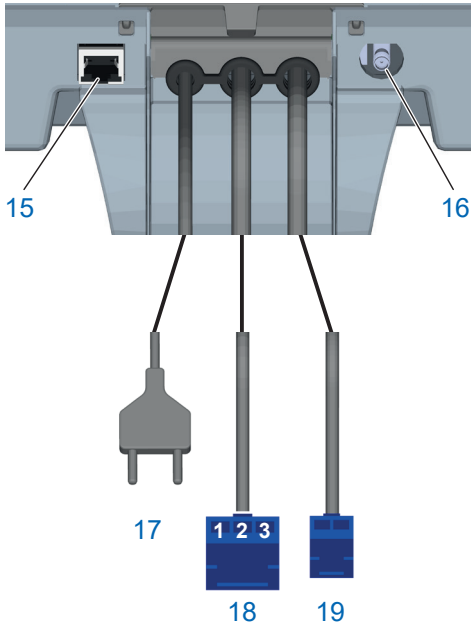

6.2 Electrical connections









The following connections are available at the rear of the Easy Fill technology cover:

15	LAN (RJ45) connection
16	GSM antenna connection (optional, at low signal strength)
17	Mains cable
18	Fault signal contact connection (3 wire), potential-free changeover contact (max. 24 V / 0.5 A) Terminal assignment: Terminal 1-2 closed during operation Terminal 3-2 closed during fault
19	Dosing pump connection (2-wire)

7 Start-up

7.1 Display and operation

Touch display controls

	Menu
	Display of Wi-Fi signal strength
	Display of GSM signal strength
	Next / Next page
	Back / Previous page
	Start page / Status overview
	Server connection active
	Regeneration active

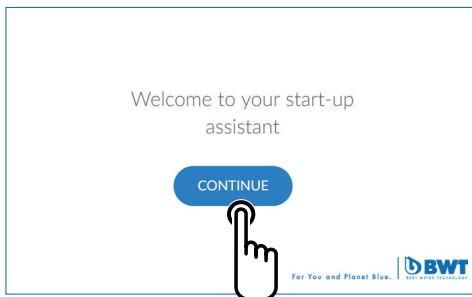
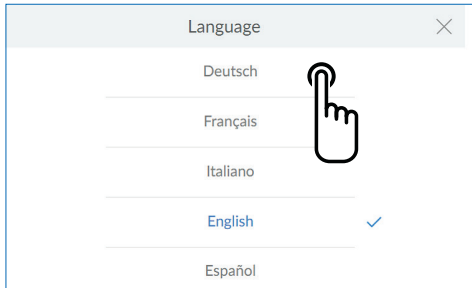

7.2 Starting up

Adding regenerative

Open Easy Fill technology cover (2) and add up to 30 kg of regenerative (regenerative tablets in accordance with DIN EN 973 type A, e.g. Clarosal) to the regenerative container (3).

NOTE



► The product must not be operated with Sanitabs or Sanisal

Inserting the mains plug

The start-up assistant is activated.

Selecting the language

Touch the desired language

Following screen:

Start screen

Start screen

Press **CONTINUE**

Following screen:

Installation check

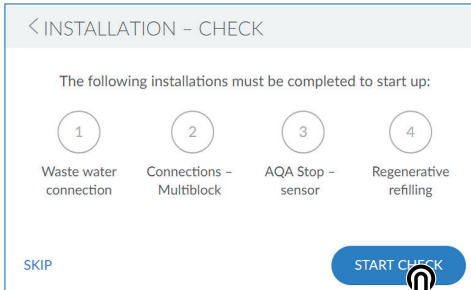

Installation check

The installation check verifies that your product is properly connected.

Press **START CHECK** to begin

Following screen:

Waste water connection in accordance with EN 1717

If you are sure that all the points have been met, you can skip the check.

To do so, press **SKIP**

Following screen:

Registration



Installation check 1/4

Check the waste water hoses are connected properly.

Press **INSTALLED**

Following screen:

Connection on the Multiblock

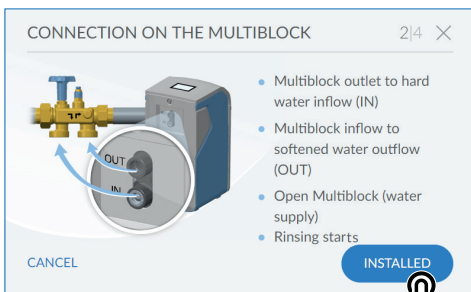

Installation check 2/4

Check the hoses for hard and softened water on the Multiblock are connected properly.

Open the Multiblock by turning the handwheel anti-clockwise until it stops. Rinsing of the device starts.

Press **INSTALLED**

Following screen:

AQA Stop floor sensor



Installation check 3/4

Check the connection and position of the AQA Stop floor sensor.

Press **CONFIRM**

Following screen:

Re-filling the regenerative



Installation check 4/4

Check the level of the regenerative.

Caution: Do not pour water into the device!

Press **CONFIRM**

Following screen:

Installation check

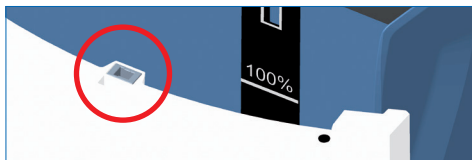

NOTE



► When filling the regenerative, make sure that no dirt gets into the locking mechanism (red circle).

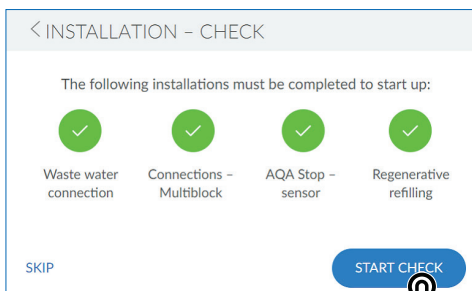

Installation check

The installation check is completed successfully when all four icons are green.

Press **START CHECK**

Device registration begins.

The start-up rinse runs in the background (lasts approx. 6 minutes).

Following screen:

Registration

< REGISTRATION

Register unit Recommendation

You are using all of BWT's services. i >

Without registering
Registration can be performed later under "Settings".
You cannot use BWT services. >

Registration

If you want to register your device now:

At the **top right**, press >

Following screen:

User registration

Registration can be skipped and resumed later.

If you **do not** want to register your device now:

At the **bottom right**, press >

< USER REGISTRATION

E-mail address of system operator

The system operator has acknowledged the data protection statement.
The system operator will receive a copy of the data protection statement at the e-mail address provided. This will complete the agreement process. i

CONTINUE

User registration

Tap inside the text box. A keypad is displayed.

Enter your e-mail address in the text field.

E-mail

test@test.com

q w e r t z u i o p ü
a s d f g h j k l ö ä
↑ y x c v b n m ↵
?123 @ . ✓

NOTE



- ▶ If the registration was unsuccessful, please wait one hour and then try again.
- ▶ To successfully register, complete the steps described in the e-mails you receive.
- ▶ To repeat the registration, this procedure must be repeated in its entirety to connect the device.

Touch the check mark at the bottom right to confirm the e-mail address.

< USER REGISTRATION

E-mail address of system operator

The system operator has acknowledged the data protection statement.
The system operator will receive a copy of the data protection statement at the e-mail address provided. This will complete the agreement process. i

CONTINUE

Select the privacy policy checkbox.

Press **CONTINUE**

Following screen:

Entering the postcode



< ENTER POSTCODE

Country

Postcode

The postcode is required to determine the inflow water hardness.

CONTINUE



Entering the postcode

Entering the postcode will automatically determine the water hardness from the hydromaps database for the installation location of your product.

Tap inside the text box. A keypad is displayed.

Enter the postcode of the installation location of your product.

Press **CONTINUE**

Following screen:

Entering the region

< ENTER POSTCODE

Country

Postcode -

District

CONTINUE



Entering the region

If necessary, select your region in the menu. After making your selection, press **CONTINUE**

< WATER HARDNESS

Determined inflow water hardness (acc. to postcode)

Enter value manually > 22 °dH

Select desired outflow water hardness

Luxury water *i* manual 4 °dH

CONTINUE

Water hardness

The value of the inflow water hardness is entered from a database. Check the database value corresponds to the water hardness at the installation site. If the database value deviates from the measured value, enter the value for the inflow water hardness manually

To change the water hardness, press **ENTER VALUE MANUALLY >**

The desired outlet water hardness can now be selected. It is possible to select the qualities of luxury water (approx. 4 °dH) or to manually set a different outlet water hardness.

After entering the water hardness, the display automatically skips forward!

Following screen:

Rinsing procedure

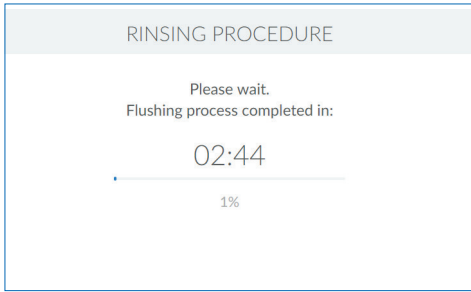

Rinsing procedure

Wait for the end of the rinsing procedure.

Following screen:

Complete the start-up procedure.

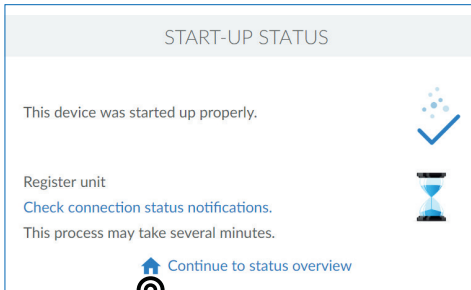

Completing the start-up procedure

The start-up procedure is complete following the rinsing procedure.

Press the **HOME** icon 

Following screen:

Status overview

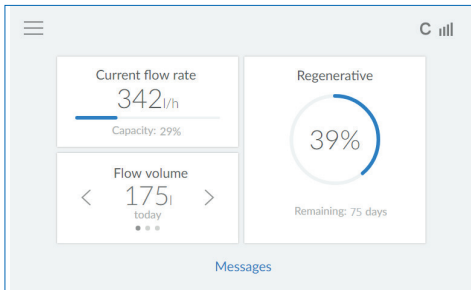

Status overview

Start-up is complete.

The product is ready for use.

After filling, it may take until the next regeneration to update this value.

Range of coverage in days is constantly updated based on your usage behaviour.

NOTE



- ▶ The indicated flow rate refers only to fully softened water. Mixed inflow water and regeneration rinsing water are not detected.
- ▶ The indicated flow refers to the outlet water.

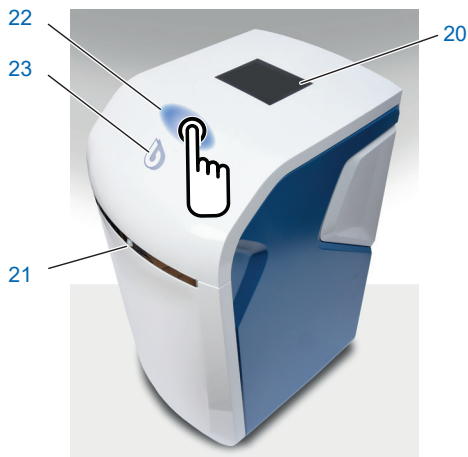

8 Operation

The device status display (BWT logo) and the touch display are in an idle state in energy saving mode and are switched off. When approaching the product, they are activated via a proximity sensor and switched on. The proximity sensor is located in the chrome panel on the front of the device.

20	Touch display
21	Proximity sensor
22	Area for tip-on opening
23	Device status display

8.1 Opening the Easy Fill technology cover

Easy Fill technology cover with handleless tip-on function. To open, tap lightly on the white area of the housing above the status display. The Easy Fill technology cover then opens automatically thanks to a built-in mechanism.

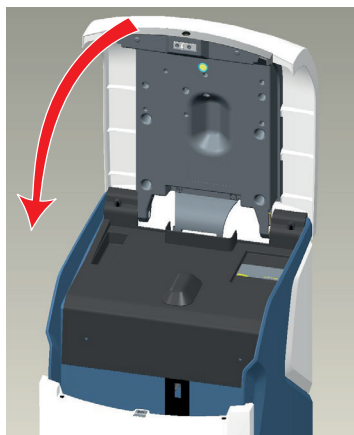



8.2 Closing the Easy Fill technology cover

To close, press the Easy Fill technology cover down gently until it snaps shut.

8.3 Device status display

The device status is indicated by the coloured BWT logo on the device cover.

	Blue	In operation
	Yellow	Important note (e.g. regenerative is empty)
	Red	Fault

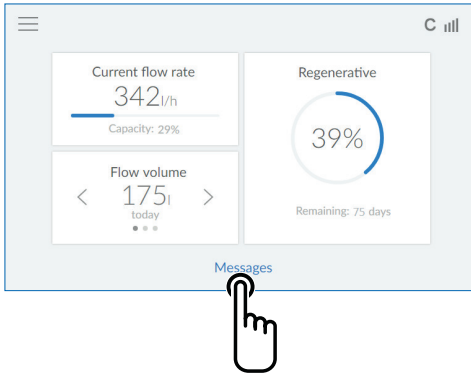

8.4 Operating display (home screen)

Existing softened water flow, regenerative supply and range of coverage.

Outlet water flow rate: Pressing < or > displays the daily, weekly or monthly consumption.

Messages: Pressing MESSAGES displays additional information in chronological order.

Following screen:

Messages

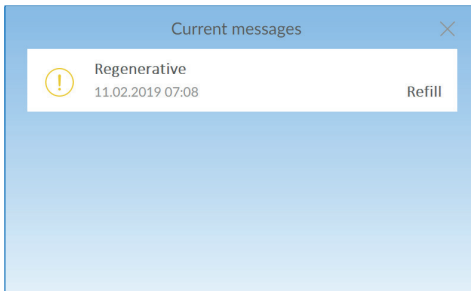

8.5 Refilling the regenerative

The regenerative must be refilled on a regular basis. The product monitors the regenerative supply with a sensor and reports a shortfall via the device status display (yellow) and the display. All commonly available regeneratives that comply with DIN EN 973 type A, (e.g. Perla tabs) can be used.

- Press gently to open the Easy Fill technology cover.
- Fill the regenerative container (R) with regenerative.
- Close the Easy Fill technology cover.

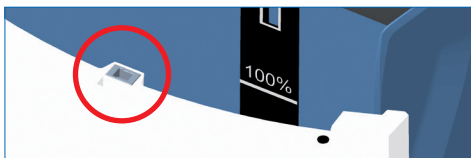
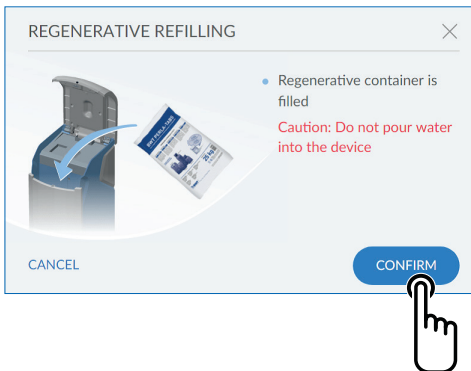

NOTE



- It is important that no dirt gets into the regenerative container when you are refilling (if necessary, clean the regenerative packages before use). Clean the regenerative container with drinking water if dirt does get into the unit.

- Confirm filling using the CONFIRM button in the Messages menu or in the Functions menu under RE-FILL REGENERATIVE.

NOTE



- When filling the regenerative, make sure that no dirt gets into the locking mechanism (red circle).

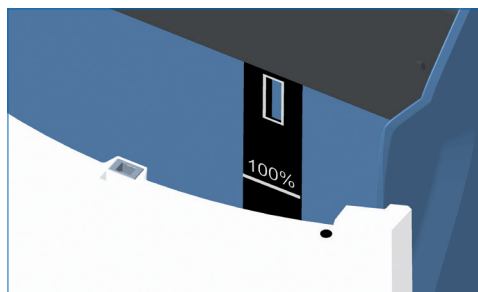

The maximum level of 100% in the multi-info touch display corresponds to a regenerative filling level of approx. 46 cm in the regenerative container.

NOTE



- ▶ Overfilling above the 100% mark can lead to implausible level information. To avoid this, remove the overfilled regenerative in case of overfilling.

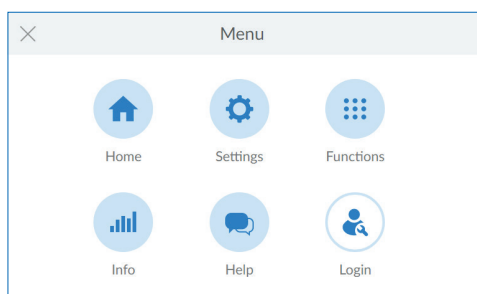

Menu overview

Press **SETTINGS**

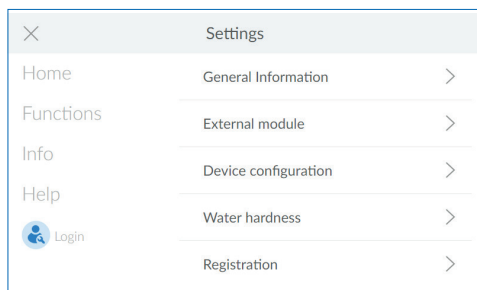

Settings

Press **GENERAL** >

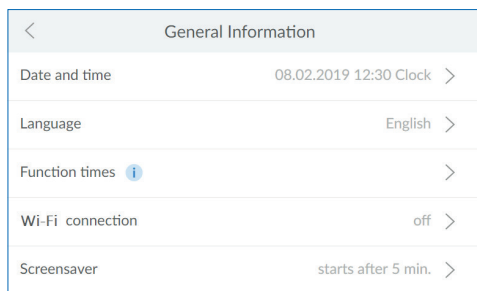

General information

The General menu can be used to set the date, time, language, operating times, Wi-Fi connection and screen saver.

To select a menu item, press the corresponding right arrow >

In order to connect the product to your wireless router, please proceed as follows:

Press **WI-FI CONNECTION** >

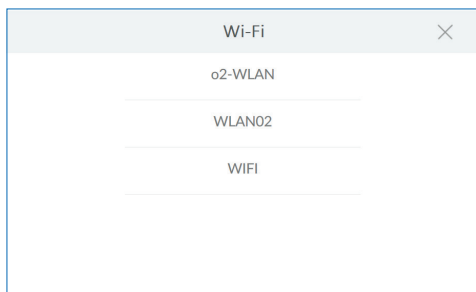

Wi-Fi

The available networks are displayed.

Select the appropriate network and enter the WPA2 key.

Press **CONNECT**

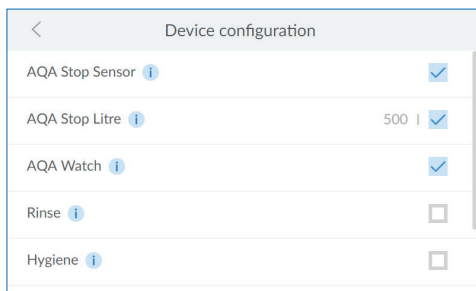

Device settings

The AQA Stop Sensor / Litre, AQA Watch, Rinse, Hygiene and Screensaver functions can be activated or deactivated here.

AQA Stop Sensor

If the product's floor sensor detects water on the floor, the water supply downstream of the product is shut off and a warning issued. The floor sensor only responds to drinking water.

AQA Stop Litre

To minimise water damage, the control valve shuts off the water supply following the continuous flow of a pre-set water volume.

AQA Watch

The programmable AQA Watch function monitors the building's water supply system for consistently low (< 60 l/h) flow rates. (Consistently low flow rates indicate a problem in the pipeline network.) In the event of an error (water flow < 60 l/h for longer than 10 min.), the control unit issues a warning.

AQA Guard / AQA Stop Wireless

When using BWT wireless humidity sensors, they must be connected to the product in the "External modules" menu.

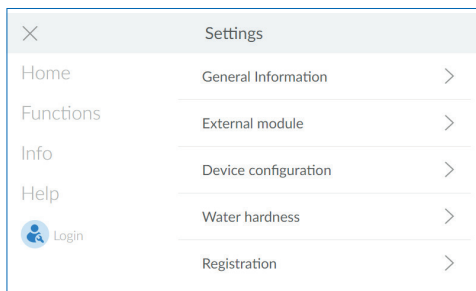

< WATER HARDNESS

Determined inflow water hardness (acc. to postcode) 22 °dH

Enter value manually >

Select desired outflow water hardness

Luxury water *i* manual 4 °dH

CONTINUE

Water hardness

To change the water hardness, press **ENTER VALUE MANUALLY** >

The adjustment of the motor blending of the product should ideally be carried out at a volume flow of 400 to 600 l/h. First of all, measure the hardness of the luxury water at the nearest fully opened tap downstream from the product. Compare this value with the value in the control unit and, if necessary, adjust it, i.e. increase or reduce the hardness.

NOTE



► The water hardness cannot be adjusted during regeneration.

< Set motorized blending

Reduce hardness  Increase hardness

773 *i*

CANCEL
(reset to previous position)

SAVE

Setting actor blending

If the outlet water hardness deviates, it can be finely adjusted in the “Setting blending of motors” screen.

The impulse value within the gear symbol corresponds to a completely open blending. The value below the gear reflects the current position of the blending.

After adjusting your setting, press **SAVE**

×	Functions	
Home	Regeneration/rinsing	>
Settings	Shutting down the unit	>
Info	Refill operating materials	>
Help	Holiday mode	>
 Login	Maintenance	>

Functions

The product must be checked twice a year using the maintenance function.

Press **MAINTENANCE**

Pressing the arrow key will start a step-by-step tutorial.

Routine maintenance ✕

Operator

Specialist

Routine maintenance

According to section 1.3, press **OPERATOR** if you are not a specialist or instructed person.

NOTE



► Maintenance cannot be carried out during regeneration.

< Routine maintenance

1

Check for leaks

2

Measure water hardness

3

Check water inflow

4

Cleaning

START

Routine maintenance

Press **START**

You will be guided through the following steps for maintenance.

CHECK FOR LEAKS 1/5 ✕

CANCEL **CHECKED**

Checking for leaks

In this step, check the system for leaks.

Pay particular attention to water leakage at the screw connections (blue arrows in the picture)

MEASURE WATER HARDNESS 2/5 ✕

In order to take the water sample, a water flow of 400–600 l/h should be set.

Current flow rate
518 l/h

CANCEL **CHECKED**

To determine the water hardness, the water sample should be taken at the nearest sampling point at a volume flow rate of 400-600 l/h.

MEASURE WATER HARDNESS 3/5 X

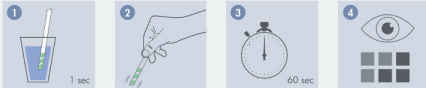

1 1 sec

2 1 sec

3 60 sec

4

Very soft (<math>< 3^{\circ}\text{dH}</math>)
 Luxury water ($4\text{--}6^{\circ}\text{dH}$)
 Soft ($7\text{--}9^{\circ}\text{dH}$)
 Medium-hard or hard ($10\text{--}15^{\circ}\text{dH}$)

CANCEL CHECKED

Checking the water hardness

In this step, check the set outlet water hardness.

Use the enclosed luxury water check and follow the instructions for its use.

CHECK WATER INFLOW 4/5 X

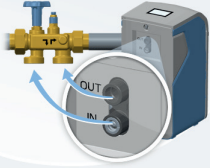

CANCEL CHECKED

Checking the water inflow

In this step, you check whether flow and consumption are correctly recognised by the product.

Allow water to flow at a tap.

CLEANING 5/5 X

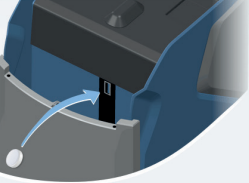

CANCEL PERFORMED

Cleaning

In this step you will carry out the half-yearly cleaning of your product.

Use only BWT IOCLEAN cleaning tablets for cleaning.

Take a cleaning tablet out of the packaging.

Push the cleaning tablet into the designated opening on the product (see adjacent picture).

Press **PERFORMED**

RINSING PROCEDURE

Please wait.
 Flushing process completed in:

50:33

2%

Cleaning

Cleaning begins.

The remaining time until the end of the rinsing procedure is displayed.

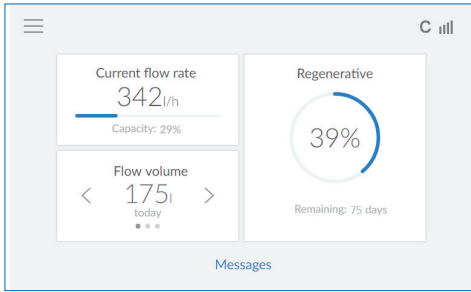

Completing routine maintenance

After completion of the cleaning process, the operating display appears.

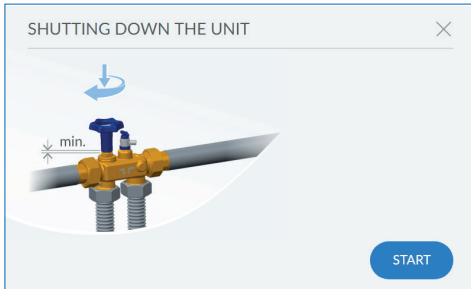

Shutting down the unit

To shut down the unit (e.g. after a long period of absence), press **START**

You will be asked to close the Multiblock. The product is then rinsed without applying pressure.

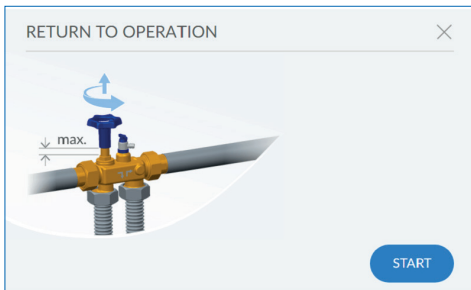

Return to operation

To restart, open the Multiblock first.

Press **START**

The product is deaerated by means of a rinsing procedure.

	Info	
Home	Operating record	>
Settings	Serial no. / PNO	>
Functions	Consumption	>
Help	Connection	>
Login	Device status	>

Info

The Info menu gives you an overview of the operating history and the consumption data.

Data such as product type, device ID, serial number, commissioning date and software versions can be found in the "Device info" menu item.

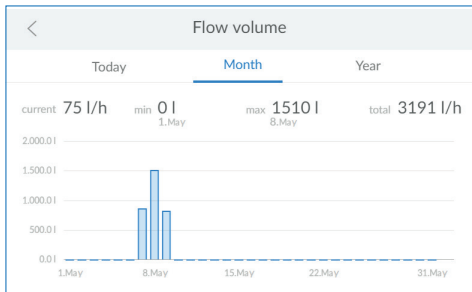

Flow volume

Here you can see a time-related evaluation of the flow rates.

< Serial no. / PNO

Serial number	SCH062018027968/6-500138
Start-up data	09.07.2019 15:32
Product code	U8QJ-G8PV
BWT Connect	1.0804
PCB 1.0	1.7.2

Serial no. / PNO

Here you will find information about your product.

< Serial no. / PNO

PCB 1.1	1.7.2
Unit	BWT Perla
DHCP	<input type="checkbox"/>
IP address	10.1.8.20
Wi-Fi IP address	192.168.110.1

Serial no. / PNO

Here you will find information about your product.

< Device status

Remaining capacity	
Tank 1	255 l
Tank 2	255 l
Start Regeneration	Start
Regeneration step	
Tank 1	Operation
Tank 2	Operation
Regeneration time remaining	
Tank 1	0 s

Device status

Here you will find further information about your product.

Device status	
Tank 2	Operation
Regeneration time remaining	
Tank 1	0 s
Tank 2	0 s
Brine meter – Current suction rate	
	0 ml/s
Brine meter – Amount last extracted	
	0 ml
Flow	
	0 l/h

Device status

Here you will find further information about your product.

Contact person	
Your fitter	
Name	
Telephone	
Your BWT service staff technician	
Name	
Telephone	
SAVE	

Contact person

In the Help menu, you will find contact details of the contact person, e.g. the fitter and after-sales service technician.

BWT support	
Device support	+49 62 03 73 73
Network support	+49 62 03 73 73
Device ID	U8QJ-G8PV

BWT Support

Here you will find the contact information of BWT Support.

Current messages	
	<p>Aqa Stop Sensor 11.02.2019 09:37</p> <p style="text-align: right;">Reset</p>

AQA Stop triggered / releasing the water inflow

The floor sensor is in contact with water or water is flowing continuously and the volume specified has been exceeded. The water supply downstream of the product has been blocked and the status indicator lights up red. Please resolve the issue and dry the floor sensor if necessary.

Press **MESSAGES** in the operating display.

In the AQA Stop Sensor or AQA Stop Litre menu item, press **RESET**

The control valve then releases the water supply and the status display lights up blue.

8.6 Stoppages and reactivating the unit

In case of expected stagnation phases, take the following preventive measures:	BWT recommendations for restarting a unit after stagnation phases:
Fewer than 3 days: None	Start-up rinse of the product. Then open all taps to rinse the system.
3 to 30 days: Close the Multiblock.	Open the main shut-off valve and the Multiblock. Regenerate both exchanger columns. Then open all taps to rinse the system.
1 to 6 months: Close the Multiblock and shut down the product.	Open the main shut-off valve and the Multiblock. Have BWT after-sales service perform a regeneration of both exchanger columns using Dioxal disinfectant. Then open all taps to rinse the system.
Longer than 6 months: Close the Multiblock and shut down the product.	Reconnect the unit to the municipal drinking water system. Have BWT after-sales service perform a regeneration of both exchanger columns using Dioxal disinfectant.

9 Additional online functions

In order to be able to use all additional online functions provided by BWT, a BWT user account must be created with which the product is registered. Among other things, it provides access to the water hardness database, software updates and fault diagnosis functions. You can also integrate the product into a home network and thus manage the consumption data or get up-to-date messages directly to the smartphone using the BWT Best Water Home App.

< USER REGISTRATION

E-mail address of system operator

The system operator has acknowledged the data protection statement.
The system operator will receive a copy of the data protection statement at the e-mail address provided. This will complete the agreement process. 

CONTINUE

E-mail

test@test.com

q w e r t z u i o p ü
a s d f g h j k l ö ä
↑ y x c v b n m ↵
?123 @ . ✓

< USER REGISTRATION

E-mail address of system operator

The system operator has acknowledged the data protection statement.
The system operator will receive a copy of the data protection statement at the e-mail address provided. This will complete the agreement process. 

CONTINUE

User registration

Tap inside the text box. A keypad is displayed.

Enter your e-mail address in the text field.

NOTE



- ▶ If the registration was unsuccessful, please wait one hour and then try again.
- ▶ To successfully register, complete the steps described in the e-mails you receive.
- ▶ To repeat the registration, this procedure must be repeated in its entirety to connect the device.

Touch the check mark at the bottom right to confirm the e-mail address.

Select the privacy policy checkbox.

Press **CONTINUE**

Following screen:
Entering the postcode

< ENTER POSTCODE

Country

Postcode

The postcode is required to determine the inflow water hardness.

CONTINUE



Entering the postcode

Entering the postcode will automatically determine the water hardness from the hydromaps database for the installation location of your product.

Tap inside the text box. A keypad is displayed.

Enter the postcode of the installation location of your BWT Perla.

Press **CONTINUE**

Following screen:

Entering the region

< ENTER POSTCODE

Country

Postcode -

District

CONTINUE



Entering the district

If necessary, select your district in the menu.

After making your selection, press **CONTINUE**

REGISTRATION STARTED



The registration is being sent.
Check connection status notifications.
This process may take several minutes.

 Continue to settings

Registration started

Registration of your BWT product has been initiated. You will receive an e-mail within the next few minutes. To complete the registration, please follow the steps described there.

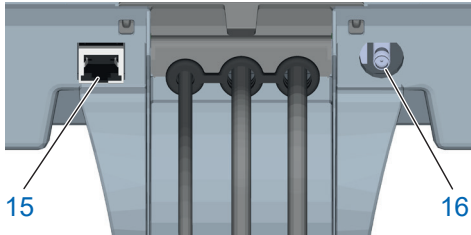
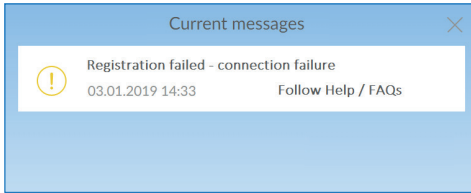

Serial no. / PNO	
PCB 1.1	1. 7. 2
Unit	BWT Perla
DHCP	<input checked="" type="checkbox"/>
IP address	192.168.178.76
Wi-Fi IP address	192.168.110.1

9.1 Registration without a GSM connection

If the registration via the GSM connection fails due to lack of signal strength, this will be indicated by a note in "Messages". In the event that you are unable to complete the registration even after trying again, there are other alternatives for registering your BWT product:

1. Use of an external GSM antenna. This can be obtained from the local fitter or BWT service technician and is connected to the antenna connection (16).
2. Integration of your BWT product into a home network via LAN (RJ45 Ethernet connection (15)) or Wi-Fi.

9.2 LAN connection

LAN connection to the home network via an existing router

Connect the LAN socket (15) of the BWT product to the router of your home network using a network cable (RJ45 Ethernet connection).

In the control panel of your BWT product, select Info / Serial no. / PNR, scroll down and check the DHCP item. The IP address assigned by the router is now displayed in the "IP address" field.

NOTE



- ▶ Integration into a home network is possible using either LAN or Wi-Fi. It is not possible to have two connections at the same time.
- ▶ To enable data transfer, the following port must be open on your router: TLS / SSL port 443

PCB 1.1	1.7.2
Unit	BWT Perla
DHCP	<input type="checkbox"/>
IP address	10.1.8.20
Wi-Fi IP address	192.168.178.83

9.3 Wi-Fi connection

Wi-Fi connection to the home network via an existing router

In the control panel of your BWT product, select Settings / General / Wi-Fi connection and activate the connection.

Select Network under the menu item. You can now select your home network, enter the corresponding security key and connect via Connect.

If the connection is successful, press **CONTINUE**. The IP address assigned by the router is now displayed in the “Wi-Fi IP address” field under Info / Serial no. / PNR.

NOTE



- ▶ Integration into a home network is possible using either LAN or Wi-Fi. It is not possible to have two connections at the same time.
- ▶ To enable data transfer, the following port must be open on your router: TLS / SSL port 443

Your personal BWT-Account

To get access to the individual service features for your BWT products, create a new BWT account or log in with your existing BWT or Google account.

CREATE NEW

You can also use your existing account.

Login with Google

9.4 Activating your BWT product

After registering your BWT product, you will receive an e-mail to confirm the product registration. Your BWT product can be activated once you have filled out the corresponding fields.

Use the user data of your existing BWT customer account or create a new account.

You will then receive confirmation of the registration by e-mail. Please keep this e-mail safe, as the passwords it contains are required for remote operation.

Your BWT product is now registered and you can use all additional online functions.



9.5 BWT Best Water Home App

The BWT Best Water Home App offers a clear overview of your products.

Options of the BWT Best Water Home App

- Monitoring the regenerative level
- Service information
- Holiday mode
- Warning and fault messages
- Direct communication with your BWT drinking water specialist
- Regular newsletters and promotions relating to your BWT products are available on request

NOTE



- ▶ The product data is not displayed in real time.

Installation of the BWT Best Water Home App

Launch the Apple app store or Google Play store on your mobile device and search for “BWT Best Water Home”.

Install the BWT Best Water Home App and then open it.

Select **ADD BWT PERLA** and log in with your BWT user account (e-mail address and password).

NOTE



- ▶ You can only be logged in with one account. Always use the same account to activate all your BWT products.

Your BWT product is now integrated into the BWT Best Water Home App and can be used.

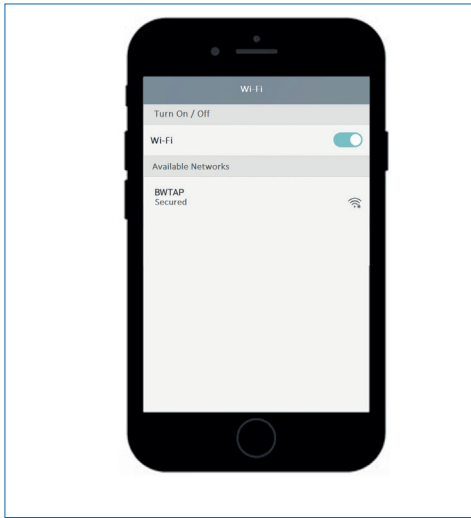

Serial no. / PNO	
PCB 1.1	1. 7. 2
Unit	BWT Perla
DHCP	<input type="checkbox"/>
IP address	10.1.8.20
Wi-Fi IP address	192.168.110.1

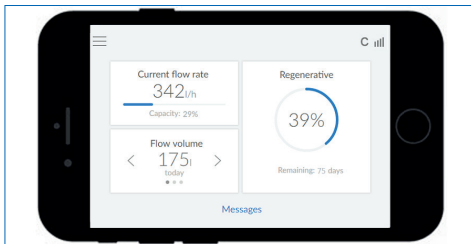

9.6 Remote operation

Remote operation can be used to retrieve the current status of your product. After connecting, the control panel of your BWT product is displayed in the browser.

You can now operate your product remotely.

Wi-Fi direct connection with mobile device (Access point mode)

Select Settings / Wireless and networks / Wi-Fi settings on your mobile device.

The Wi-Fi of the BWT product appears as BWTAP. Select the **CONNECT** option and then enter the Wi-Fi key that you received during product registration.

Open your browser and enter the Wi-Fi IP address (192.168.110.1) displayed under Info / Serial no. / PNR in the address bar.

The login window of the BWT product appears. Enter the login code that you received from BWT by e-mail.

NOTE



- ▶ If a field opens with a security warning, press **NEXT** or **CONTINUE**.
- ▶ Use only the following browsers: Mozilla Firefox (from version 38), Google Chrome (from version 62), Internet Explorer (from version 11), Opera (from version 49) or Safari (from IOS version 9.3.5).
- ▶ The maximum range for this type of connection is around 5 m.
- ▶ The Wi-Fi connection can be used either for integration into the home network or for direct connection to a mobile terminal. It is not possible to have two Wi-Fi connections at the same time.

Your BWT product is now connected to your mobile device via Wi-Fi and can be operated.

Serial no. / PNO	
PCB 1.1	1. 7. 2
Unit	BWT Perla
DHCP	<input checked="" type="checkbox"/>
IP address	192.168.178.76
Wi-Fi IP address	192.168.110.1

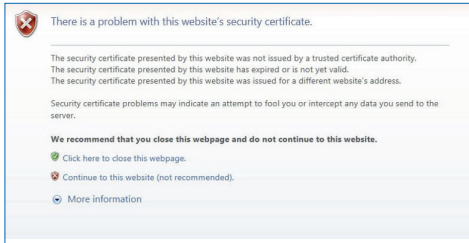

Connection via the home network

If your product is not yet integrated in the home network, follow the steps described in chapter 9.2 (LAN) or 9.3 (Wi-Fi).

Open the browser of a device in the home network (smartphone/tablet/computer) and enter the IP address displayed under Info / Serial no. / PNR in the address bar.

NOTE



- ▶ If a field opens with a security warning, press NEXT or CONTINUE.
- ▶ To enable data transfer, the following port must be open on your router: TLS / SSL port 443
- ▶ Depending on the configuration of your router, the assigned IP address may change daily.

The login window of the BWT product appears. Enter the login code that you received from BWT by e-mail.

Your BWT product is now connected and can be operated.

9.7 Fault during start-up

Fault	Possible source of the fault	Steps to resolve the fault
1 Fault when activating the product	1.1 Were all mandatory fields completed?	Make sure the Title, Surname and E-mail address fields are complete. If all fields are completed correctly, please follow step 1.2.
	1.2 Is the product connected to the Internet?	Check the product's Internet connection using the reception bars on the top right of the display. If no GSM connection is established, please follow the steps to connect the product to the home network (chapter 9.2 and 9.3 (LAN, Wi-Fi)). If a connection is established, please follow step 1.3.
	1.3 Is there a success report in the message overview?	Use the product to navigate to the "Messages" menu and check for the message "Registration successful – check incoming e-mail". If you do not find this message, start the activation process again. If you find the message, please follow step 2.1.
2 Fault when delivering the activation message	2.1 Has sufficient time passed?	Activation of your product may take up to an hour. If after this period you have not received an activation e-mail to the address you have provided, please follow step 2.2.

	2.2 Is the e-mail address correct?	Please check that the e-mail address stored on the product is correct and correct the e-mail address if necessary. If the e-mail address is correct, please follow step 2.3. If an incorrect e-mail address was entered during the initial input stage and you do not receive an activation message, please contact the BWT service hotline (after-sales service).
	2.3 Is the e-mail in a spam folder?	Please check the spam / junk mail folder of the e-mail address provided. If this does not solve the problem, please restart the activation.
	2.4 Have you carried out the activation again?	If you have already carried out the activation again but the problem persists, please contact the BWT service hotline (after-sales service). Please have the serial number and device ID ready. These can be found in the "Info / Serial no. / PNR" menu.
3 Fault during on-line activation	3.1 Website does not open when you click on the activation link	Please check the Internet connection of the product on which you wish to open the link. Online activation can only be performed when the Internet connection is active.
	3.2 Website opens with a service message (maintenance)	Occasionally, maintenance of the systems must be performed. During these periods, activation is not possible. Please try again after the specified maintenance period.
	3.3 Website opens with a fault message (service request not available (any longer))	To guarantee security, activation links have an expiration date. This date was exceeded. Please restart activation on the product.
	3.4 User account creation not possible (maintenance message)	Occasionally, maintenance of the systems must be performed. During these periods, activation is not possible. Please try again after the specified maintenance period.
	3.5 User account creation not possible (fault message – input)	Please check that the entries in the mandatory fields are correct.
	3.6 User login not possible (maintenance message)	Occasionally, maintenance of the systems must be performed. During these periods, activation is not possible. Please try again after the specified maintenance period.
	3.7 User login not possible (fault message)	Please check the e-mail address and password for accuracy. Make sure the Caps Lock key on your keyboard is not activated. Also check the language of the keyboard you are using and make sure that this matches your desired input language.
	3.8 User login not possible (forgotten password)	Click on "Forgotten password" and follow the process to set a new password.
	3.9 It is not possible to complete the activation (input fields incomplete)	Please check the input fields. All mandatory fields must be filled with correct values.

	3.10 Complete the activation (consent to data protection agreement)	Please read the data protection agreement carefully and confirm your agreement. Use of digital services is only possible with consent.
	3.11 Complete activation (fitter not found)	Your installation partner may not yet be a BWT partner. Use of partner services is only possible in collaboration with a BWT partner.
4 Fault after successful start-up	4.1 Product does not yet show in the "Settings/Registration" menu that the registration was successful even though the activation process was successful. (E-mail confirmation of successful activation received)	It can take up to an hour for the product to successfully activate. If this period has already expired, please contact the BWT service hotline (after-sales service).

9.8 Fault during operation

Fault	Possible source of the fault	Steps to resolve the fault
1 Fault when downloading the app	1.1 Link does not work	Please check the Internet connection and the availability of the required app store on your smartphone. Try again. Make sure you have a QR code reader installed on your smartphone.
	1.2 Installation not possible (Android or iOS)	Check the version of your smartphone operating system. This must correspond to a supported version.
	1.3 Installation not possible	Unfortunately, your operating system is not supported.
2 Registration in the app	2.1 Unable to register in the app	Please check the Internet connection of your smartphone. Registration is only possible with an existing Internet connection.
		Check the registration details and, if necessary, reset the password you have chosen.
		Occasionally the servers have to be maintained. In this case, a service message is displaying indicating a time period for the maintenance. Please try again after the time period has expired.
	2.2 Product is not displayed	Did you activate the product successfully? You will receive the e-mail confirming successful activation after completion of the activation process. If this is not the case, please contact the BWT service hotline (after-sales service)
	2.3 Device status and app do not match	Please check the Internet connection of your product and also make sure that your smartphone has a valid Internet connection.
		After activation for the first time or during operation, the status is calibrated just once a day via GSM. As a result, there may be deviations.
		If the deviations persist over a period of several days, please contact the BWT service hotline (after-sales service).
	2.4 You do not have an execution message after triggering an action (holiday mode, rinse, regenerate)	Triggering an action can take up to one hour. If this period has expired, please check the Internet connection of your product and your smartphone. If an Internet connection is available and the period of one hour has expired, please contact the BWT service hotline (after-sales service).
	2.5 Holiday mode cannot be deactivated	For safety reasons, holiday mode can only be deactivated on the product itself. Please use the product.

10 Operator responsibilities

You have purchased a product that is durable and easy to service. However, certain duties must be carried out. Flawless function requires:

- Operation as intended
- Regular checks and servicing

Check the quality and pressure conditions of the inflow water regularly with your water supplier. If the water quality changes, the settings may need to be changed. Consult a specialist in this case.

To ensure the proper functioning and safety of the product, regular inspections must be carried out by the operator (every 2 months), and routine maintenance (EN 806-5) must be performed by the BWT after-sales service staff or a fitter authorised by BWT to carry out maintenance (every 6 months).

Wearing parts must also be replaced after the prescribed intervals in order to guarantee functionality and fulfil the warranty conditions.

10.1 Intended operation

The intended operation of the product includes start-up, operation, decommissioning and, if necessary, recommissioning. Intended operation of the product and drinking water installation requires regular checks, servicing and operation (water flows through the product) in accordance with the operating conditions for design and construction, including simulated sampling (manual or automated rinsing), as appropriate. If simulated sampling is not possible, the product must be taken out of service.

10.2 Checks

(Carried out by the operator)

BWT recommends that the operator regularly carry out the following checks and record the results:

- **Water quality.** Depending on the product, inflow water values and set outlet water values may need to be corrected.
- **Water pressure.** If the pressure conditions change, the product settings may also have to be changed.
- Operating condition of the product.
- Check whether messages have been issued.
- Watertightness.

10.3 Inspection

(Carried out by the operator in accordance with EN 806-5)

Inspection activities	Interval	Note for products WITHOUT active BWT DES registration	Note for products WITH active BWT DES registration
Check/refill regenerative	According to use	Required	Required
Check brine containers for soiling	Every 2 months	Required	Required
Check for leaks, visual inspection	Every 2 months	Required	Required
Functional test/control unit display	Every 2 months	Required	Not required
Test regenerative consumption depending on the treated water	Every 2 months	Required	Not required
Check the setting of the regeneration waste water system	Every 2 months	Required	Required
Check the counting function of the water meter	Every 2 months	Required	Not required
Test the regeneration process	Every 2 months	Required	Not required
Clean the brine container and the internal surfaces that come into contact with water	Every 6 months	Required	Required

10.4 Maintenance in accordance with EN 806-5

(Carried out by BWT after-sales service or an authorised technician in accordance with EN 806-5)

In addition to all inspection activities, maintenance work on the assemblies listed below is required every 6 months by BWT after-sales service or a specialist trained by BWT. A detailed maintenance manual can be requested from the qualified fitter at BWT. We recommend that you enter into a maintenance agreement with the BWT after-sales service department or your fitter.

Assembly (the assemblies exist or do not exist depending on the type and design of a BWT product)	
Cleaning and possible sanitisation	
1.1	Entire hydraulic unit
1.2	End shield
1.3	Gears
1.4	Drive motor
1.5	Spool
1.6	Red/green injector
1.7	Electrolysis cell
1.8	Locking pin
1.9	Waste water elbow
2.0	JG hoses
2.1	Blending
2.2	Water meter cover
2.3	Impeller
2.4	Guide baffle
2.5	Non-return valve
2.6	Bypass valve
2.7	Filler plug
3.1	Brine meter
3.2	Brine meter solenoid valve

5.1	Sieve base
5.2	Low salt gauge
5.3	Brine level switch
6.1	AQA Stop floor sensor
6.2	BWT AQA test

10.5 Replacement of parts

The operator must ensure that parts that are subject to wear and aging during the life of the product are replaced by a qualified fitter.

Details of the replacement cycles can be found in the maintenance manual from BWT.

11 Warranty

If the product malfunctions during the warranty period, please contact your contract partner, the installation company, and indicate the model type and production number (see specifications or the type plate on the unit).

Non-compliance with the installation conditions and the responsibilities of the operator, as well as improper use leads to the loss of warranty and exclusion of liability.

11.1 Product returns

At BWT, product returns will not be processed without a return number (RMA no.). In Germany, call our after-sales service in Schriesheim to receive a return number.

Unauthorised returns of goods will not be accepted by BWT. Please always contact your contract partner first.

You can reach us at the following number:

Service acceptance	06203 / 7373
Monday to Thursday:	6:30 a.m. to 6:00 p.m.
Friday:	6:30 a.m. to 4:00 p.m.

12 Technical data

Softening unit	Type	BWT Perla
Nominal connection width	DN	32
Connection type		G 1¼"
Nominal capacity in accordance with DIN EN 14743 min./max.	mol (m ³ x °dH)	2 x 1.1 (2 x 6.2)
Capacity / kg of regenerative in accordance with DIN EN 14743	mol	4.3
Peak flow with closed blending	m ³ /h	See diagram of peak flow
Peak flow when blending from 20°dH to 0°dH	m ³ /h	1.0
Nominal flow in accordance with DIN EN 14743	m ³ /h	3.2
Nominal pressure PN	bar	10
Min./max. operating pressure	bar	2 to 8
Pressure drop at operating flow	bar	0.2
Area of application according to DIN 1988-200	Residential units People	1 to 5 2 to 12
Ion exchange material fill quantity	l	2 x 3.2
Supply of regenerative, max.	kg	32
Regenerative consumption per 100% regeneration, approx.	kg	0.25
Rinsing water consumption per 100% regeneration at 4 bar, approx.	l	21
Rinsing water flow during regeneration, approx.	l/h	170
Duration of 100% regeneration per ion exchange tank, approx.	min.	21
Water temperature, min./max.	°C	5 to 25
Ambient temperature, min./max.	°C	5 to 40
Humidity		Non-condensing
Power supply	V / Hz	230 / 50 – 60
Unit voltage	VDC	24
Power during operation	W	5.6
Power during regeneration, max.	W	40
Fault message output, max.	VDC / A	24 / 0.5
Protection class		IP54
Operating weight if filled to max.	kg	80
Shipping weight, approx.	kg	36
Production number	PNO	6-500138

12.1 Dimensions

Name			BWT Perla
Height	A	mm	797
Width	B	mm	394
Depth	C	mm	505
Water inlet connection height	D	mm	592
Water outlet connection height	E	mm	652
Overflow connection height	F	mm	410
Clearance to allow the device cover to be opened	G	mm	400
Min. sewage system connection		DN	40

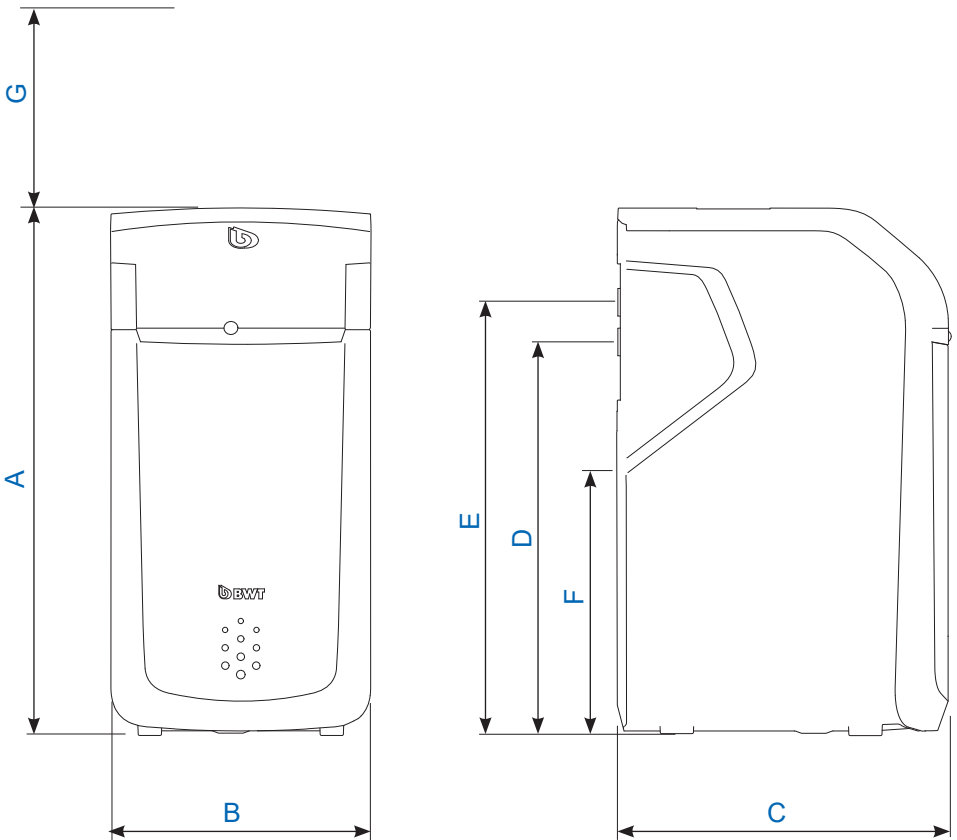

12.2 Diagram of peak flow

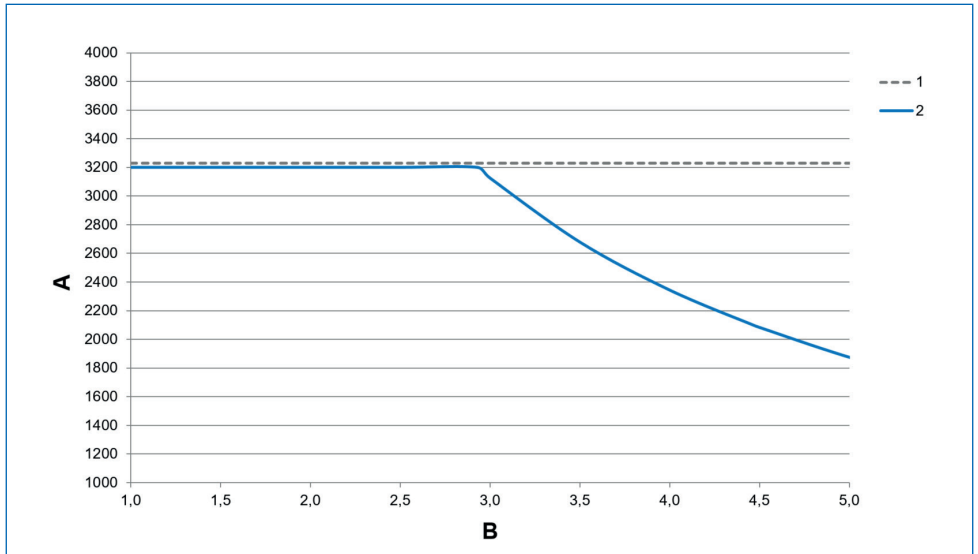

A	Peak flow	l/h
B	Inlet water hardness	mmol/l
1	1 bar pressure loss	
2	BWT Perla	

Peak flow

is the flow rate at which the product's outlet water hardness value is reduced to values less than 10% of the inflow water hardness for at least 10 minutes. The pressure difference may rise to greater than 1 bar.

Operating flow

is the flow rate on which independent testing institutions based their capacity testing (see DIN EN 14743 for details).

Nominal flow

is the flow rate at which the product causes a pressure drop of 1 bar at a water temperature of 15°C when the blending is closed.

13 Troubleshooting

13.1 Malfunctions

Fault	Cause	Remedy
Low regenerative indicator is shown.	Insufficient regenerative in the regenerative container (3). If there is still regenerative in the container, regenerative encrustation may have formed under the ultrasound sensor.	Refill the regenerative, see chapter 8.3. Loosen and stir the regenerative.
The product is not supplying softened water.	No regenerative in the regenerative container (3). Power supply interrupted. Blending not set correctly.	Refill the regenerative, see chapter 8.3. Wait 0.5 hours for brine to form. Manually initiate regeneration for both exchanger columns, one at a time. Establish electrical connection. Perform settings as described in the section "Setting the water hardness" in the "Start-up" chapter.
The product is supplying deviating outlet water hardness.	The product has not been finely adjusted. The volume flow was too low for the hardness setting.	The outlet water hardness still has to be finely adjusted. Reset the water hardness and perform fine adjustment.
No water flow.	Water supply shut off by AQA Stop.	Check the installation for leaks. Reset the AQA Stop.
The product is not supplying softened water or the flow is insufficient.	Inlet pressure is too low.	Increase inlet pressure (set pressure reducer if necessary) and start manual regeneration.
Coloured rinsing water at start-up.	Abrasion particles from exchanger resin.	Repeat start-up rinse.
The product cannot be registered. The product cannot be connected to a network. The product cannot be added to the BWT Best Water Home App.	Lack of connectivity	Contact the BWT after-sales service centre on 06203 / 7373 Monday to Thursday: 6:30 a.m. to 6:00 p.m. Friday: 6:30 a.m. to 4:00 p.m.
Implausible level indicator	Cone formation or overfilling	Uniform cone. Remove overfilling

If the fault cannot be remedied by following these steps, please contact our after-sales service department and quote the series and production number (see type plate on rear of product).



14 Decommissioning and Disposal

14.1 Shutting down the unit

The product may be shut down and dismantled only by qualified specialists.

Observe all applicable safety regulations when dismantling the system.

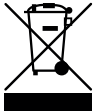
14.2 Disposal

NOTE	
	<ul style="list-style-type: none"> ▶ This product may not be disposed of in household waste. ▶ At the end of the product's life cycle, ensure that it is properly disposed of or recycled. ▶ Observe the legal disposal guidelines for the country in which the product is used.
	<ul style="list-style-type: none"> ▶ The following materials are used in the product: Metal, plastics, electronic components

Disposal of the packaging for transport

Recycling the packaging materials saves resources and reduces waste. Return the packaging to your specialised dealer.

Disposal of waste electrical and electronic devices

Do not dispose of the device in household waste. Use the official municipal collection and returns facilities for electrical and electronic waste or return the device to your dealer. By law, you are responsible for deleting any personal data on the device before disposal.

Disposal of batteries

Batteries may not be disposed of in household waste under any circumstances. Batteries not sealed inside the device must be removed and brought to a suitable collection point (such as your dealer) for disposal free of charge.

15 Standards and legal provisions

Standards and legal provisions shall always be applied in the most recent version.

- The following standards and legal regulations must be observed depending on the intended use:
- German ordinance on the quality of water for human consumption ("Trinkwasserverordnung")
- EN 806, Specifications for drinking water installations
- DIN 1988 standards, specifications for drinking water installations
- DIN EN 1717, Protection of drinking water from contaminants in the drinking water supply system
- DIN EN 15161, Water conditioning equipment inside buildings – installation, operation, maintenance and repair

The product meets the following standards:

- DIN EN 14743, Water conditioning equipment inside buildings – softeners
- DIN 19636-100, Water softeners (cation exchangers) for drinking water installation – Part 100: Requirements for use of softening units in accordance with DIN EN 14743.

16 Operating report

Section 16 of the German Drinking Water Ordinance requires you to keep an operating report in written or electronic form.

Product designation: _____

Installation location of the product: _____

Date	Water meter reading upstream of the product [m³]	Water hardness upstream downstream of the product [°dH]	Increase in sodium content of drinking water. Water hardness, upstream downstream x 8.2 mg [mg]	Regenerative refilled [kg]
			x 8.2 =	
			x 8.2 =	
			x 8.2 =	
			x 8.2 =	
			x 8.2 =	
			x 8.2 =	
			x 8.2 =	
			x 8.2 =	
			x 8.2 =	
			x 8.2 =	
			x 8.2 =	
			x 8.2 =	
			x 8.2 =	
			x 8.2 =	
			x 8.2 =	
			x 8.2 =	
			x 8.2 =	
			x 8.2 =	
			x 8.2 =	
			x 8.2 =	
			x 8.2 =	
			x 8.2 =	
			x 8.2 =	

The operating report is only required for direct or indirect, targeted drinking water supply in the context of a letting or any other independent, regular and profit-making activity.

Information in accordance with section 16 and section 21 of the German Drinking Water Ordinance

The drinking water in this building is treated as followed:

Type of treatment: Partial softening
 Metering

Product designation: _____

Installation location of the product: _____

Metering of silicate substances

For minimising the corrosiveness of drinking water and preventing elevated concentrations of heavy metals

Silicate concentration of your water, approx. _____ mg/l

Max. permitted addition in accordance with the German Drinking Water Ordinance: 15 mg/l

(calculated as SiO₂)

Metering of phosphate substances

To minimise liming, corrosiveness of drinking water and to prevent elevated concentrations of heavy metals

Phosphate concentration of your water, approx. _____ mg/l

Max. permitted addition in accordance with the German Drinking Water Ordinance: 2.2 mg/l

(calculated as P)

Metering to set the pH value

For minimising the corrosiveness of drinking water and preventing elevated concentrations of heavy metals

pH value of your water _____

Limits in accordance with the German Drinking Water Ordinance: greater than 6.5 and less than 9.5

Metering of sodium hypochlorite or chlorine dioxide solution

To increase sanitary properties of drinking water

Chlorine or Chlorine dioxide concentration of your water, approx. _____ mg/l

Max. permitted addition in accordance with the German Drinking Water Ordinance: 0.3 mg/l chlorine or 0.2 mg/l chlorine dioxide

Partial softening of drinking water by sodium ion replacement

To minimise liming

Hardness range of your water: Soft (less than 8.4°dH)
 Moderate (8.4°dH – 14.0°dH)

Sodium concentration of your water, approx.: _____ mg/l

Max. permitted concentration in accordance with the German Drinking Water Ordinance: 200 mg/l

Company: _____

Date of last maintenance: _____

EU-Konformitäts-Erklärung

EU Declaration of Conformity

UE Certificat de conformité

im Sinne der EG-Richtlinien	Niederspannung 2014/35/EU EMV 2014/30/EU Funkanlagen Richtlinie 2014/53/EU
in accordance with EC instructions	Low voltage 2014/35/EU EMC 2014/30/EU RED 2014/53/EU
en accord avec les instructions de la Communauté Européenne	Basse tension 2014/35/UE CEM 2014/30/UE Équipements radio. 2014/53/EU

Produkt/Product/Produit:	Simplex Trinkwasserbehandlungsanlage Simplex softening unit Simplex systèmes d'adoucissement d'eau
--------------------------	--

Typ/Type/Type:	BWT Perla Baureihe / series / série de modèles
----------------	---

ist entwickelt, konstruiert und gefertigt in Übereinstimmung mit den oben genannten Richtlinien, in alleiniger Verantwortung von:

has been developed, designed and produced in accordance with the above mentioned directive under the sole responsibility of:

est développé, conçu et fabriqué en accord avec les instructions mentionnées ci-dessus sous l'entière responsabilité de:

**BWT Wassertechnik GmbH, Industriestr. 7, 69198 Schriesheim,
Germany**

(WEEE-Reg. no. DE 80428986)



Schriesheim, April 2018

Ort, Datum / Place, date / Lieu et date

Lutz Hübner

Unterschrift (Geschäftsleitung)
Signature (Management)
Signature (Direction)

Further information:

BWT Austria GmbH

Walter-Simmer-Strasse 4
5310 Mondsee, Austria

Phone: +43 / 6232 / 5011 0

Fax: +43 / 6232 / 4058

E-mail: office@bwt.at

BWT Wassertechnik GmbH

Industriestrasse 7
69198 Schriesheim, Germany

Phone: +49 / 6203 / 73 0

Fax: +49 / 6203 / 73 102

E-mail: bwt@bwt.de