

BEWADES blue

UV disinfection systems

0.5 / 1.0 / 2.0 / 2.5 / 3.5

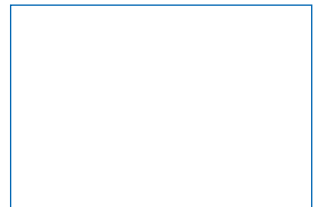

Changes reserved!



Thank you very much for the confidence that you have shown in us by purchasing a BWT appliance.



Vielen Dank für das Vertrauen, das Sie uns durch den Kauf eines BWT-Gerätes entgegengebracht haben.

Nous vous remercions de la confiance dont vous nous témoignez par l'achat d'un appareil BWT.

Table of Contents

1	Safety Instructions	4	9	System Troubleshooting	23
1.1	General safety instructions	4	10	Options	25
1.2	Scope of the documentation	4	10.1	Expansion modules	25
1.3	Personnel qualifications	5	10.2	Remote alarm connection module	25
1.4	Transport and installation	5	10.3	4-20 mA module (option)	25
1.5	Symbols used	5	11	Operator's responsibilities	26
1.6	How safety instructions are displayed	6	11.1	Intended operation	26
1.7	Product-specific safety instructions	7	11.2	Inspections	26
2	List of supplied parts	8	11.3	Inspections	27
3	Use	9	11.4	Maintenance according to EN 806-5	27
3.1	Proper use	9	12	Technical specifications	28
3.2	Foreseeable misuse	9	12.1	Water Quality Parameters	28
3.3	Disclaimer	9	13	Warranty terms	29
3.4	Other applicable documentation	9	14	Decommissioning and disposal	29
4	Function	9	14.1	Decommissioning	29
4.1	Design of UV units	9	14.2	Disposal	29
4.2	Possible flow rates of the system	9	15	Standards and legal provisions	30
5	Installation conditions	10		EU Declaration of Conformity	87
5.1	Installation site and environment	10			
5.2	Feed water	10			
5.3	Installation Control Unit	10			
5.4	Installation UV irradiation chamber	10			
5.5	Installation	11			
6	Installation diagram	12			
7	Assembly of the UV unit	13			
7.1	Cleaning the quartz glass sleeve	16			
7.2	Cleaning the UV sensor	16			
8	Operation	17			
8.1	BWT control display	18			
8.2	Automatic start sequence of the unit	18			
8.3	Operational screens (of non-monitored version)	19			
8.4	Operational screens (of monitored version)	20			
8.5	Remaining lifespan countdown of UV lamps (in days)	21			
8.6	UV lamp replacement	21			
8.7	QR codes	22			

1 Safety Instructions

1.1 General safety instructions

The product was manufactured according to all recognised regulations and technical standards and was in compliance with the relevant legal requirements when it was put into circulation.

Nevertheless, it can pose a risk of personal injury or property damage if you do not observe this chapter and the safety instructions throughout this documentation.

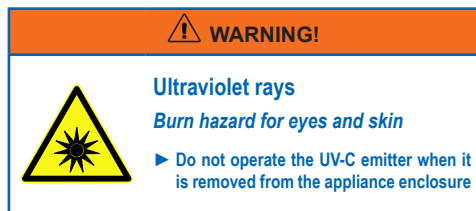

- The appliance is not to be used by persons (including children) with reduced physical, sensory or mental capabilities, or lack of experience and knowledge, unless they have been given supervision or instruction.
- Children should be supervised so that they do not to play with the appliance
- Read the instructions.
- The appliance is to be supplied through a residual current device (RCD) having a rated residual operating current not exceeding 30 mA.
- This appliance contains a UV-C emitter.
- Unintended use of the appliance or damage to the housing may result in the escape of dangerous UV-C radiation. UV-C radiation may, even in little doses, cause harm to the eyes and skin.
- Precautions to be taken when replacing UV-C emitters.
- The appliance must be disconnected from the supply before replacing the UV-C emitter.
- The appliance is intended to be permanently connected to the water mains and not connected by a hose-set.
- Maximum working voltage of built-in UV driver U-OUT=240V
- If the supply cord is damaged, it must be replaced by the manufacturer, its service agent or similarly qualified persons in order to avoid a hazard.
- Read this documentation thoroughly and in full before working with the product.

- Retain the documentation in such a way that it is accessible to all users at all times.
- Always hand over the product to third parties together with the full documentation.
- Follow all of the instructions in relation to the proper handling of the product.
- If you detect damage to the product or the mains supply, stop its operation and notify a service technician immediately.
- Use only accessories, spare parts and consumable materials that have been approved by BWT.
- Adhere to the environmental and operating conditions specified in the “Technical data” chapter.
- Use your personal protective equipment. It ensures your safety and protects you from injury.
- Only perform tasks that are described in these operating instructions or if you have been trained to do so by BWT.
- Perform all tasks in compliance with all applicable standards and provisions.
- Instruct the operator in the function and operation of the product.
- Instruct the operator in the maintenance of the product.
- Instruct the operator in relation to potential dangers that may arise while operating the product.

1.2 Scope of the documentation

This documentation applies exclusively to the product the production number of which is listed in chapter 12 “Technical Data”.

This documentation is intended for operators, installers without training from BWT, installers with training from BWT (e.g. drinking water specialists), and BWT service technicians.

This documentation contains important information for fitting the product safely and properly, starting up, operating, using, maintaining, and disassembling the product, and for correcting simple faults independently.

Read this documentation in full before working with the product. Pay particular attention to the chapter “Safety Instructions”.

1.3 Personnel qualifications

The installation work described in these instructions requires basic knowledge of mechanics, hydraulics and electrical systems as well as knowledge of the corresponding specialist terms.

To ensure that the device is installed safely, this work must be performed only by a qualified specialist or a trained person under the guidance of a qualified specialist.

A **qualified specialist** is anyone who can assess the work assigned to him or her, identify potential risks, and take suitable safety measures thanks to his or her specialist training, knowledge and experience as well as his or her knowledge of the applicable regulations. A qualified specialist must comply with the applicable specialist regulations.

An **instructed person** is anyone who has been instructed and, if necessary, trained by a qualified specialist in the transferred tasks and the potential risks presented by improper behaviour and who has been educated about the necessary protective equipment and measures.

1.4 Transport and installation





To avoid damage during transport to the installation location, do not remove the BWT product from the packaging until you have reached the relevant location. Then dispose of the packaging in the correct manner. Check that the delivery is complete.

If there is a risk of frost, drain all components that convey water.

Lift or transport the product or its components only from the designated suspension eyes or attachment points, if present.

The product must be installed or mounted on a sufficiently strong and level vertical surface and must be adequately secured against falling or tipping.



1.5 Symbols used

	This symbol indicates general hazards for people, machines or the environment.
	This symbol indicates hazards due to electric shocks from live components.
	This symbol indicates hazards for the eyes and skin due to ultraviolet rays.
	This symbol indicates that this electrical and electronic equipment must not be disposed of with household waste at the end of its life.
	This symbol indicates that the product can be recycled at the end of its life.
	This symbol instructs you to disconnect the unit's power supply. It ensures your safety and protects you from injury. Here: Main switch off (0).
	This symbol instructs you to use your personal protective equipment (PPE). It ensures your safety and protects you from injury. Here: Wear protective goggles.

EN 1.6 How safety instructions are displayed

In this document safety instructions precede any sequence of actions that could cause harm to persons or damage to property. All hazard prevention measures must be followed.

Safety instructions are displayed as follows:

 SIGNAL WORD!	
	<p>Source of hazard (e.g. electric shock)</p> <p><i>Type of hazard (e.g. risk of fatal injury)</i></p> <ul style="list-style-type: none"> ▶ Escape or prevent hazard ▶ Rescue measure (optional)

Signal word	Colour	Severity of the hazard
DANGER		<p>High-risk hazard.</p> <p>Indicates a hazardous situation which, if not avoided, will result in death or serious injury.</p>
WARNING		<p>Hazard with a moderate degree of risk.</p> <p>Indicates a hazardous situation which, if not avoided, could result in death or serious injury.</p>
CAUTION		<p>Low-risk hazard.</p> <p>Indicates a hazardous situation which, if not avoided, may result in minor or moderate injury.</p>

Signal word / colour	Indicates the severity of the hazard
Warning symbol	Calls attention to the hazard
Source / type of hazard	Indicates the type and the source of the hazard
Consequences of hazard	Explains the consequences of not following the safety instructions
Hazard prevention measure	Explains how to avoid the hazard

1.7 Product-specific safety instructions

In the following sections, you will find product-specific safety instructions whenever you must perform certain safety-relevant actions on the device.

DANGER!



Electrical hazard!

Contact with live components will cause electric shock.

- ▶ Unplug device before any service and repair works.

WARNING!



Ultraviolet rays

Burn hazard for eyes and skin

- ▶ Only start up the unit with the black protective gland nut on.
- ▶ Never look into the open sensor socket without integrated glow plug or sensor.
- ▶ Wear personal protective equipment (protective goggles).



WARNING!



Dangerously hot water!

Danger of scalding!

- ▶ Insufficient water withdrawal
- ▶ Open the tap and discard a small amount of water before use.

WARNING!



Device under pressure!

Parts or liquids may be pushed out!

- ▶ Turn off water supply and depressurize device before any service and repair works.

2 List of supplied parts

Bewades Blue consisting of:

1	Controller
2	Lamp key
3	Gland nut
4	O-ring
5	UV lamp
6	Quartz glass sleeve
7	Reactor
8	Optional UV sensor
9	Glow plug

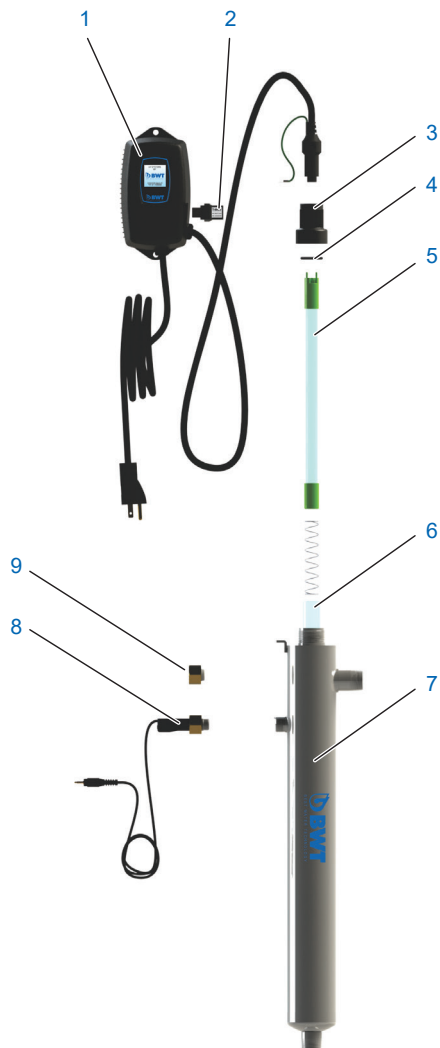

3 Use

3.1 Proper use

The Bewades Blue UV disinfection unit is used to disinfect drinking water.

The UV disinfection process does not change the pH value, colour or taste of the water.

3.2 Foreseeable misuse

Operating the unit with systems other than those specified in this documentation.

Failure to comply with the operating and ambient conditions specified in section 12.

Not adhering to the prescribed maintenance and service intervals.

Using spare parts and consumables not approved by BWT.

3.3 Disclaimer

The manufacturer is released from any liability if the customer intentionally or forcibly removes guards or safety devices, if the customer wilfully modifies or circumvents the same, or if the customer does not follow the instructions in this operating manual or on the system.

3.4 Other applicable documentation

Observe all documents from suppliers that were included with delivery. These are considered part of this documentation and must not be changed or removed.

4 Function

The water to be treated flows upwards through the stainless steel radiation chamber.

The UV lamp is located in a lamp protection tube made of high-grade quartz with a high level of UV transparency.

The UV lamp generates UVC rays at a wavelength of 254 nm, which are particularly effective for disinfection.

In general, disinfection means a 99.99 % reduction in the pathogenic germs found in drinking water (4 log levels).

Exposure to UVC light leads to a loss of the ability of the micro-organisms in the water to multiply (reproductive cell death), so they no longer pose a danger to human health.

The optional sensor continuously monitors the performance of the UV system and displaying the output in % via a colour screen.

Bewades Blue UV systems are supplied ready wired.

4.1 Design of UV units

UV unit design is primarily based on the following parameters:

- Maximum flow (m³/h)
- UV absorption of the water to be treated at 254 nm

Specified by SSK-254 nm (1/m) or UV transmittance based on a defined layer thickness (e.g. %/cm).

4.2 Possible flow rates of the system

All BWT UV systems are rated for a specific flow rate with water that meets the quality parameters in chapter 12, Technical Specifications. Please note that increasing the flow above this rating or disinfecting water that does not meet the quality parameters will decrease the dose and therefore compromise the microorganism inactivation.

5.1 Installation site and environment

The installation site must be protected against frost and kept free of chemicals, paint, solvents and fumes. Neither the ambient temperature nor the radiation temperature may exceed 40 °C in the immediate vicinity.

There must be a clearance above the unit to facilitate lamp replacement.

The emission of interference (voltage peaks, high-frequency electromagnetic fields, interference voltages, voltage fluctuations, etc.) by the surrounding electrical systems may not exceed the maximum values specified in EN 61000-6-4.

5.2 Feed water

The water to be fed into the unit must always meet the specifications given in chapter 12, Technical specifications (see UV transmittance values). The hydraulic conditions must be such that a vacuum can never form in the UV unit.

Avoid pressure surges and fluctuating loads (e.g. from pumps starting, pressure booster pulsation, quickly closing valves, etc.).

Suitable installations for avoiding pressure surges or fluctuating loads (e.g. expansion vessels, compressed air chambers, slowly closing valves, etc.) must be installed externally.

5.3 Installation Control Unit

The control unit has a hole at the top and bottom for wall mounting.

- Fasten the control unit to a sufficiently stable flat surface with suitable dowels and screws.
- The control elements and the display must be easily accessible and visible.
- All cables (power supply, sensor, UV irradiation chamber) must be properly laid and fastened if necessary.

5.4 Installation UV irradiation chamber

To mount the UV irradiation chamber, use the mounting material supplied with the system. The UV irradiation chamber should preferably be mounted vertically on a sufficiently load-bearing, flat surface.

- Fix both holding clamps (1) to the wall with suitable dowels and the enclosed screws at a suitable distance.
- Insert the UV irradiation chamber into the holding clamps.
- Make sure that one clamp is fixed under the laterally oriented water outlet.
- Close the holding clamps with the closure segments (2).
- Check assembly for tight fit
- Install piping

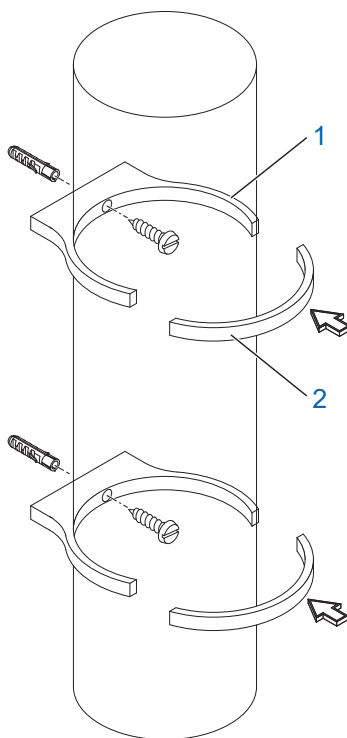

5.5 Installation

Use corrosion-resistant pipe materials for installation. Take corrosion-causing chemical properties into consideration when different pipe materials are combined (mixed installation).

A protective filter must always be installed upstream from the unit to protect it from foreign particles.

In certain circumstances, the water must be pre-treated. Depending on the operating conditions and water quality, the water may be partially softened to prevent deposits on the lamp casing tubes.

WARNING!



Dangerously hot water!

Danger of scalding!

- ▶ Insufficient water withdrawal
- ▶ Open the tap and discard a small amount of water before use.

NOTE



- ▶ On site a flushing valve should be installed after the Bewades blue, which transfers the water out of the irradiation chamber to the drain when the water temperature exceeds the operation temperature (detection via temperature switch).

For **Point of Entry (POE)** systems, choose a location where the main cold water line is accessible. The system must be installed after other water treatment equipment (softener or filters), but before any branches (see Fig. 1).

For **Point of Use (POU)** systems, install the unit just before the faucet. BWT recommends that a 5 µm filter be installed before the UV system before the water is disinfected.

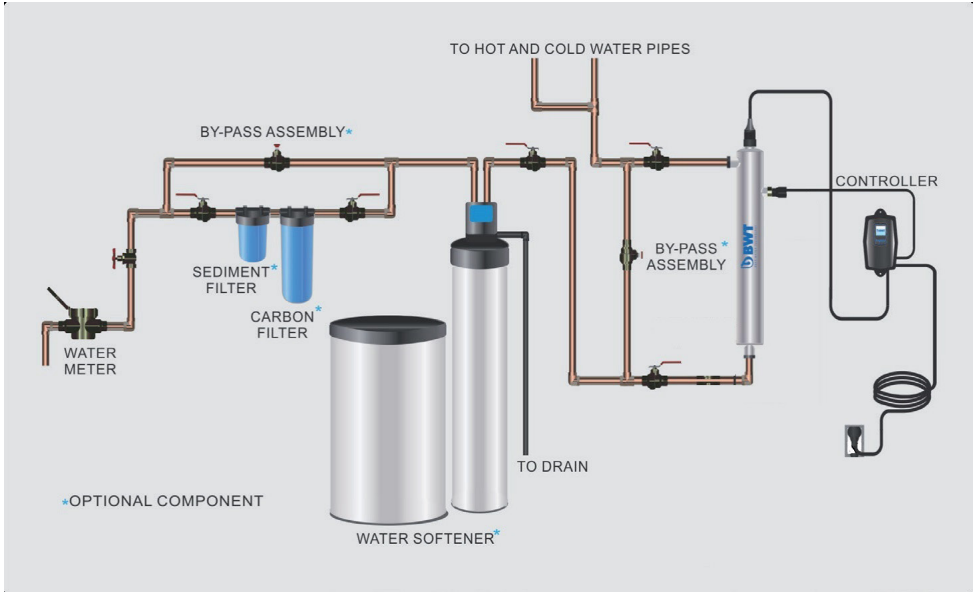

Fig. 1: Assembly recommendation for UV unit BWT Bewades Blue (for POE).

NOTE

▶ Installation of sampling ports for microbiological sampling is strongly advised

7 Assembly of the UV unit

Please unpack the UV unit and ensure all the components of the scope of delivery are included.



Fig. 3: Assembly of the bypass

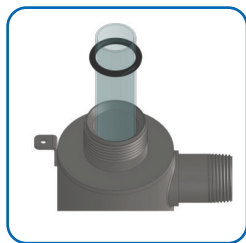

Fig. 4: Installation of the quartz glass sleeve

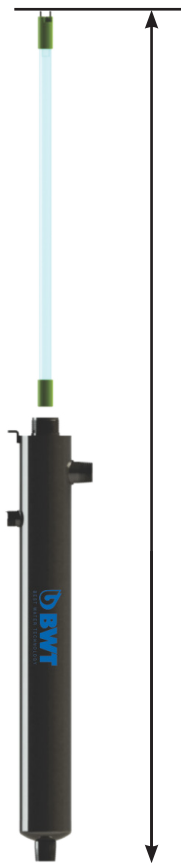

Fig. 2: Removal spacing for UV-lamp disassembly

- 1: The reactor can be installed either horizontally or vertically using the clamps provided. Vertical installation is the preferred method with the inlet at the bottom (lamp connection at the top) as it allows any air that may be in the lines to be easily purged from the system.
- 2: The use of a by-pass assembly is recommended as it will allow you to isolate the UV reactor. This will allow easier access in case maintenance is required (see Fig. 3).
- 3: Use the supplied fasteners to mount the UV reactor to wood or drywall. If mounting to an alternate material you will need to purchase the proper corresponding fasteners.
- 4: For water supplies where the maximum flow rate is unknown, a flow restrictor is recommended so that the rated flow of your particular BWT system is not exceeded. The flow restrictor should be installed on the outlet port of the reactor.
- 5: It is recommended to have a licensed plumber connect the UV unit to the water supply. This may be a requirement depending on where you are located.
- 6: Once the system has been plumbed in, gently remove the quartz glass sleeve from its packaging being careful not to touch the length with your hands. The use of clean gloves is recommended for this procedure as oils from the hands can leave residue on the sleeve and lamp which can ultimately block the UV light from getting to the water.

Carefully slide the glass sleeve into the reactor until you can feel it hit the opposite end of the reactor. Align the sleeve so it is centered along the length of the reactor, then gently push it in to lock it into the internal centering springs in the far side of the reactor.

ATTENTION:

Pushing too hard when the sleeve is not aligned can damage the centering springs. Slide the o-ring onto the sleeve until it is butted up against the reactor.

- 7: Hand tighten the provided gland nut over the quartz sleeve onto the threaded end of the reactor. It has a positive stop to prevent over-tightening. A firm force may be required to fully tighten the gland nut, but do not use tools for this step. Insert the provided stainless steel compression spring into the quartz sleeve. The spring works with the lamp and lamp connector to create the proper lamp alignment.

OBSERVE:

Do not install a UV lamp inside the quartz sleeve without the sleeve spring in place.

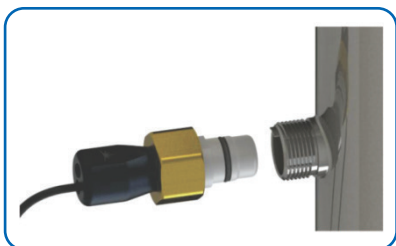
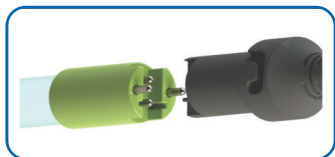

Fig. 5: Installation of the UV sensor



Fig.6: IEP connection



7a: Standard output of the UV- lamp connection

- 8: Install the UV sensor (monitored systems only). Align the flat portion so it faces the gland nut end and matches up with the half metal lip on the sensor port (see Fig. 5). Insert the sensor so it is fully seated and hand tighten the sensor nut.
- 9: The reactor is now ready for water flow. When all plumbing connections have been completed, slowly turn on the water supply and check for leaks. Make sure the by-pass valves are functioning properly and that the water is flowing through the reactor. The most common leak is from the o-ring not making a proper seal on the reactor. For new installations, review steps 6 and 7. For older systems drain the reactor, remove the o-ring, dry it and reapply silicon grease. Reinstall the o-ring ensuring that it is properly sealed against the reactor and check again for leaks.
- 10: Mount the controller unit to the wall so it is above or beside the reactor to ensure that no moisture can deposit on any of the connections (see Fig. 1). Always mount the controller vertically. For monitored systems, insert the sensor connector into the IEP port located on the right side of the controller (see Fig. 6). For the sensor to be recognized by the controller, the controller power must be plugged in last. Do not plug the controller power cord in before the last step.
- 11: Always hold UV lamps by their ceramic ends, not by the lamp quartz. Remove the lamp from its packaging. Again, the use of clean gloves is recommended. Remove the lamp key from the lamp's connector and set it aside for the next step. Be careful not to touch the key's exposed contacts. Insert the UV lamp into the reactor, being careful not to drop it.



Fig. 8: Insertion of the lamp key



Fig. 9: The lamp connector

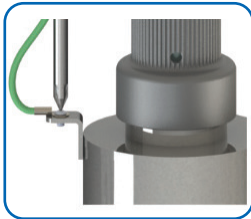

Fig. 10: Ground screw connection

- 12: Install the lamp key into the controller. The key always comes packaged with the lamp and sits on the connector. With the key removed from the lamp, orient it so the label is upright and facing you. The key will plug into the lamp key port on the right side of the controller (see Fig. 8).
- 13: Plug the lamp connector into the lamp. Note the keying for proper alignment (see Fig. 7). Insert the lamp connector into the gland nut and turn the connector approximately $\frac{1}{4}$ turn to lock the connector to the gland nut as in Fig. 9.
- 14: Tighten the captive ground screw (see Fig. 10) to the ground lug on the UV reactor to ensure proper grounding.
- 15: Your system is now ready to be plugged into the appropriate GFCI protected outlet. Refer to the following section before any water is allowed to flow through the system!

Depending on the water quality, the quartz sleeve may require periodic cleaning. At a minimum, the quartz sleeve should be cleaned on an annual basis. The steps 1-11 outline a basic cleaning procedure.

ATTENTION:

UV lamps are very hot and must cool down approx. 5 minutes.

- 1: If a by-pass assembly is installed, shut the inlet valve off to prevent water flow through the UV system. Otherwise, turn off the main water inlet valve (and/or turn off the water pump).
- 2: Plug out the power plug of UV system from electrical outlet.
- 3: Release the remaining water pressure by opening a downstream faucet and then close the outlet shut-off valve (if any is present). If there is no outlet shut-off valve, expect water to drain from the system as the head pressure in the system will cause the water to flow back down.
- 4: Remove the captive ground screw from the ground lug on the UV reactor.
- 5: Remove the lamp connector from the reactor (gland nut) by pushing the lamp connector in and turning it $\frac{1}{4}$ turn counterclockwise. Now disconnect the lamp connector from the UV lamp.
- 6: Being careful to touch only the ceramic ends, remove the lamp out of the reactor!
- 7: Unscrew the gland nut from the reactor exposing the end of the quartz glass sleeve.
- 8: Now remove the quartz glass sleeve together with the o-ring out of the reactor by gently twisting and pulling the quartz glass sleeve.
- 9: Using a soft, fiber-free cleaning cloth or microfibre towel wipe the sleeve down using a commercial scale cleaner. This removes scaling or iron deposits that may be on the outside of the quartz glass sleeve. Be careful not to get any moisture or liquids inside of the quartz glass sleeve.
- 10: Dry the quartz glass sleeve with a separate microfibre cloth.
- 11: Replace the o-ring and slide the sleeve back into the reactor following step 6 from chapter 8.

Depending on the water quality, the UV sensor may require periodic cleaning. At a minimum, the UV sensor should be cleaned on an annual basis. The following steps outline a basic cleaning procedure.

- 1: If a by-pass assembly is installed, shut the inlet valve off to prevent water flow through the system. Otherwise, turn off main water inlet valve (and/or turn off the water pump).
- 2: Plug out the power plug of UV system from electrical outlet.
- 3: Release the remaining water pressure by opening a downstream faucet and then close the outlet shut-off valve (if any is present). If there is no outlet shut-off valve, expect water to drain from the system as the head pressure in the system will cause the water to flow back down.
- 4: Place an collecting container under the reactor to catch any water that may flow out of the reactor during the removal of the UV sensor.
- 5: Unscrew (counterclockwise) sensor nut from the reactor and pull the sensor slowly out of the sensor port.
- 6: Holding the sensor in your hand wipe the flat portion (sensor face) of the sensor with isopropyl alcohol using a clean microfibre cloth.
- 7: Replace the new sensor by following step 8 from chapter 7, page 13 of this manual.

BWT Bewades blue systems are equipped with a control unit in which the ballast unit and the operating display are installed. The sensor-monitored system is equipped with a DC-operated UV sensor that can measure the UV intensity (via current measurement). The standard signal is converted to a UV intensity value in [%] and shown on the display.

OBSERVE:

While the display screen is red and the buzzer is sounding the water from the system should not be consumed. If any water does pass through the system during this period, please follow the disinfection procedure as outlined in this manual before the water is consumed. For non-monitored systems, even though they have a visual and audible warning built into the controller, a green status screen does not necessarily indicate that the water coming from this system is in fact potable (is safe to drink). These systems do not measure the level of disinfection; they simply measure the “on-off” status of the lamp. Please have your water checked for microbiological contaminants on a regular basis.

 **WARNING!**



Ultraviolet rays
Burn hazard for eyes and skin

- ▶ Only start up the unit with the black protective gland nut on.
- ▶ Never look into the open sensor socket without integrated glow plug or sensor.
- ▶ Wear personal protective equipment (protective goggles).



A full colour LCD screen provides the user with a detailed description of the UV system's performance in addition to providing any applicable fault messages and system diagnostics. The controllers used in both the un-monitored and monitored systems are identical. The difference is that the monitored series of products include a UV intensity monitor. All BWT controllers include an "infinite expandability port" located on the right side of the controller. Simply plug in an optional UV sensor module into the expandability port of a BWT controller and the system will now monitor the UV intensity of the system!

8.2 Automatic start sequence of the unit

On start up, the controller will run through a diagnostic start-up and the sequence will show the power-up displays with an BWT logo:

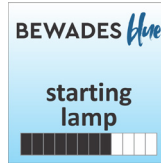
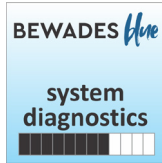

Next, the controller checks for and initializes any optional modules that may be attached to the UV system.

Functional check of:
UV sensor

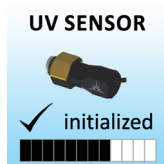
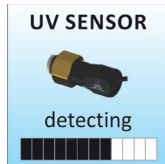

OR

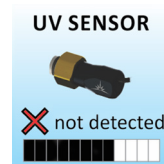

Functional check of:
Solenoid valve

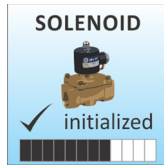
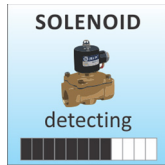

OR

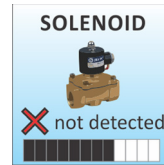

Functional check of:
4-20 mA connection

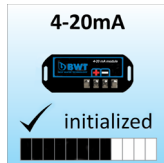
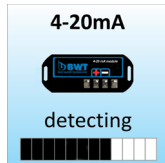

OR

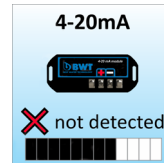

Functional check of:
Ethernet connection

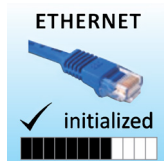
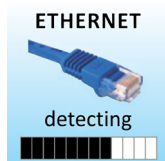

OR

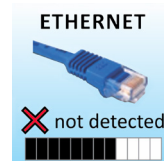

Remote Alarm
Module Check



OR



A further display screen is showing which “specific modules” were initialized.

The controller then displays the “UV lamp optimization” screen for 60 seconds to allow the lamp to reach its optimum output. Finally, a final “start-up complete” screen is displayed. The system will now be ready to disinfect water flow.

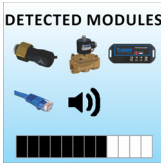

all detected modules

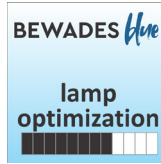

lamp reaching max. output



successful start-up

8.3 Operational screens (of non-monitored version)

On units without the UV-sensor monitoring, the default screen shows the BWT Home Screen (No.1). At any point during operation the user is able to scroll through the BWT Home Screen (No.1), Lamp life remaining (No.2), QR Code (No.3), Contact Info (No.4) and Maintenance Parts (No.5) screens by pressing the button located on the front of the controller.

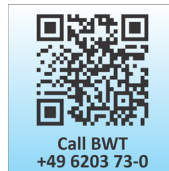

EN 8.4 Operational screens (of monitored version)

While the UV unit type „without sensor“ only displays a start-up display, the UV systems „with sensor“ displays the below listed measurement screens with the UV intensity. The UV intensity screen displays the [%] value of UV light detected by the sensor.

UV intensity can be affected by:

- poor water quality
- scaling on the contamination on the quartz sleeve
- malfunction of the UV sensor
- failure of UV lamp or UV lamp expiring

The following screens indicate the UV intensity is dropping.

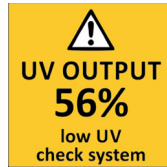
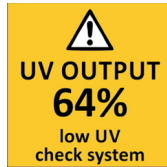
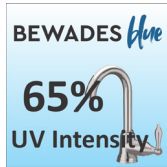
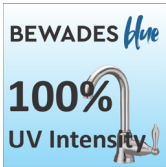

Below 56 %, the numbers and warning sign turn red and an audible chirp is given by the ballast every 15 seconds. Below 51 %, the screen is solid red and a constant audible alarm is given. This alternates with a screen indicating "water may be unsafe for consumption". With the solenoid module, the controller de-activates the solenoid valve, shutting off all water flow.

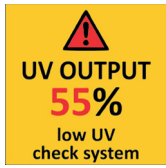

audible chirp every 15 seconds

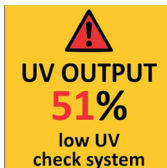

audible chirp every 15 seconds

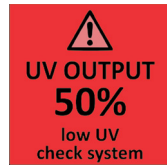

constant audible alarm



cycles with red low UV screen

8.5 Remaining lifespan countdown of UV lamps (in days)

The system counts down the number of days until a UV lamp change is required.



At 30 days remaining, the operating display screen will change to a yellow warning indicator. At 7 days remaining, the UV unit will additionally repeat an audible alarm sound. In the event that the zero-day threshold limit has been exceeded, the display screen changes to solid red and a continuous buzzer will be output.

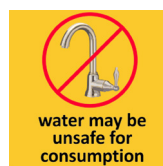

At any point during this sequence, the warning tone or alarm screen can be deferred for seven days by holding the controller button down for a period of five seconds. The number of deferrals used will be displayed as below. Once the deferral expires, the alarm will sound once again. The deferral can be repeated up to three times.

OBSERVE: At any point after lamp expiration, the water may be unsafe for consumption and should not be consumed without another form of disinfection.



8.6 UV lamp replacement

After the UV lamp is expired, it must be replaced with the identical part number as indicated on the "Maintenance Parts screen" or on the label on the reactor (with the same serial number and number of watts). With the system powered down, remove and discard the UV lamp key from the controller. The replacement lamp is packaged with a lamp key on the connector at the end of the lamp. Remove the key from the lamp and place it in the controller. Refer to Installation, starting with step 11 (Chapter 7 on page 13) for instructions on installing the new lamp.



8.7 QR codes

To get additional product and maintenance information, please press the front button of your UV unit until the QR code is shown.

Ensure your mobile device has web access and a QR-code scanning app is installed.







Start your QR-code scanning app and scan the QR-code **shown on the display of your UV unit** (do not scan the example shown on the left).

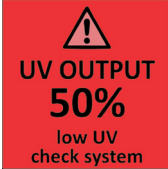

BWT service technicians have the following possibilities:

- 1: Looking up identical spare parts components.

Hardstop alarms:

The following system alarms produce a permanent audible sound. If present, the solenoid valve is closed. The alarm output is transmitted by the 4-20 mA contacts, remote alarm- and ethernet modules.





System display	Problem	Resolution
 <p>DANGER lamp failure replace lamp CALL BWT +49 6203 73-0</p>	The UV system has detected a problem with the UV lamp.	<p>Reset of the lamp protection circuit - safety unplug unit for 10 seconds.</p> <p>Replace the identical UV lamp as indicated with the spare part no. on the silver label of the UV reactor or on the maintenance parts display.</p>
 <p>DANGER lamp expired 1 days ago CALL BWT +49 6203 73-0</p>	Although the UV lamp is switched on and is visible, the UV output is no longer sufficient for proper disinfection.	Replace the identical UV lamp as indicated with the spare part no. on the silver label of the UV reactor or on the maintenance parts display.
 <p>UV OUTPUT 50% low UV check system</p>	UV intensity too low.	Remove and clean the quartz glass sleeve and sensor. Check that the water quality meets requirements and add a filter as required. Replace the UV lamp.
 <p>LAMP INCORRECT</p>	Wrong UV lamp or UV sensor has been installed.	Remove wrong parts and replace with correct spare part component as specified.
 <p>UV SENSOR FAILURE</p> <p>check connection or see manual</p>	The UV sensor no longer communicates with the UV system.	<p>Ensure that all modules are plugged in properly and the UV system detects the correct connection.</p> <p>The modules can be tested individually by plugging them in one after each other and rebooting the UV system.</p>
 <p>CONNECTION FAILURE</p> <p>check connection or see manual</p>	A bad connection has been detected in the IEP port.	Replace any module that could not be detected when it was plugged directly into the controller.

System display	Problem	Resolution
<p>LAMP KEY NOT FOUND</p>  <p>check connection or see manual</p> <p>LAMP KEY INVALID</p>  <p>check connection or see manual</p>	<p>Missing or incorrect lamp key was detected.</p>	<p>Ensure that the supplied lamp key is installed. Unplug the old key.</p> <p>Ensure that the identical part no. of the new lamp key fits to the new UV-lamp.</p>

Boil water information: If any failure occurs on a BWT UV system, the (incompletely treated) water is not suitable for human consumption and must therefore be boiled for 20 minutes prior to consumption. This procedure you have to observe until the UV unit is repaired and disinfected as well as put into operation again.

WARNING:

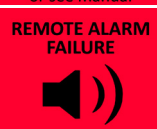
After every hardstop alarm signal and standstill of the unit, the house pipes or UV unit should be disinfected.

System display	Problem	Resolution
<p>SOLENOID FAILURE</p>  <p>check connection or see manual</p> <p>4-20 mA FAILURE</p>  <p>check connection or see manual</p> <p>REMOTE ALARM FAILURE</p>  <p>check connection or see manual</p> <p>ETHERNET FAILURE</p>  <p>check connection or see manual</p>	<p>The module indicated is no longer communicating with the system.</p>	<p>Ensure that all modules are plugged in properly and the UV system detects the correct connection.</p> <p>The modules can be tested individually by plugging them in one after each other and rebooting the UV system.</p> <p>Replace any module that could not be detected when it was plugged directly into the controller.</p>



10 Options

10.1 Expansion modules

BWT controllers incorporate an “Infinite Expandability Port” (IEP) which allows for expansion to the UV sensor and all other modules. Each module (including the sensor) comes with both a male and female connection. Connect any device to the controller and all subsequent devices are then connected into the female end of the last device added in a “daisy chain” configuration.

The optional expansion modules are available for use on all BWT controllers. Contact your authorized distributor for purchasing information.

10.2 Remote alarm connection module

Allows a connection to a remote device such as a buzzer, light, alarm system, PLC, etc., via a pair of contacts. In normal operation the OK and COM contacts will be connected, and in a fault condition (low UV, lamp fail, power fail), the fault and COM contacts will be connected. Maximum contact rating is 1A-120V AC/DC (use 16-22 AWG).



10.3 4-20 mA module (option)

Outputs a 4-20 mA signal of the UV output to a remote device such as a data logger or computer.



You have purchased a durable and service-friendly product. However, this also entails obligations. For a perfect function you must ensure:

- Intended operation.
- Regular inspections and service work.

In case of changes in water quality or flow rates, the limits of use of the system must be checked. Prerequisites for the function and safety of the product are inspections, regular inspections (every 2 months) by the operator and a half-yearly (every 6 months) routine maintenance (EN 806-5) of the entire drinking water installation. A further prerequisite for function and warranty is the replacement of wear parts at the prescribed intervals.

11.1 Intended operation

The intended operation of the product includes commissioning, operation, decommissioning and, if necessary, recommissioning. Proper operation of the product and the drinking water installation requires regular checks, servicing and operation in compliance with the operating conditions used for planning and installation.

11.2 Inspections

(by the operator)

BWT recommends that the operator regularly carries out and logs the following checks:

Water pressure:

If the pressure conditions change, the limits of use of the system must be checked.

Water quality:

If the water quality changes (UV transmittance), the operating limits of the system must be checked.

Flow rate:

If the flow rate (l/min) changes, the operating limits of the system must be checked.

Operating status of the product:

Checking whether error messages were issued.

Tightness:

Checking whether water escapes from the system.

Contamination and calcification:

Check whether foreign particles or deposits influence the proper operation of the device.

Condition of the device:

Check whether there is damage and whether all parts are in the intended place.

11.3 Inspections

(according to EN 806-5 by the operator)

Inspection activity	Intervall
Control Change of pressure conditions	every 2 months
Control Change in water quality (UV transmittance)	every 2 months
Flow rate change control (l/min)	every 2 months
Checking the operating status of the product	every 2 months
Product tightness check	every 2 months
Control of soiling and calcification of the product	every 2 months
Product condition control	every 2 months

11.4 Maintenance according to EN 806-5

(by BWT customer service or authorized specialist)

Part exchange

The operator must ensure that parts which are subject to wear and ageing during the service life of the product are replaced by BWT customer service or an authorised specialist.

The detailed replacement cycles can be seen in the table below.

Replacement of wearing parts	Range
Emitters	every 9000 hours (after one year of operation) or at the end of the specified period.
Quartz glass tube and UV sensor	every 4 years

Cleaning of wearing parts	Range
Quartz glass tube and UV sensor	every 6 months

EN 12 Technical specifications

Type		0.5	1.0	2.0	2.5	3.5
Flow Rate 30 mJ/cm ² @ T ₁₀₀ mm = 95% UVT	l/min	11	23	41	57	79
	m ³ /h	0,7	1,3	2,5	3,4	4,8
Flow Rate 40 mJ/cm ² @ T ₁₀₀ mm = 95% UVT	l/min	9,1	17	31	45	59
	m ³ /h	0,5	1	2	2,5	3,5
Tubing port size	NPT	1/2" F	3/4" M	3/4" M	1" M	1" M
Electrical connection	V/Hz/A	100-240 / ~50-60 / 1 MAX				
Lamp connection power	W	15	22	39	50	42
Energy consumption	W	20	30	49	62	51
Reactor dimensions	mm	64 x 343	64 x 520	64 x 873	64 x 1060	89 x 925
Chamber material		304 stainless steel / A249 with pressure rated tubing				
Controller dimensions	mm	172 x 92 x 102				
Pressure rating	bar (g)	0 - 10 (no vacuum)				
Operating temperature water / ambient"	°C	5 - 30 / 5 - 40				
Shipping Weight	kg	3,6	4,4	6	6,5	8,2
Production number basic unit	PNR	6-180707	6-180708	6-180709	6-180710	6-180711
UV sensor	PNR	6-181045				6-181046
Remote Alarm Module	PNR	6-181060				
4-20 mA Module	PNR	6-181059				

12.1 Water Quality Parameters

UV disinfection is extremely effective against microorganisms but only if the UV light can pass through the water it needs to treat. This means that the quality of your water is very important in order to ensure complete disinfection. Treated water should be tested for at the least the parameters listed below. If the water exceeds the listed parameters BWT strongly recommends that appropriate pretreatment equipment be installed (equipment required will depend on parameters being treated):

Hardness	< Hardness should be below 1,5 mmol/l otherwise the quartz sleeve must be cleaned periodically in order to ensure efficient UV penetration.
Iron (Fe) + Manganese	The sum should be below 0,1 ppm
Turbidity	< 1 NTU
UVT (transmittance)	> 85 %/100 mm (Please contact BWT if water has a UVT that is less than 80 %/100 mm for pre-treatment recommendations)

You can have your water tested at a private analytical laboratory or by your local dealer. It is always recommended to install pre-filtration of at least 5 microns prior to a BWT UV disinfection system.

13 Warranty terms

If the product malfunctions during the warranty period, contact your contract partner, the installation company, and quote the unit type and production number (see Technical specifications or the type plate on the unit).

Non-compliance with the installation conditions and the operator responsibilities voids the warranty and disclaims liability.

The wearing parts defined in the "Operator responsibilities" section and the consequences of failing to replace these parts on time are not covered by the 2-year legal warranty.

BWT assumes no liability in the event that the unit fails or if the capacity becomes deficient due to incorrect material selection/combination, floating corrosion products or iron and manganese deposits, or any resulting damage thereof.

14 Decommissioning and disposal

14.1 Decommissioning

The product may only be shut down and dismantled by qualified specialists.

Observe all applicable safety regulations when dismantling the system.

14.2 Disposal

NOTICE	
	<ul style="list-style-type: none"> ▶ The product must not be disposed of with household waste. ▶ At the end of the product's life cycle, ensure that it is properly disposed of or recycled. ▶ Observe the legal disposal guidelines for the country in which the product is used. ▶ The following materials are used in the product: metal, plastic, electronic components.

Disposal of transport packaging

Returning the packaging into the material cycle saves raw materials and reduces the amount of waste. Your dealer will take the packaging back.

Disposal of the old device

Do not dispose of your old appliance with household waste. Use the official collection and return points for the return and recycling of electrical and electronic equipment at local authorities or dealers. You are legally responsible for deleting any personal data on the old device to be disposed of.

Disposal of used batteries

Batteries must never be disposed of with household waste. Used batteries that are not firmly enclosed by the device must be removed and disposed of at a suitable collection point (e.g. retail outlet), where they can be handed over free of charge.

Disposal of lamps

The lamps contain mercury and should therefore be disposed according to your local requirements which apply for mercury-containing lamps.

15 Standards and legal provisions

Standards and legal provisions shall always be applied in the most recent version.

- Specifications for installations inside buildings conveying water for human consumption - Part 1: General; German version EN 806-1:2000 + A1:2001
- Water conditioning equipment inside buildings - Devices using mercury low-pressure ultraviolet radiators - requirements for performance, safety and testing; German version EN 14879:2006

For more information contact us:

BWT Austria GmbH

Walter-Simmer-Straße 4
A-5310 Mondsee
Phone: +43 / 6232 / 5011 0
Fax: +43 / 6232 / 4058
E-Mail: office@bwt.at

BWT Wassertechnik GmbH

Industriestraße 7
D-69198 Schriesheim
Phone: +49 / 6203 / 73 0
Fax: +49 / 6203 / 73 102
E-Mail: bwt@bwt.de