

**Instruction manual
Ecosoft® media systems**

**Руководство по монтажу и настройке
систем очистки воды Ecosoft®**

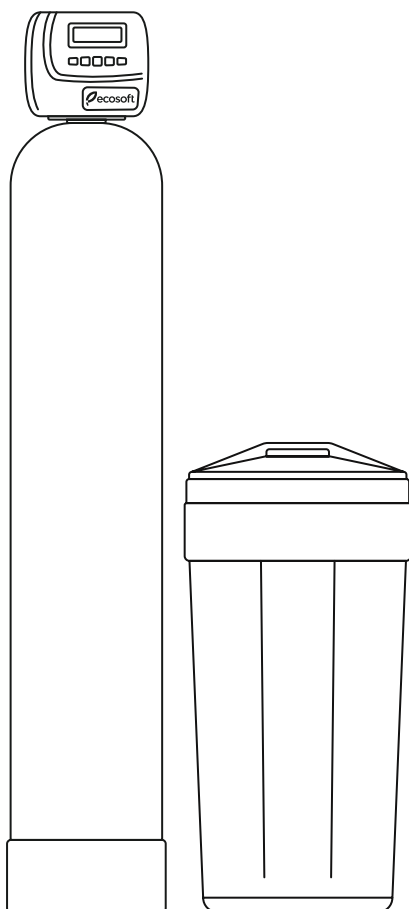

CONTENTS

| | | |
|----|--------------------|----|
| 1 | Purpose | 3 |
| 2 | Components | 7 |
| 3 | Installation | 9 |
| 4 | Programming | 22 |
| 5 | Maintenance | 29 |
| 6 | Precautions | 29 |
| 7 | Storage conditions | 29 |
| 8 | Troubleshooting | 30 |
| 9 | Specifications | 32 |
| 10 | Warranty | 39 |
| 11 | Installation sheet | 40 |



This appliance is not intended for use by persons (including children) with reduced physical, sensory or mental capabilities, or lack of experience and knowledge, unless they have been given supervision or instruction concerning use of the appliance by a person responsible for their safety. Children should be supervised to ensure that they do not play with the appliance.

1. PURPOSE

1.1. Overview

Ecosoft media systems are automatic water treatment appliances using bed filtration to remove impurities. Ecosoft filters consist of the following main parts:

- pressure vessel made of fiberglass reinforced plastic
- automatic control valve mounted on the pressure vessel
- riser pipe, top and bottom distributors
- filter media
- (FK and FU systems only) brine tank with brine system

Ecosoft filters are used for treatment of household water, steam boiler and heating circuit feed water, and other commercial and industrial water treatment processes. Different series of Ecosoft filters are intended for removal of different types of impurities.

Pressure vessel size determines the quantity of filter media, flow capacity, and volume capacity of the filter. When water passes through the filter, the filter bed accumulates impurities that it works to remove. After using up the volume capacity of water, the material's holding capacity or exchange capacity becomes exhausted and the filter stops removing more impurities (or the pressure drop builds up to critical value). At this point, the filter must be rinsed or brine regenerated to restore its capacity. Volume capacity depends on the quantity of filter media and composition of raw water.

When exhausted, non brine regenerated filters are backwashed and then forward rinsed to release the accumulated impurities. Brine regenerated filters undergo backwash, then rinse with brine from the brine tank to release hardness ions from ion exchange sites, then forward rinse and brine tank fill.

Ecosoft filters use the following naming conventions:

| | |
|-------------|--|
| FU | Type of system: FU, FK, FP, FPA or FPC (described in the following section) |
| 1252 | Pressure tank size: '12' inch diameter, '52' inch tank height (first two digits indicate the diameter, second two digits indicate the height) |
| CE | Control valve type: CE, CI, CT or DV (described in the following sections) |
| Twin | Special types of systems (Cabinet, Twin, Duplex etc) |

1.2. Ecosoft FK advanced water softeners with Ecomix®

Well water often contains calcium, magnesium, iron, manganese, ammonia and natural organic matter that would normally require multi-step water treatment to bring down all the constituents to permitted concentrations. Ecosoft developed a proprietary solution for removing all these impurities in one step and a single filter. Ecomix® advanced softening media effectively treats problem water even when complicated with non-neutral pH, high TDS, and other noxious impurities.

Regeneration requires sodium chloride brine and exactly same equipment as in a regular softener. Ecomix® is a complex media with ion exchange and adsorptive components that function in synergy. After loading and backwashing, Ecomix bed stratifies in the right succession of layers ready to operate.

1.3. Ecosoft FU ion exchange softeners resin with Dowex® resin

Water hardness accounts for the largest costs among all water quality issues incurred by households, business, and public sector. Some of the symptoms of excessive water hardness are limescale deposition inside water pipes and appliances, high detergent demand, poor soap lathering, compromised plumbing fixture appearance, overuse of electric power by water heating appliances, poor skin and hair condition.

Water hardness arises chiefly from calcium and magnesium dissolved in water. Ion exchange softening is one of the simplest ways to reduce water hardness. Ion exchange resins work by attracting and retaining ions of hardness metals in the polymer structure. For balance, they release equivalent quantity of sodium ions.

When ion exchange capacity of the resin becomes depleted, the resin must be regenerated to restore the capacity. During regeneration, table salt brine seeps slowly through the bed, allowing sodium ions to displace and flush out ions of hardness.

Ecosoft water softeners use Dowex® ion exchange resin.

1.4. Multiple unit systems

In large and/or critical applications such as boiler feed water treatment, public water services, manufacturing etc, softening units are usually required to operate uninterruptedly without regeneration stops. In these cases, Ecosoft multiple unit systems are used.

Duplex systems comprise two softeners operating in parallel, locked out from simultaneous regeneration and equipped with auxiliary motorized No Hard Water Bypass valves to

prevent hard water bypass during regeneration. Duplex systems can only be assembled with CI and CE control valves. In a Duplex system, only one softener can regenerate at any time. The other will remain online at least until the regenerating softener goes back in service. When no softener is regenerating, both softeners will be in service providing two times the flow rate.

Twin systems comprise two softeners with a single Twin type control valve, or alternatively, two regular control valves and a Motorized Alternating Valve. In Twin systems, only one softener is in service at any time, the other is regenerating or in standby. Twin systems are assembled with a single brine tank for both softeners.

Triplex and larger multiple unit systems are used to provide uninterrupted water supply when widely variable water demand is allowed for. Triplex systems are less water intensive and can be programmed to different modes of unit activation. E.g., more softeners can be put to service when water demand increases and vice versa. Regeneration will happen during set time of the day. Triplex systems comprise three separate softeners equipped with auxiliary motorized No Hard Water Bypass valves and a Clack multisystem controller.

Twin systems comprise two softeners with a single Twin type control valve, or alternatively, two regular control valves and a Motorized Alternating Valve. In Twin systems, only one softener is in service at any time, the other is regenerating or in standby. Twin systems are assembled with a single brine tank for both softeners.

In the same way, larger multisystems with up to 6 softeners can be built using Clack multisystem controller.

1.5. Ecosoft FPA granular activated carbon filters

Ecosoft FPA systems come with Filtrasorb® macroporous granular activated carbon. Filtrasorb has high capacity and good hydraulic properties. Ecosoft FPA are timer-regenerated backwash-only filters.

Filtrasorb® is used for removing chlorine and chlorine compounds, natural organic matter, petroleum products, pesticides, and other pollutants. It also removes objectionable color, tastes, and odors.

1.6. Ecosoft FPC catalytic carbon filters

Centaur® is a granular activated carbon with catalytic properties used for improving color, taste, and odor of well water. Centaur® efficiency relies on its capacity to catalyze oxidation

of hydrogen sulfide and adsorb oxidation products. It also removes small quantities of iron and organic impurities.

In order to remove hydrogen sulfide and iron, Centaur requires that enough dissolved oxygen be present in water and a pH 7 or above. In some cases, raw water may need corrective treatment to meet above requirement. It is possible to substitute oxygen with injected oxidizers such as sodium hypochlorite, if necessary.

Ecosoft FPC are timer-regenerated backwash-only filters.

1.7. Ecosoft FP particle filters

Filter Ag® is a granular media used for reduction of suspended solids by removing particulate matter. The media consists of irregularly shaped grains that trap and hold particles by straining and adhesion. Common applications of Ecosoft FP systems include reducing water turbidity, removal of oxidized iron floc in deironing systems, removal of sand, silt and other. Ecosoft FP are timer-regenerated backwash-only filters.

For more information about Ecosoft water treatment systems, please see Ecosoft.com website.

2. COMPONENTS



Ecosoft media system

(brine tank is not part of FP, FPA and FPC systems)

Fiberglass reinforced plastic tank is the cylinder shaped plastic vessel with the filter media. Control valve is mounted on the threaded top opening. Riser pipe runs down to the bottom of the tank inside the pressure vessel, transporting water out of the filter during service and into the filter during backwash. Bottom distributor is attached to its end to spread flow of water uniformly and screen against fine particles.

Brine regenerable systems (FU and FK) include a **brine tank** – a plastic container with salt pellets where the brine is stored then drawn from during regeneration.

Control valve.

CE, CI, and CT type control valves use a plunger piston mechanism to route influent water accordingly to the current cycle of operation. DV valves use a rotary disk mechanism.

CE, CI and DV control valves for softening systems (FU and FK series) have 5 cycles; non-brine regenerable filters have 3 cycle CT control valves. The cycles are as follows:

1. in service mode, inlet water is sent through the filter bed to the purified water outlet;
2. during backwash, the control valve sends inlet water across the filter bed in the upflow direction to fluff it up and release trapped impurities to drain outlet;
3. during fast rinse, inlet water is sent through filter bed downflow and then to drain outlet;
4. (CE, CI, and DV only) during brine regeneration, inlet water is sent through brine injection system to suction brine from brine tank and slowly displace it across filter bed to drain outlet;
5. (CE, CI, and DV only) during brine tank refill, inlet water is sent through the filter bed, softened effluent refills the brine tank.

| Control valve type | Operating cycles | Meter and brine system | Special connectivity | Special firmware functionality |
|--------------------|------------------|------------------------|--|--|
| CE; Twin | 5 | Yes | <ul style="list-style-type: none"> • 2 motorized valves • dP switch • NO/NC 12 VDC wet contact • Twin interconnect | <ul style="list-style-type: none"> • 63 day history/diagnostics • 4 display languages • Selectable physical units |
| CI | 5 | Yes | <ul style="list-style-type: none"> • 1 motorized valve • dP switch • Twin interconnect | <ul style="list-style-type: none"> • 63 day history/diagnostics |
| CT | 3 | — | <ul style="list-style-type: none"> • dP switch | |
| DV | 5 | Yes | — | <ul style="list-style-type: none"> • 63 day history/diagnostics |

For more information about your control valve, please refer to control valve manual.

Filter media removes impurities from water. Rate of removal depends on the flow rate of water going through the bed of media. Efficient purification requires that the flow rate is within specified range (not too high or too low). Recommended range of flow rates per each type of filter is listed in specifications in the end of this manual.

3. INSTALLATION

- Installation area must meet all relevant building code. Water and power supply, and ambient conditions must meet Specification requirements of this manual.
- Observe all local plumbing and electrical code when connecting system to utilities
- Install check valve when connecting the filter to water mains. Install second check valve after the system to prevent back flow.
- Particles such as sand, scale or rust can damage the control valve. Install a point-of-entry sediment filter.
- Equip the system with sampling taps and pressure gauges as shown on drawings. It will help in case any maintenance or troubleshooting is necessary.
- Install a vacuum relief valve as shown if there is a booster pump downstream of Ecosoft filters. The FRP tanks may implode if subjected to negative pressure.
- If your system does not include bypass valve assembly, run a bypass pipeline along the entire system. This may be necessary for diagnostics and maintenance.

3.1. Procedure for installing an FU, FK, FPA, FPC, or FP system

1. Install FRP tank on firm level surface capable of supporting its weight. Put riser pipe with bottom distributor down in the pressure tank. Ensure that top end of riser pipe is level with the top opening of FRP tank (within ± 5 mm). It is advisable to fill the tank with water to about $\frac{1}{3}$ its height if installing an FP, FPA or FPC system.
 2. Put a plug or cap on the top end of the riser pipe to prevent getting any media inside the pipe. Pour the media in the tank using the funnel. When loading the tank, keep riser pipe vertical. If the pipe tilts, restore it to straight vertical direction. When finished, rinse the thread of tank opening with water to remove any grains of media stuck in the groove.
 3. Lock the top distributor in circular slot at the bottom of the control valve's shank. Mate the top distributor with top end of riser pipe, then screw control valve in the tank opening.
 4. Connect drain pipe to the male threaded drain outlet of the control valve. Run the drain pipe to floor drain or gravity drain pipe socket. Secure the drain pipe end above the receiving fixture with at least 1" air gap.
 5. If installing an FU or FK system, place the brine tank next to the FRP tank. Install flexible tube in the control valve's brine inlet and run it to the brine tank. Remove tank lid and brine well cap, pull the end of the tube inside and connect it to the brine valve, then re-assemble in reverse order. Fill the brine tank with salt pellets at least half full.
 6. Mount the pipe thread elbow adapters to the control valve's In and Out ports and tighten the coupling nuts. Do not put any mechanical load on fittings or use them to support pipes.
- Connect the system to water supply and downstream pipework without turning on the water supply. Do not confuse In and Out ports. They are embossed with direction arrows.
7. Remove the front panel by pulling the locking tabs on the left and right side. Run the power cord through the cord guide in the control valve's backplate and connect it to 12 VAC socket on the circuit board. Plug the power supply in the mains to power up the system.
 8. Start manual regeneration of the system. Scroll regeneration to backwash if it isn't the 1st step of the sequence. When the control valve starts the backwash, turn on mains water supply slightly at first. Air will be displaced from the system via drain line while the pressure tank is being filled with water. When the tank is full, water will start flowing down the drain line. At this point, fully open mains water supply. Carefully inspect the system for leaks.

Let the system complete regeneration, then perform one more manual regeneration.

3.2. Procedure for installing an FU Cabinet or FK Cabinet system

If your cabinet was delivered pre-loaded with resin, place the cabinet in the installation spot, fill salt compartment with salt pellets, and then only carry out steps 5...8 of the procedure, skipping steps 1...4. If the resin was shipped in bag, then carry out all of the following steps.

1. Disconnect the flexible tube from brine inlet of the control valve. Unmount the valve by screwing it counterclockwise.
2. Put a plug or cap on the top end of the riser pipe to prevent getting any media inside the pipe. Pour the media in the tank using the funnel. When loading the tank, keep riser pipe vertical. If the pipe tilts, restore it to straight vertical direction. When finished, rinse the thread of tank opening with water to remove any beads of media stuck in the groove.
3. Mate the top distributor with the top end of riser pipe, then screw control valve in the tank opening. Connect the free end of brine tube back to the brine inlet of the control valve.
4. Place the cabinet in the installation spot. Open top lid and fill the salt compartment with softener salt pellets at least half full.
5. Connect drain pipe to the male threaded drain outlet of the control valve. Run the drain pipe to floor drain or gravity drain pipe socket. Secure the drain pipe end above the receiving fixture with at least 1" air gap.

6. Mount the pipe thread elbow adapters to the control valve's In and Out ports and tighten the coupling nuts. Do not put any mechanical load on fittings or use them to support pipes.

Connect the system to water supply and downstream pipework without turning on the water supply. Do not confuse In and Out ports. They are embossed with direction arrows.

7. Remove the front panel by pulling the locking tabs on the left and right side. Run the power cord through the cord guide in the control valve's backplate and connect it to 12 VAC socket on the circuit board. Plug the power supply in the mains to power up the system.

8. Start manual regeneration of the system. Scroll regeneration to backwash if it isn't the 1st step of the sequence. When the control valve starts the backwash, turn on mains water supply slightly at first. Air will be displaced from the system via drain line while the pressure tank is being filled with water. When the tank is full, water will start flowing down the drain line. At this point, fully open mains water supply. Carefully inspect the system for leaks.

Let the system complete regeneration, then perform one more manual regeneration.

3.3. Procedure for installing an FU Twin or FK Twin systems

FU Twin and FK Twin systems are equipped with CE Twin control valve. The valve has two additional side ports for connecting to the twin tank. Twin systems provide uninterrupted treated water supply without falling back on raw water when the system is regenerating.

1. Install both FRP tanks on firm level surface capable of supporting their weight. Put riser pipes with bottom distributors down in each pressure tank. Ensure that top ends of riser pipe are level with the top openings of the FRP tanks (within ± 5 mm).
2. Put a plug or cap on the top ends of the riser pipes to prevent getting any media inside the pipes. Pour the resin in both tanks using the funnel. When loading each tank, keep riser pipe vertical. If the pipe tilts, restore it to straight vertical direction. When finished, rinse the threads of tank openings with water to remove any beads of media stuck in the grooves.
3. Lock the top distributor in circular slot at the bottom of the control valve's shank. Install control valve on the lead tank. Mate the distributor with top end of riser pipe, then screw the control valve in the tank opening. Rotate the tank if necessary so that the control valve's side ports face the second tank. Attach second top distributor to the In-out head and screw the head on the second tank. Use the two interconnectors to connect In-out head to the control valve. Fix the coupling nuts snugly.
4. Connect drain pipe to the male threaded drain outlet of the control valve. Run the drain pipe to floor drain or gravity drain pipe socket. Secure the drain pipe end above the receiving fixture with at least 1" air gap.
5. Place the brine tank beside the two FRP tanks. Install flexible tube in the control valve's brine inlet and run it to the brine tank. Remove tank lid and brine well cap, pull the end of the tube inside and connect it to the brine valve, then re-assemble in reverse order. Fill the brine tank with salt pellets at least half full.
6. Mount the pipe thread elbow adapters to the control valve's In and Out ports and tighten the coupling nuts. Do not put any mechanical load on fittings or use them to support pipes.

Connect the system to water supply and downstream pipework without turning on the water supply. Do not confuse In and Out ports. They are embossed with direction arrows.

7. Remove the front panel by pulling the locking tabs on the left and right side. Run the power cord through the cord guide in the control valve's backplate and connect it to 12 VAC socket on the circuit board. Plug the power supply in the mains to power up the system.

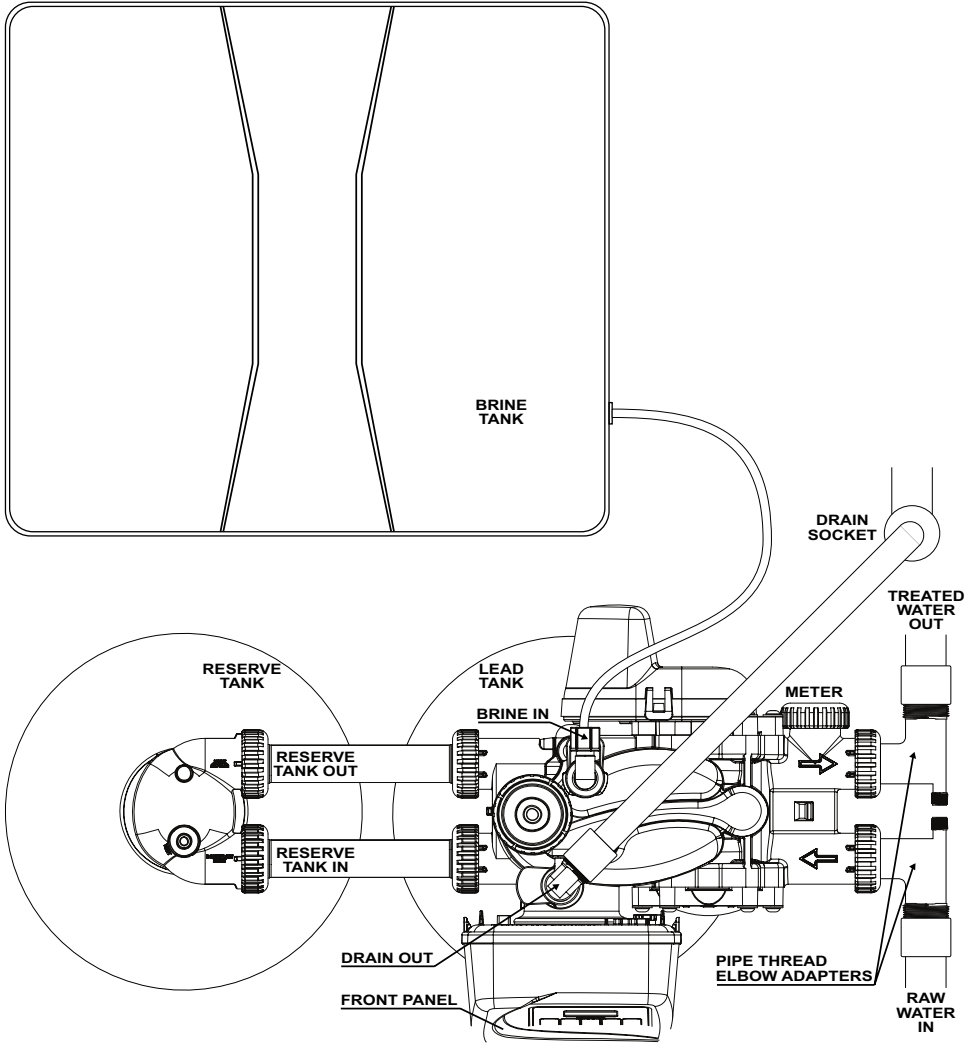

Ecosoft FU Twin/FK Twin piping connections top view

Shown without meter cable and power adapter cable.

8. Start manual regeneration of the system. Scroll regeneration to backwash if it isn't the 1st step of the sequence. When the control valve starts the backwash, turn on mains water supply slightly at first. Air will be displaced from the system via drain line while the tank is being filled with water. When the tank is full, water will start flowing down the drain line.

At this point, scroll through the rest of the regeneration sequence to end regeneration. Then start one more manual regeneration and scroll to backwash if it isn't the 1st step. Wait until all air is displaced from the second tank. Then scroll through the rest of regeneration sequence to end regeneration.

Fully open mains water supply. Carefully inspect the system for leaks. Manually initiate two more complete regenerations, one after another.

3.4. Procedure for installing a DFU Twin or DFK Twin systems

DFU Twin and DFK Twin systems are equipped with two CE control valves, a three-way Motorized Alternating Valve, and a communication cable for connecting the control valves. The three-way MAV routes water from the filter that is currently in service to the outlet, while keeping the reserve filter shut off. Lead filter's control valve actuates the MAV and controls the reserve filter.

Twin systems provide uninterrupted treated water supply without falling back on raw water when the system is regenerating.

1. Install both FRP tanks on firm level surface capable of supporting their weight. Put riser pipes with bottom distributors down in each pressure tank. Ensure that top ends of riser pipe are level with the top openings of the FRP tanks (within ± 5 mm).
2. Put plugs or caps on the top ends of the riser pipes to prevent getting any media inside the pipes. Pour the resin in both tanks using the funnel. When loading each tank, keep riser pipe vertical. If the pipe tilts, restore it to straight vertical direction. When finished, rinse the threads of tank openings with water to remove any beads of media stuck in the grooves.
3. Lock the top distributor in circular slot at the bottom of the control valve's shank. Install control valve on the lead tank. Mate the distributor with top end of riser pipe, then screw the control valve on. Install the second control valve on the reserve filter tank in the same way.
4. Connect drain pipe to the male threaded drain outlet of each control valve. Run the drain pipes to floor drain or gravity drain pipe socket. Secure the drain pipe end above the receiving fixture with at least 1" air gap.

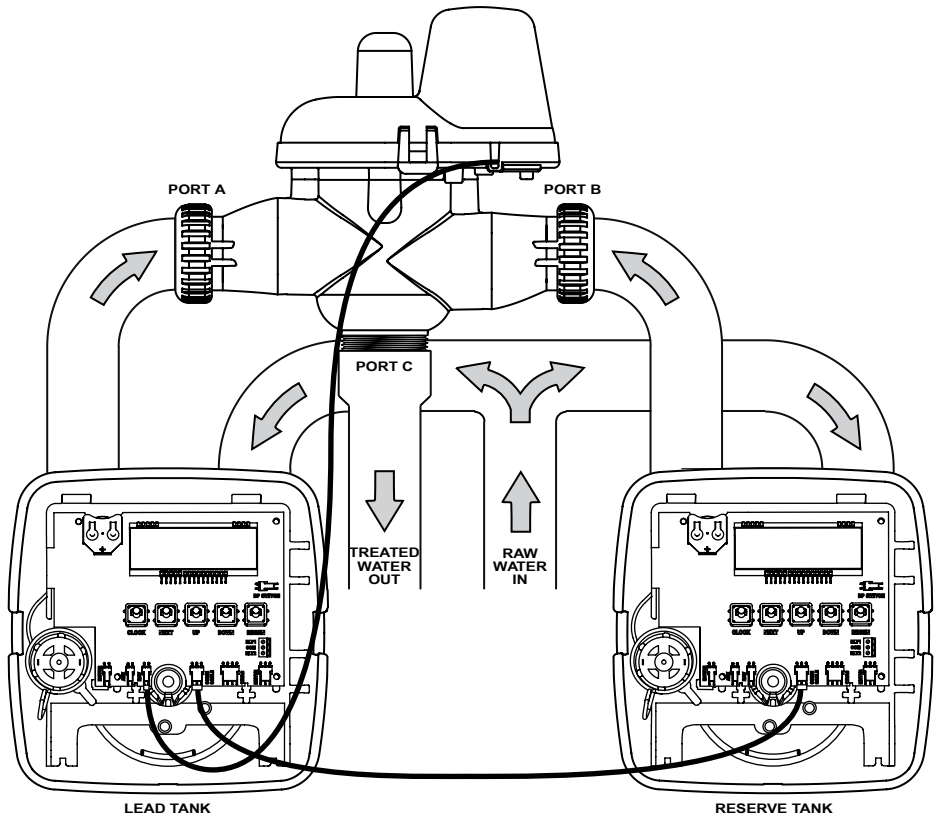

Ecosoft DFU Twin/DFK Twin system setup

MOTOR, **12VAC**, and **METER** cords are not shown but must be plugged in for proper functioning of each filter. Both control valves must be programmed for Twin operation as provided in the following section.

- Place the brine tank beside the FRP tanks. Install flexible tube in both control valves' brine inlets, join them with a tee connector and run a third piece of flexible tube from the tee to the brine tank. Remove tank lid and brine well cap, pull the end of the tube inside and connect it to the brine valve, then re-assemble in reverse order. Fill the brine tank with salt.
- Mount the pipe thread elbow adapters to the control valve's In and Out ports and tighten the coupling nuts. Do not put any mechanical load on fittings or use them to support pipes.

Connect both filters to water supply via In ports without turning on the water supply. Connect the Out ports to MAV's A and B ports. Then connect port C of the MAV to the downstream pipework. Do not confuse In and Out ports. They are embossed with direction arrows.

7. Remove the front panel of each control valve by pulling the locking tabs on the left and right side. Run the power cord through cord guide in each control valve's backplate and connect it to the 12 VAC socket on the circuit board. Connect MAV cord to the lead filter's MAV socket. Connect the lead tank's circuit board to the reserve tank's circuit board with the 3-wire cable by plugging it in the COMM CABLE sockets in each circuit board. Make sure all external cables are routed through the guides in control valve backplates, so the front panel can be put back on. Plug both power supplies in the mains to power up the system.

8. Enter programming menu and setup both control valves for Twin operation (see programming instructions in the next section).

9. Start manual regeneration of the lead filter by holding REGEN button for 5 seconds. Scroll regeneration to backwash if it isn't the 1st step of the sequence. When the control valve starts the backwash, turn on mains water supply slightly at first. Air will be displaced from the system via drain line while the pressure tank is being filled with water. When the tank is full, water will start flowing down the drain line. At this point, scroll through the rest of the regeneration sequence to end regeneration.

Then start one more manual regeneration (by holding REGEN button of the lead filter) and scroll to backwash if it isn't the 1st step. Wait until all air is displaced from the second tank. Then scroll through the rest of regeneration sequence to end regeneration.

Fully open mains water supply. Carefully inspect the system for leaks. Manually initiate two more complete regenerations, one after another.

3.5. Procedure for installing a DFU Duplex or DFK Duplex systems

DFU Duplex and DFK Duplex systems are equipped with two CE control valves, two No Hard Water Bypass Valves, and two microswitches with linking cables. The microswitches link each control valve to the other control valve's microswitch socket. This prevents both filters regenerating simultaneously – if one of the filters is regenerating, the other will not regenerate until the former finishes. No Hard Water Bypass Valves prevent raw water from being drawn when any of the filters regenerate.

Duplex systems provide uninterrupted treated water supply with the peak flow capacity of both filters online, low flow capacity of one filter online one offline for regeneration.

1. Install both FRP tanks on firm level surface capable of supporting their weight. Put riser pipes with bottom distributors down in each pressure tank. Ensure that top ends of riser pipe are level with the top openings of the FRP tanks (within ± 5 mm).

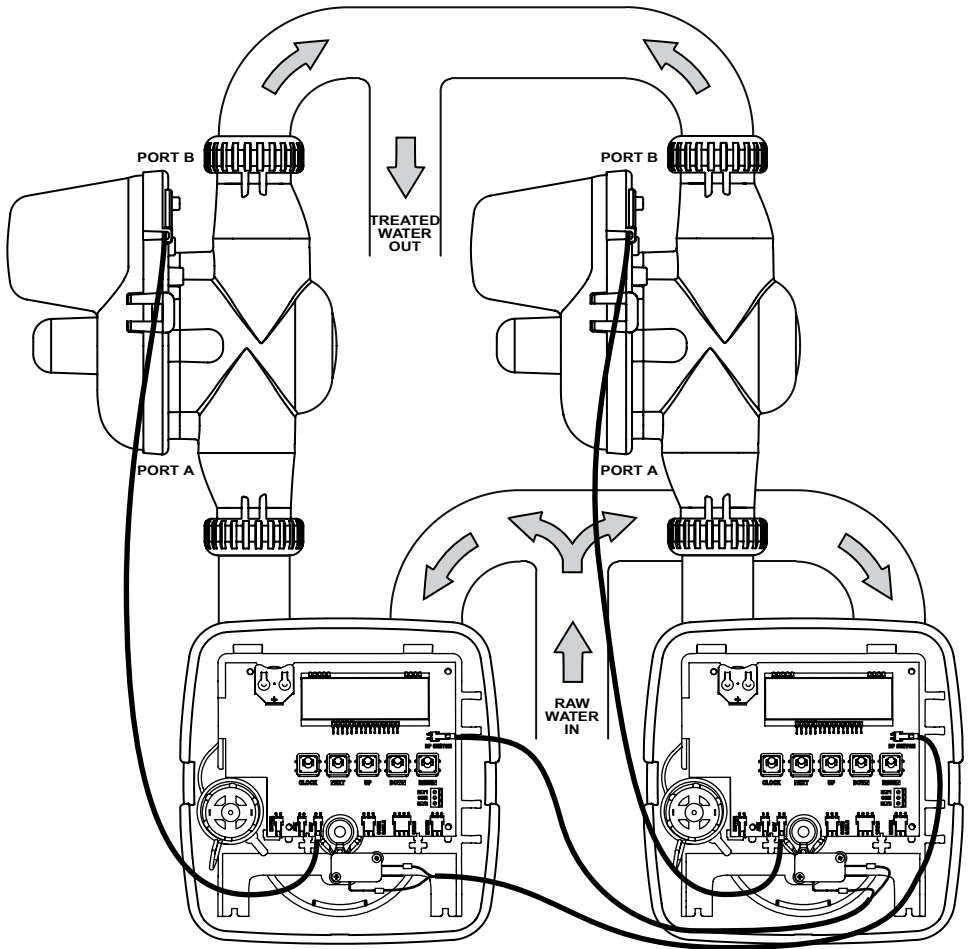

Ecosoft DFU Duplex/DFK Duplex system setup

MOTOR, **12VAC**, and **METER** cords are not shown but must be plugged in for proper functioning of each filter.

Two microswitches must be installed on the control valves as shown on the drawing. Each microswitch must be connected to the other control valve's **DP_SWITCH** socket.

Both control valves must be programmed for Duplex operation as provided in the following section.

2. Put plugs or caps on the top ends of the riser pipes to prevent getting any media inside the pipes. Pour the resin in both tanks using the funnel. When loading each tank, keep riser pipe vertical. If the pipe tilts, restore it to straight vertical direction. When finished, rinse the threads of tank openings with water to remove any beads of media stuck in the grooves.
3. Lock top distributor in circular slot at the bottom of the control valve's shank. Install control valve on the lead tank. Mate the distributor with top end of riser pipe, then screw the control valve on. Install the second control valve on the second filter tank in the same way.
4. Connect drain pipe to the male threaded drain outlet of each control valve. Run the drain pipes to floor drain or gravity drain pipe socket. Secure the drain pipe end above the receiving fixture with at least 1" air gap.
5. Place the brine tanks beside the FRP tanks. Install flexible tube in each control valve's brine inlet and run it to its respective brine tank. Remove tank lid and brine well cap, pull the end of the tube inside and connect it to the brine valve, then re-assemble in reverse order. Fill the brine tanks with salt pellets at least half full.
6. Install the No Hard Water Bypass Valves (NHWBPs) on both control valves' Out port using WS1 Vertical Adapters. Connect the Out ports to NHWBPs' A ports. Then connect B ports of the NHWBPs to the downstream pipework.

Connect the control valves' In ports to the water supply line without turning on the water supply. Use pipe thread elbow adapters for connecting the control valves and the NHWBP's to the main pipework.

Do not confuse In and Out ports. They are embossed with direction arrows. Do not put any mechanical load on fittings or use them to support pipes.

7. Remove the front panel of each control valve by pulling the locking tabs on the left and right side. Run the power cord through the cord guide in each control valve's backplate and connect it to the 12 VAC socket on the circuit board.

Connect the NHWBP cord to control valve board's MAV socket. Install the microswitches in each control valve as shown in picture.

Route the microswitch wire through guide in the backplate and connect to the microswitch. Route the other end of the wire through the guide in the other control valve and connect to DP Switch socket. Repeat for the other valve.

Make sure all external cables are routed through guides in control valve backplates, so the front panel can be put back on. Plug both power supplies in mains to power up the system.

8. Enter programming menu and setup both control valves for Duplex operation (see programming instructions in the next section).

9. Start manual regeneration of the first filter by holding REGEN button for 5 seconds. Scroll regeneration to backwash if it isn't the 1st step of the sequence. When the control valve starts the backwash, turn on mains water supply slightly at first. Air will be displaced from the system via drain line while the pressure tank is being filled with water. When the tank is full, water will start flowing down the drain line.

At this point, scroll through the rest of the regeneration sequence to end regeneration.

Then start manual regeneration of the second filter and scroll to backwash if it isn't the 1st step. Wait until all air is displaced from the second tank. Then scroll through the rest of regeneration sequence to end regeneration.

Fully open mains water supply. Carefully inspect the system for leaks. Manually initiate two more complete regenerations of each filter, one after the other.

3.6. FK, FU, FPA, or FPC installation diagram

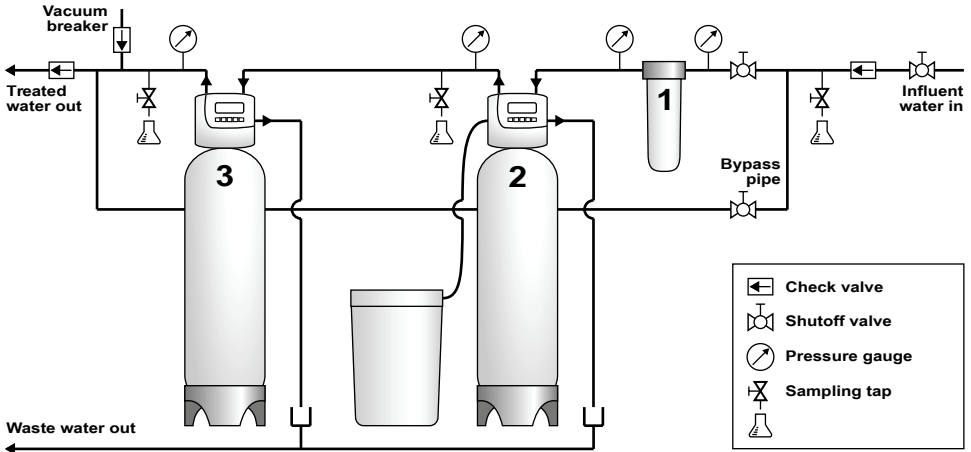

1. 100 µm sediment filter
2. FK or FU softener
3. FPA or FPC carbon filter

3.7. FK or FU Twin installation diagram

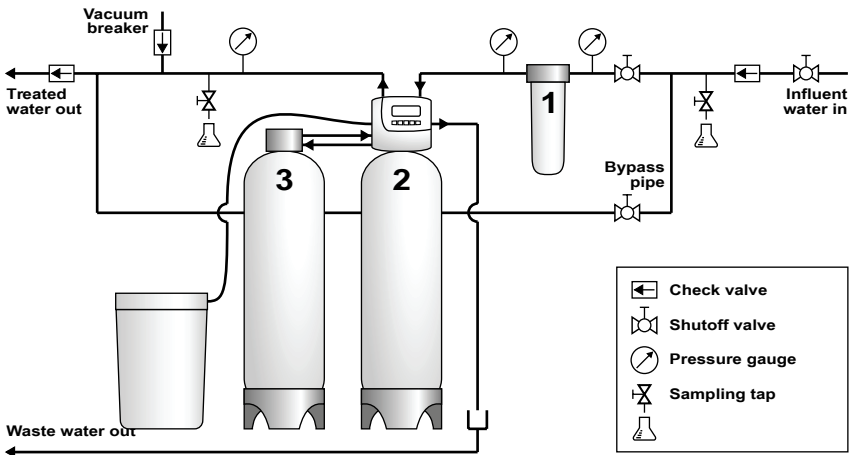

1. 100 µm sediment filter
2. FK or FU Twin softener (lead filter)
3. FK or FU Twin softener (reserve filter)

3.8. DFK or DFU Twin installation diagram

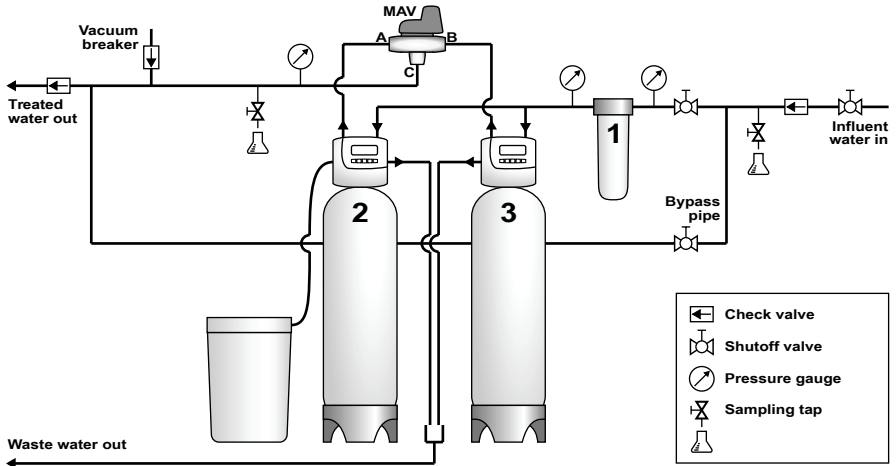

1. 100 µm sediment filter
2. DFK or DFU Twin softener (lead filter)
3. DFK or DFU Twin softener (reserve filter)

3.9. DFK or DFU Duplex installation diagram

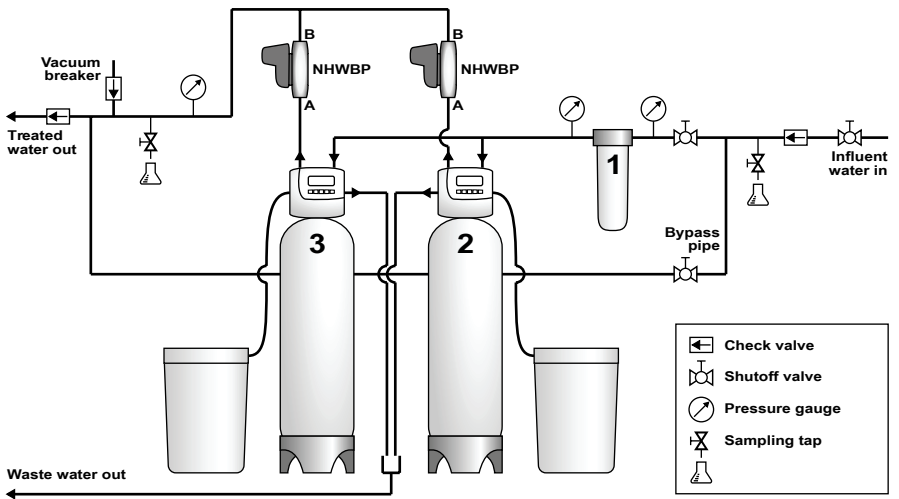

1. 100 µm sediment filter
2. DFK or DFU Duplex softener (lead filter)
3. DFK or DFU Duplex softener (reserve filter)

4. PROGRAMMING

4.1. CE, CI, CE Twin control valve setup (FK, FU, FK Twin, FU Twin systems)

After installing and powering up an Ecosoft FU or FK system, enter display language, water hardness, current time, and regeneration options in the **Installer** menu of control valve. Use ▲ and ▼ buttons to change setting; NEXT button to save and go to next step; CLOCK to save and exit menu; REGEN to move back one step;

To proceed, hold NEXT and ▲ buttons simultaneously for 3 seconds.

Language menu will show up. Select display language. This menu entry is only accessible in CE valves.

Enter hardness of influent water. Milliequivalent per liter is the default hardness unit.

Refer to control valve manual to change to a different unit (only accessible in CE valves).

If the control valve is equipped with internal hard water mixing valve, there will be Service Hardness entry (hardness of the mixed product water) after influent water hardness.

Set Day Override (maximum number of days in service, after which control valve will carry out preventive regeneration). 14 days is recommended.

Set the preferred time of delayed regeneration, hours then minutes (factory set to 2 AM).

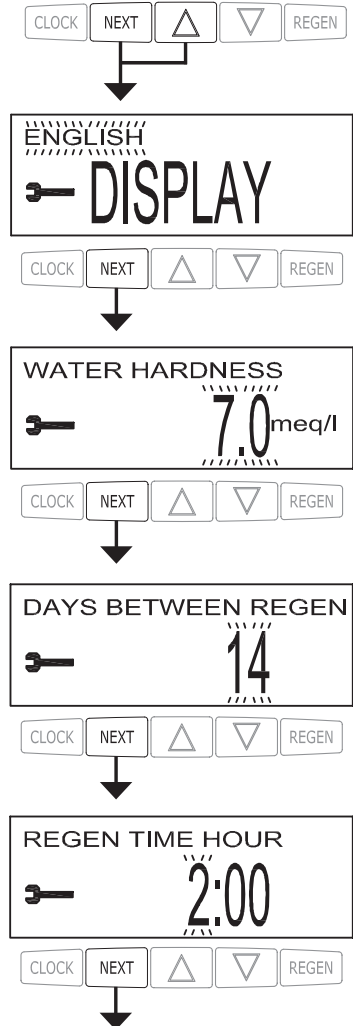

Choose whether to Turn off display backlight 5 minutes after last keypad input event (only accessible in CE valves). Pressing NEXT will exit the menu.



NORMAL MODE

Enter current time setting by pressing CLOCK.



Set current time, hours then minutes.



NORMAL MODE

4.2. CE, CI control valve setup for Twin systems (DFK Twin, DFU Twin systems)

After installation and powering up of Ecosoft DFK Twin or DFU Twin system, enter **Configuration Setup** menu to make the necessary adjustments in both control valves.

To proceed, hold NEXT and ▼ buttons for a few seconds until MODE screen shows up. Then, hold NEXT and ▼ buttons again for a few seconds, until VALVE TYPE screen shows up.

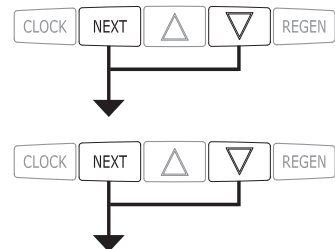

When VALVE TYPE screen appears, press NEXT to go to the VALVE 1 screen.

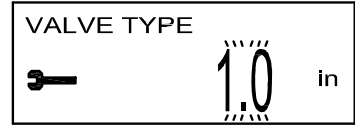

Select VALVE A in the lead filter's control valve that is connected to the Motorized Alternating Valve. Select VALVE B in the reserve filter's control valve.



NORMAL MODE

Then open **System Setup** menu by holding NEXT and ▼ buttons for a few seconds until MODE screen shows up.

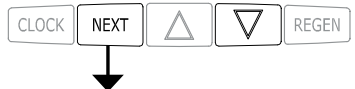
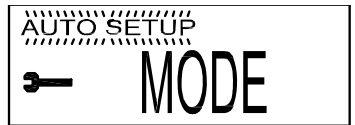
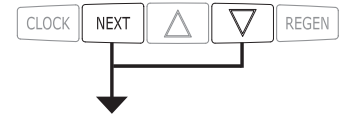

Scroll forward until regeneration TYPE screen is displayed.



NORMAL MODE

Select IMMEDIATE REGEN option in both control valves (lead filter and reserve filter).

Press CLOCK to save and exit menu.

Then carry out setup procedure 4.1 with both control valves, with the exception that Day Override (day between regen) must be set to OFF.

4.3. CE, CI control valve setup for Duplex systems (DFK Duplex, DFU Duplex systems)

After installing and powering up an Ecosoft DFK Twin or DFU Twin system, enter **Configuration Setup** menu to make the necessary adjustments in both control valves.

To proceed, hold NEXT and ▼ buttons for a few seconds until MODE screen shows up. Then, hold NEXT and ▼ buttons again for a few seconds, until VALVE TYPE screen shows up.

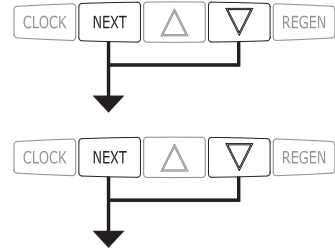

When VALVE TYPE screen appears, press NEXT to go to the VALVE 1 screen.

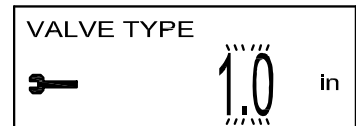

Select VALVE 1 — NHWBP (No Hard Water Bypass Valve) in both control valves' menus.

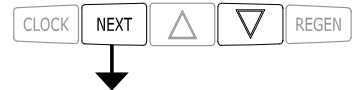

Select (or keep) OFF value in the VALVE 2 entry.
This entry is only accessible in CE valves.

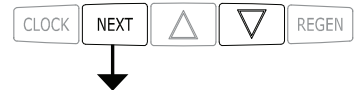

Set Auxiliary Input to HOLD REG in order to enable regeneration lockout when the other filter is regenerating. It reads HOLD in CI valves. Press CLOCK to save and exit or scroll through the rest of the menu without changing any entries.

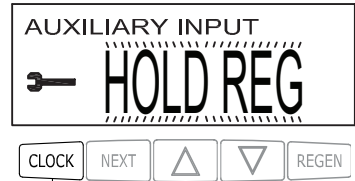

NORMAL MODE

Then open **System Setup** menu by holding NEXT and ▼ buttons for a few seconds until MODE screen shows up.

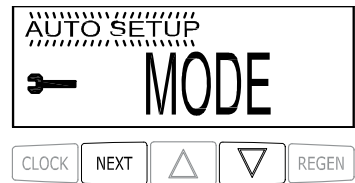

Scroll forward until regeneration TYPE screen is displayed.

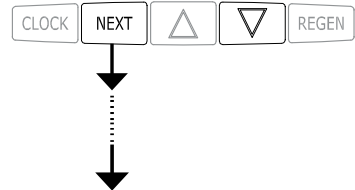

NORMAL MODE

Select IMMEDIATE REGEN option in both control valves.

Press CLOCK to save and exit menu.

Carry out setup procedure 4.1 with both control valves, with the exception that Day Override (day between regen) must be set to OFF.

4.4. DV control valve setup
(FK and FU Cabinet systems)

After installing and powering up an Ecosoft FU Cab or FK Cab system, enter display language, water hardness, current time, and regeneration options in the **Installer** menu. Use ▲ and ▼ buttons to change settings; ↵ button to save and go to the next step;

To proceed, hold  and  buttons simultaneously for 3 seconds.

Enter hardness of influent water in ppm (parts per million CaCO₃).

If the control valve is equipped with internal hard water mixing valve, there will be Service Hardness entry (hardness of the mixed product water) after influent water hardness.

Set Day Override (maximum number of days in service, after which control valve will carry out preventive regeneration). 14 days is recommended.

Set the preferred time of delayed regeneration, hours then minutes (factory set to 2 AM).

Press  to exit the menu.

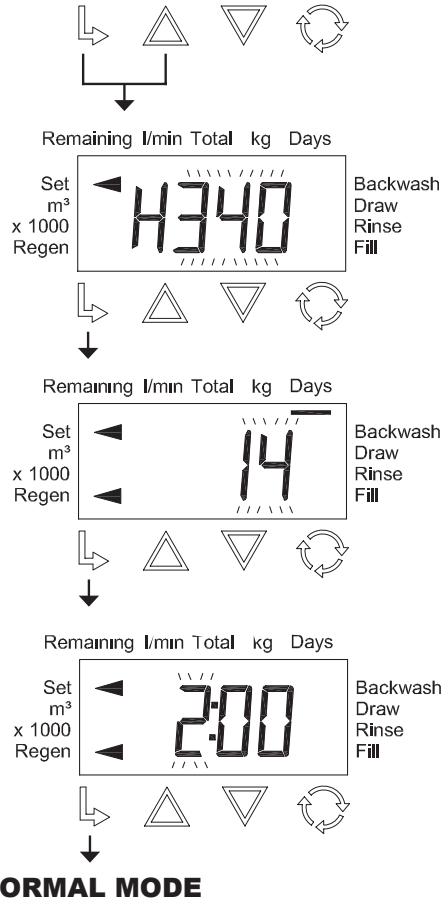

4.5. CT control valve setup

(FP, FPA, FPC systems)

After installing and powering up an Ecosoft FP, FPA, or FPC system, enter current time, and regeneration options in the **Installer** menu of control valve.

Use  and  buttons to change setting; **SET** button to save and go to next step.

To proceed, hold SET and  buttons for a few seconds until Regeneration time screen shows up.



Set the preferred time of regeneration, hours then minutes (factory set to 2 AM).



Set the current day of the week (Day 1 is Sunday, Day 2 is Monday and so on).



Enable or disable regeneration on Sunday night using ▲ or ▼ buttons. Regeneration on this day will be performed if arrow is displayed next to Regen sign on the display.



Press SET to save and step forward to Monday. Similarly, enable or disable regeneration on Monday.

Scroll over the days of the week and select days for system regeneration, then exit menu.

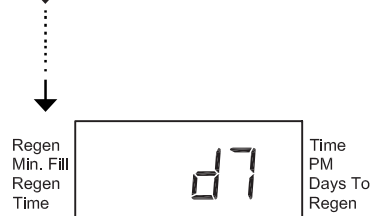

NORMAL MODE

Enter current time setting by pressing SET.



Set current time, hours then minutes. Then exit the menu.



For more information, see the control valve manual.

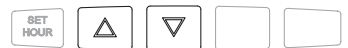

5. MAINTENANCE

Brine tank must always contain enough salt pellets. Salt level must always be above the water surface. Do not use any type of salt other than salt pellets for softener regeneration.

To avoid fouling of media during prolonged downtime without power and water supply, fill the FRP tank with brine as follows. Start manual regeneration, wait 20 minutes into the brine stage, then shut off water supply and scroll through the rest of regeneration cycles by pressing REGEN until the control valve flashes SOFTENING and then displays current time. Then, turn off the power of control valve. Also, perform regeneration when resuming service after prolonged downtime.

Check the equipment for any damage and inspect pipework for leaks every few weeks. Correct the control valve's time if it is off. Replace sediment pre-filter if pressure drop exceeds 1 bar (14 psi).

6. PRECAUTIONS

Turn off power and water supply and relieve pressure before doing any maintenance.

Do not subject the system to vibration, shock, or mechanical load.

Electrical board of the control valve must be protected from water/moisture during regular service and any maintenance.

Hardness metals, iron, sediment and other impurities may form deposits on the surfaces of the control valve, which can lead to failure. It is advised to carry out preventive maintenance at least two times a years if there is an elevated concentration of iron in the influent water, or at least once a year otherwise.

7. STORAGE

Only store indoors, vertically. Ambient conditions must meet the requirements listed for installation room conditions in the Specifications section.

8. TROUBLESHOOTING

| PROBLEM | CAUSE | CORRECTION |
|--|---|---|
| 1. Decreased service flow capacity. | Decreased supply water pressure. | Increase supply water pressure. |
| | Clogged filter bed. | See <i>paragraph 3</i> . |
| | Obstructed/clogged drain line. | Clean the drain line. |
| | Clogged control valve. | Inspect and clean the control valve. |
| | NHWBP/MAV failure (if used). | Inspect and repair the motorized valve. |
| 2. Decreased quality of treated water. | Faulty chemical analysis of water. | Perform one more test using freshly prepared reagents. |
| | Supply water chemistry has changed. | Make new check analysis and if changed contact your dealer. |
| | Bypass valve is set to bypass. | Turn bypass valve to operating position. |
| | Riser pipe or seals are damaged. | Take apart the filter, inspect and replace or lubricate pipe and seals if necessary |
| | Clogged filter bed. | See <i>paragraph 3</i> . |
| | Filter media loss. | See <i>paragraph 4</i> . |
| | Improper filter regeneration. | See <i>paragraph 6</i> . |
| | Leakage of raw water inside the control valve. | Take apart the control valve, inspect and replace or lubricate the seals if needed. |
| 3. Clogged filter bed. | Insufficient backwash flow rate. | Check backwash flow rate. If supply pressure is within the limits and the flow rate is insufficient, inspect and clean the drain line flow control or replace it if needed. |
| | Insufficient backwash stage. | Increase the duration of backwash stage. |
| | Clogged top distributor. | Clean the top distributor. |
| | Excessive backwash flow rate. | Measure backwash flow rate. If supply pressure is normal and the flow rate is exceeding, consider changing the drain line flow control. |
| 4. Filter media entrainment. | Filter media is entrained and discharged during backwash. | Replace the top distributor if needed. |
| | Filter media is entrained and discharged during service. | Replace the bottom distributor if needed. |

| PROBLEM | CAUSE | CORRECTION |
|---|---|--|
| 5. System will not regenerate. | No electric power. | Check power supply. |
| | No/insufficient salt in brine tank. | Check the amount of salt in brine tank and add salt if needed. |
| | Brine is not sucked in during regen., or not all brine is drawn. | <i>See paragraph 6.</i> |
| | Control valve is out of order or settings were changed. | Check the control valve and its settings (see the manual for the control valve). |
| | Brine tank is not refilled or is refilled with not enough water. | <i>See paragraph 7.</i> |
| 6. Brine will not draw during regeneration or not all brine will draw. | Low supply water pressure. | Check supply water pressure. |
| | Clogged injector or brine tube. | Clean brine injector and/or brine tube. |
| | Clogged basket or salt crystals on ball in air check valve. | Clean air check valve basket and/or ball. |
| | High pressure drop on the filter (control valve, distributors or filter media are clogged). | <i>See paragraphs 1 and 4.</i> |
| | Air is injected due to brine line not being airtight. | Check airtightness of the drain line. |
| | Control valve settings changed. | Increase brine stage duration. |
| 7. Brine tank is not refilled or refilled with less water than needed | Low supply water pressure. | Check supply water pressure. |
| | Clogged injector or brine tube. | Clean brine injector and/or brine tube. |
| | Stuck ball in the air check valve. | Clean the air check valve. |
| | Control valve settings changed. | Check the duration of brine tank refill and correct if necessary. |
| 8. Excess use of salt per regeneration | Control valve settings changed. | Decrease the amount of salt per regeneration in the control valve settings. |
| | Brine tank filled with excess water. | <i>See paragraph 9.</i> |
| 9. Brine tank is refilled with excess water | High main water pressure. | Check water pressure. Install pressure regulator if needed. |
| | Control valve settings changed. | Check the duration of brine tank refill and correct if necessary. |

9. SPECIFICATIONS

9.1. Ecosoft FK Ecomix® systems

Requirements and limitations

Installation room

| | |
|-----------------------|---|
| Ambient temperature | +5°C...+40°C |
| Relative humidity | ≤80% |
| Operating environment | indoor; free of corrosive vapors, airborne dust, and fibrous matter; sheltered from weather and direct sunlight |

Power supply

| | |
|-------------------|---------------------------|
| Electrical rating | 230 V, 50 Hz (EU adapter) |
| Power | 6 VA |

Water supply

| | |
|-------------------|---------------------|
| Pressure | 2-6 bar (30-90 psi) |
| Water temperature | +4°C...+30°C |
| Prefilter rating | 100 µm |

Maximum influent concentrations

| | |
|------------------------|---|
| Hardness | 750 mg/L CaCO ₃ (42 °dH; 45 gpg) |
| Iron | 15 mg/L |
| Manganese | 3 mg/L |
| Ammonia | 4 mg/L |
| Chemical oxygen demand | 20 mg/L O ₂ |
| Total dissolved solids | 4000 mg/L |

Model range

| Model | Overall dimensions ¹ , m (width x depth x height) | Nominal flow rate, m ³ /h | Quantity of media, L | Consumption of salt per regeneration, kg NaCl | Consumption of water per regeneration, m ³ | Minimum required flow capacity ² @ 2 bar, m ³ /h |
|--------------|---|--------------------------------------|----------------------|--|--|--|
| FK-0817 Cab | 0,25×0,45×0,65 | 0,5 | 8 | 0,8 | 0,15 | 0,5 |
| FK-0835 Cab | 0,25×0,45×1,15 | 0,8 | 18 | 1,8 | 0,2 | 0,5 |
| FK-1018 Cab | 0,35×0,55×0,7 | 0,8 | 12 | 1,2 | 0,15 | 0,8 |
| FK-1035 Cab | 0,35×0,55×1,15 | 1,2 | 25 | 2,5 | 0,3 | 0,8 |
| FK-1235 Cab | 0,35×0,55×1,15 | 1,2 | 25 | 2,5 | 0,3 | 1,0 |
| FK-1035 | 0,9×0,5×1,1 | 0,8 | 25 | 2,5 | 0,3 | 0,8 |
| FK-1054 | 1,0×0,6×1,6 | 1,2 | 37 | 3,7 | 0,4 | 0,8 |
| FK-1252 | 1,0×0,6×1,6 | 1,8 | 50 | 5,0 | 0,5 | 1,0 |
| FK-1354 | 1,0×0,6×1,6 | 2,1 | 62 | 6,2 | 0,6 | 1,2 |
| FK-1465 | 1,1×0,6×1,9 | 2,5 | 75 | 7,5 | 0,8 | 1,5 |
| FK-1665 | 1,1×0,6×1,9 | 3,3 | 100 | 10,0 | 1,0 | 2,0 |
| FK-1035 Twin | 1,4×0,5×1,1 | 0,8 | 50 | 2,5 | 0,3 | 0,8 |
| FK-1054 Twin | 1,5×0,6×1,6 | 1,2 | 74 | 3,7 | 0,4 | 0,8 |
| FK-1252 Twin | 1,5×0,6×1,6 | 1,8 | 100 | 5,0 | 0,5 | 1,0 |
| FK-1354 Twin | 1,6×0,6×1,6 | 2,1 | 124 | 6,2 | 0,6 | 1,2 |
| FK-1465 Twin | 1,7×0,6×1,9 | 2,5 | 150 | 7,5 | 0,8 | 1,5 |
| FK-1665 Twin | 1,8×0,6×1,9 | 3,3 | 200 | 10,0 | 1,0 | 2,0 |

¹ may vary depending on arrangement of pieces² supply water flow rate required for proper regeneration of system

9.2. Ecosoft FU softening systems

Requirements and limitations

Installation room

| | |
|-----------------------|---|
| Ambient temperature | +5°C...+40°C |
| Relative humidity | ≤80% |
| Operating environment | indoor; free of corrosive vapors, airborne dust, and fibrous matter; sheltered from weather and direct sunlight |

Power supply

| | |
|-------------------|---------------------------|
| Electrical rating | 230 V, 50 Hz (EU adapter) |
| Power | 6 VA |

Water supply

| | |
|-------------------|---------------------|
| Pressure | 2-6 bar (30-90 psi) |
| Water temperature | +4°C...+30°C |
| Prefilter rating | 100 µm |

Maximum influent concentrations

| | |
|-----------|---|
| Hardness | 750 mg/L CaCO ₃ (42 °dH; 45 gpg) |
| Iron | 0,2 mg/L |
| Manganese | 0,05 mg/L |

Model range

| Model | Overall dimensions ¹ , m (width × depth × height) | Nominal flow rate, m ³ /h | Quantity of media, L | Consumption of salt per regeneration, kg NaCl | Consumption of water per regeneration, m ³ | Minimum required flow capacity ² @ 2 bar, m ³ /h |
|--------------|---|--------------------------------------|----------------------|--|--|--|
| FU-0817 Cab | 0,25×0,45×0,65 | 0,5 | 8 | 0,8 | 0,15 | 0,5 |
| FU-0835 Cab | 0,25×0,45×1,15 | 1,3 | 18 | 1,8 | 0,2 | 0,5 |
| FU-1018 Cab | 0,35×0,55×0,7 | 0,8 | 12 | 1,2 | 0,15 | 0,8 |
| FU-1035 Cab | 0,35×0,55×1,15 | 2,0 | 25 | 2,5 | 0,3 | 0,8 |
| FU-1235 Cab | 0,35×0,55×1,15 | 2,0 | 25 | 2,5 | 0,3 | 0,8 |
| FU-1035 | 0,9×0,5×1,1 | 2,0 | 25 | 2,5 | 0,3 | 0,8 |
| FU-1054 | 1,0×0,6×1,6 | 2,0 | 37 | 3,7 | 0,4 | 0,8 |
| FU-1252 | 1,0×0,6×1,6 | 2,9 | 50 | 5,0 | 0,5 | 1,0 |
| FU-1354 | 1,0×0,6×1,6 | 3,5 | 62 | 6,2 | 0,6 | 1,2 |
| FU-1465 | 1,1×0,6×1,9 | 4,0 | 75 | 7,5 | 0,8 | 1,5 |
| FU-1665 | 1,1×0,6×1,9 | 5,2 | 100 | 10,0 | 1,0 | 2,0 |
| FU-1035 Twin | 1,4×0,5×1,1 | 2,0 | 50 | 2,5 | 0,3 | 0,8 |
| FU-1054 Twin | 1,5×0,6×1,6 | 2,0 | 74 | 3,7 | 0,4 | 0,8 |
| FU-1252 Twin | 1,5×0,6×1,6 | 2,9 | 100 | 5,0 | 0,5 | 1,0 |
| FU-1354 Twin | 1,6×0,6×1,6 | 3,5 | 124 | 6,2 | 0,6 | 1,2 |
| FU-1465 Twin | 1,7×0,6×1,9 | 4,0 | 150 | 7,5 | 0,8 | 1,5 |
| FU-1665 Twin | 1,8×0,6×1,9 | 5,2 | 200 | 10,0 | 1,0 | 2,0 |

¹ may vary depending on arrangement of pieces² supply water flow rate required for proper regeneration of system

9.3. Ecosoft FPA activated carbon systems

Requirements and limitations

| Installation room | |
|-----------------------|---|
| Ambient temperature | +5°C...+40°C |
| Relative humidity | ≤80% |
| Operating environment | indoor; free of corrosive vapors, airborne dust, and fibrous matter; sheltered from weather and direct sunlight |
| Power supply | |
| Electrical rating | 230 V, 50 Hz (EU adapter) |
| Power | 6 VA |
| Water supply | |
| Pressure | 2-6 bar (30-90 psi) |
| Water temperature | +4°C...+30°C |
| Prefilter rating | 100 µm |

Model range

| Model | Overall dimensions, m (width x depth x height) | Nominal flow rate, m ³ /h | Quantity of media, kg | Consumption of water per regeneration, m ³ | Required flow capacity, m ³ /h ¹ |
|----------|---|--------------------------------------|-----------------------|--|---|
| FPA-1054 | 0,3×0,3×1,6 | 0,6 | 25 | 0,3-0,4 | 1,0 |
| FPA-1252 | 0,4×0,4×1,6 | 0,9 | 25 | 0,4-0,6 | 1,5 |
| FPA-1354 | 0,4×0,4×1,6 | 1,0 | 50 | 0,5-0,7 | 1,7 |
| FPA-1465 | 0,4×0,4×1,9 | 1,2 | 50 | 0,5-0,8 | 2,0 |
| FPA-1665 | 0,5×0,5×1,9 | 1,6 | 75 | 0,7-1,0 | 2,5 |

¹ supply water flow rate required for proper regeneration of system

9.4. Ecosoft FPC catalytic carbon systems

Requirements and limitations

| Installation room | |
|-----------------------|---|
| Ambient temperature | +5°C...+40°C |
| Relative humidity | ≤80% |
| Operating environment | indoor; free of corrosive vapors, airborne dust, and fibrous matter; sheltered from weather and direct sunlight |
| Power supply | |
| Electrical rating | 230 V, 50 Hz (EU adapter) |
| Power | 6 VA |
| Water supply | |
| Pressure | 2-6 bar (30-90 psi) |
| Water temperature | +4°C...+30°C |
| Prefilter rating | 100 µm |

Model range

| Model | Overall dimensions, m (width × depth × height) | Nominal flow rate, m ³ /h | Quantity of media, kg | Consumption of water per regeneration, m ³ | Required flow capacity, m ³ /h ¹ |
|----------|---|--------------------------------------|-----------------------|--|---|
| FPC-1054 | 0,3×0,3×1,6 | 0,6 | 15 | 0,3-0,5 | 1,2 |
| FPC-1252 | 0,4×0,4×1,6 | 0,9 | 30 | 0,5-0,7 | 1,7 |
| FPC-1354 | 0,4×0,4×1,6 | 1,0 | 30 | 0,5-0,8 | 2,0 |
| FPC-1465 | 0,4×0,4×1,9 | 1,2 | 45 | 0,6-0,9 | 2,3 |
| FPC-1665 | 0,5×0,5×1,9 | 1,6 | 60 | 0,8-1,2 | 3,0 |

¹ supply water flow rate required for proper regeneration of system

9.5. Ecosoft FP media filtration systems

Requirements and limitations

| Installation room | |
|-----------------------|---|
| Ambient temperature | +5°C...+40°C |
| Relative humidity | ≤80% |
| Operating environment | indoor; free of corrosive vapors, airborne dust, and fibrous matter; sheltered from weather and direct sunlight |
| Power supply | |
| Electrical rating | 230 V, 50 Hz (EU adapter) |
| Power | 6 VA |
| Water supply | |
| Pressure | 2-6 bar (30-90 psi) |
| Water temperature | +4°C...+30°C |
| Prefilter rating | 100 µm |

Model range

| Model | Overall dimensions, m (width x depth x height) | Nominal flow rate, m ³ /h | Quantity of media, L | Consumption of water per regeneration, m ³ | Required flow capacity, m ³ /h ¹ |
|---------|---|--------------------------------------|----------------------|--|---|
| FP-1054 | 0,3×0,3×1,6 | 0,6 | 28,3 | 0,3-0,5 | 1,2 |
| FP-1252 | 0,4×0,4×1,6 | 0,9 | 56,6 | 0,5-0,7 | 1,7 |
| FP-1354 | 0,4×0,4×1,6 | 1,0 | 56,6 | 0,5-0,8 | 2,0 |
| FP-1465 | 0,4×0,4×1,9 | 1,2 | 84,9 | 0,6-0,9 | 2,3 |
| FP-1665 | 0,5×0,5×1,9 | 1,6 | 113,2 | 0,8-1,2 | 3,0 |

¹ supply water flow rate required for proper regeneration of system

10. WARRANTY

The manufacturer guarantees that the water treatment system does not contain workmanship defects and no such defects will arise within warranty period from the date of purchase from store provided that the technical requirements and operating conditions specified in this manual are strictly adhered to.

Malfunctions and defects caused by misuse or negligence or those not claimed within warranty period are not subject to warranty service. The warranty does not cover failure caused by mechanical impact, fire, natural disaster, freezing water, hot water and other types of mishandling or exposure to the environment. The manufacturer shall not be held liable for any damage to property or other damage, including lost profits, arising by chance or due to use or inability to use this water treatment system. Manufacturer's liability in accordance with this warranty is limited to the cost of the product.

This warranty does not cover:

- Filter media, salt, and other consumables
- Electrical equipment if the electrical mains has no protective earth or if no voltage regulator is used to protect against voltage spikes, brownouts etc
- Natural wear of equipment parts
- Damage caused by failure to replace or replenish consumables in terms provided in this document, as well as use of parts and consumables supplied by third party vendors

All claims regarding quality of water that has been purified using this water treatment system shall not be accepted unless supported by an analysis carried out by an accredited analytical laboratory.

Cases not specified under this warranty shall be resolved in accordance with the legislation.

11. INSTALLATION SHEET

Influent water quality data:

- pH _____
- hardness _____ mg/L CaCO₃
- iron _____ mg/l
- manganese _____ mg/l
- alkalinity _____ mg/L CaCO₃
- total dissolved solids _____ mg/l
- (other) _____
- _____
- _____
- _____

Supply pressure _____ MPa

Volume capacity _____ m³

Brine tank volume _____ L

System settings:

- 1. Regeneration Time _____ min
- 2. Preset stage duration: _____ min
 - backwash _____ min
 - brine and slow rinse _____ min
 - backwash _____ min
 - fast rinse _____ min
 - brine tank refill _____ min

Date _____ Stamp

For aftersale service and warranty claims, contact your dealer: _____

