

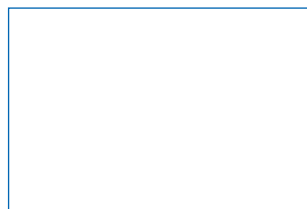

# BWT Perla Simplex Models

1-510998 / 13339 / 2021-02 / © BWT Wassertechnik GmbH / Printed in Germany

Subject to change!



For You and Planet Blue.



Thank you very much for the confidence that you have shown in us by purchasing a BWT appliance.



## Table of Contents

<b>1</b>	<b>Safety instructions . . . . .</b>	<b>5</b>	<b>7</b>	<b>General operation and display . 19</b>
1.1	General safety instructions . . . . .	5	7.1	Opening the Easy Fill technology cover. . . . . 19
1.2	Validity of this documentation . . . . .	5	7.2	Device status display . . . . . 19
1.3	Personnel qualifications . . . . .	5	7.3	Closing the Easy Fill technology cover . . . . . 19
1.4	Transport and installation . . . . .	6	7.4	Touch display controls . . . . . 20
1.5	Symbols used . . . . .	6	<b>8</b>	<b>Start-up . . . . . 21</b>
1.6	How safety instructions are displayed . . . . .	7	8.1	Starting up . . . . . 21
1.7	Product-specific safety instructions . . . . .	7	8.2	Installation check . . . . . 21
1.8	Important notes on the product . . . . .	8	8.3	Benefits of registering . . . . . 23
1.9	Definitions . . . . .	8	8.4	Connection wizard . . . . . 24
<b>2</b>	<b>Scope of delivery . . . . .</b>	<b>10</b>	8.5	User registration . . . . . 24
2.1	Optional extras. . . . .	11	8.6	Checking and setting the water hardness. . . . . 25
<b>3</b>	<b>Intended use. . . . .</b>	<b>12</b>	8.7	Completing the start-up procedure . . . . . 26
3.1	Proper use. . . . .	12	<b>9</b>	<b>Connection . . . . . 26</b>
3.2	Foreseeable misuse . . . . .	12	9.1	GSM – connection wizard . . . . . 27
3.3	Disclaimer . . . . .	12	9.2	LAN – connection wizard . . . . . 29
3.4	Other applicable documentation. . . . .	12	9.3	Wi-Fi – connection wizard . . . . . 31
<b>4</b>	<b>Function . . . . .</b>	<b>12</b>	9.4	Connection. . . . . 33
4.1	Operation . . . . .	12	9.4.1	Using the connection wizard . . . . . 33
4.2	Regeneration . . . . .	12	9.4.2	Performing a connection test . . . . . 34
4.3	Regenerative monitoring . . . . .	13	9.4.3	Managing connections . . . . . 34
4.4	Multi-info touch display . . . . .	13	9.5	Checking the connection status . . . . . 35
4.5	Interaction . . . . .	13	<b>10</b>	<b>Registration . . . . . 35</b>
4.6	Connectivity . . . . .	13	10.1	Starting registration on the product . . . . . 36
4.7	Safety . . . . .	14	10.2	Completing registration online . . . . . 38
4.7.1	AQA Safe valve. . . . .	14	<b>11</b>	<b>Operation . . . . . 39</b>
4.7.2	AQA Watch alarm function . . . . .	14	11.1	Home screen . . . . . 39
4.7.3	AQA Stop – moisture on floor . . . . .	14	11.2	Messages . . . . . 40
<b>5</b>	<b>Installation conditions . . . . .</b>	<b>15</b>	11.3	Menu overview. . . . . 41
5.1	General . . . . .	15	11.4	Settings . . . . . 41
5.2	Installation locations and environment. . . . .	15	11.4.1	General Information . . . . . 42
5.2.1	Installation conditions with pump. . . . .	15	11.4.2	External Module . . . . . 42
5.2.2	Reception conditions at the installation location. . . . .	15	11.4.3	Device configuration . . . . . 43
5.3	Inflow water . . . . .	15	11.4.4	Registration. . . . . 45
5.4	Functional and warranty conditions . . . . .	16	11.5	Functions . . . . . 46
<b>6</b>	<b>Installation . . . . .</b>	<b>16</b>	11.5.1	Regeneration/rinsing . . . . . 46
6.1	Installation diagram . . . . .	17	11.5.2	Shut down/return to operation . . . . . 47
6.2	Connecting the product . . . . .	17	11.5.3	Refilling operating materials . . . . . 48
6.2.1	Establishing a sewage system connection . . . . .	18	11.5.4	Holiday mode . . . . . 49
6.3	Electrical connections . . . . .	18	11.5.5	Maintenance . . . . . 49
			11.6	Info. . . . . 52
			11.6.1	Operating record . . . . . 53
			11.6.2	Serial no. / PNO . . . . . 53
			11.6.3	Consumption . . . . . 54
			11.6.4	Connection status . . . . . 55
			11.6.5	Device status . . . . . 55

11.7	Help . . . . .	56
11.7.1	Contact person . . . . .	56
11.7.2	FAQs . . . . .	56
<b>12</b>	<b>Additional functions . . . . .</b>	<b>57</b>
12.1	BWT Best Water Home app . . . . .	57
12.2	Remote operation of the product via a direct Wi-Fi connection (access point) . . . . .	58
12.3	Remote operation of the product via the home network (LAN / Wi-Fi) . . . . .	60
<b>13</b>	<b>Operator responsibilities . . . . .</b>	<b>61</b>
13.1	Intended operation . . . . .	61
13.2	Checks . . . . .	61
13.3	Inspection . . . . .	62
13.3.1	Inspection activities . . . . .	63
13.4	Maintenance in accordance with EN 806-5 . . . . .	64
13.5	Replacement of parts . . . . .	65
13.6	BWT expert maintenance . . . . .	65
13.7	Stoppages and re-activating the unit . . . . .	65
<b>14</b>	<b>Troubleshooting . . . . .</b>	<b>66</b>
14.1	Fault during start-up . . . . .	66
14.2	Fault during operation . . . . .	68
14.3	Faults affecting the additional functions . . . . .	69
<b>15</b>	<b>Warranty . . . . .</b>	<b>70</b>
15.1	Product returns . . . . .	70
15.2	Your contact at BWT . . . . .	70
<b>16</b>	<b>Decommissioning and disposal . . . . .</b>	<b>71</b>
16.1	Decommissioning . . . . .	71
16.2	Disposal . . . . .	71
16.2.1	Disposal of the transport packaging . . . . .	71
16.2.2	Disposal of old devices . . . . .	71
16.2.3	Disposal of old batteries . . . . .	71
<b>17</b>	<b>Technical data . . . . .</b>	<b>72</b>
17.1	Dimensions . . . . .	73
17.2	Diagram of peak flow . . . . .	74
<b>18</b>	<b>Standards and legal provisions . . . . .</b>	<b>75</b>
<b>19</b>	<b>Operating report . . . . .</b>	<b>76</b>
<b>20</b>	<b>German Drinking Water Ordinance notice . . . . .</b>	<b>77</b>

## **A Appendix . . . . . 78**

A.1	Connection set, DN 32/32 DVGW . . . . .	78
A.1.1	Intended use . . . . .	78
A.1.2	Installation conditions . . . . .	78
A.1.3	Installation . . . . .	79
A.2	Installation set for water softeners . . . . .	80

## **EU Declaration of Conformity . . . . . 81**

# 1 Safety instructions

## 1.1 General safety instructions

The product has been manufactured according to the generally recognised rules and standards of technology and complies with the legal regulations in force when it was brought into circulation.

Nevertheless, there is still a risk of damage to persons or property if you do not follow this chapter and the safety instructions in this documentation.

- Read this documentation carefully and in its entirety before working with the product.
- This documentation must be kept accessible to all users at all times.
- Always hand over the product to third parties together with the full documentation.
- Follow all of the instructions in relation to the proper handling of the product.
- If you detect damage to the product or the mains supply, stop its operation and notify a service technician immediately.
- Use only accessories, spare parts and consumable materials that have been approved by BWT.
- Adhere to the environmental and operating conditions specified in the "Technical data" section.
- Use your personal protective equipment. It ensures your safety and protects you from injury.
- Perform only tasks that are described in these operating instructions or that you have been trained to do by the manufacturer.
- Perform all tasks in compliance with all applicable standards and provisions.
- Instruct the operator in the function and operation of the product.
- Instruct the operator in the maintenance of the product.
- Instruct the operator in relation to potential dangers that may arise while operating the product.

## 1.2 Validity of this documentation

**This documentation applies exclusively to the specified product. See the label on the title page.**

This documentation is intended for operators, installers without training from the manufacturer, installers with training from the manufacturer (e.g. drinking water specialists), and service technicians.

This documentation contains important information for fitting the product safely and properly, starting up, operating, using, maintaining, and disassembling the product, and for correcting simple faults independently.

Read this documentation in full before working with the product. Pay particular attention to the chapter "Safety Instructions".

## 1.3 Personnel qualifications

The installation work described in these instructions requires basic knowledge of mechanics, hydraulics and electrical systems as well as knowledge of the corresponding specialist terms.

To ensure that the device is installed safely, this work must be performed only by a qualified specialist or a trained person under the guidance of a qualified specialist.

A **qualified specialist** is someone who can assess the work assigned to him or her, identify potential risks, and take suitable safety measures thanks to his or her specialist training, knowledge, and experience as well as his or her knowledge of the applicable regulations. Specialists must comply with applicable, industry-specific regulations.

A **trained person** is someone who has been instructed by a qualified specialist in the tasks entrusted to them and the potential dangers of improper conduct and, if necessary, trained and instructed on the necessary protective equipment and protective measures.

## 1.4 Transport and installation

To avoid damage during transport to the installation location, do not remove the product from the packaging until you have reached the relevant location. Then dispose of the packaging in the correct manner. Check that the delivery is complete.







When there is a risk of frost, empty all water supply parts.

Lift or transport the product or its components only from the designated suspension eyes or attachment points.

Install or mount the product on a sufficiently strong and level horizontal surface and adequately secure it against falling or tipping.

## 1.5 Symbols used

The following symbols in this documentation indicate specific sources of danger or important information:

	General danger to persons, systems or the environment.
	Danger caused by the mains voltage. Risk of death by electric shock!
	Instructions must be observed for safe operation.
	Remove the mains plug.
	Information that should be noted.
	The product must not be disposed of in household waste.
	Recycle the product after decommissioning.

## 1.6 How safety instructions are displayed

In this document safety instructions precede any sequence of actions that could cause harm to persons or damage to property. All hazard prevention measures must be followed.

Safety instructions are displayed as follows:

**⚠ SIGNAL WORD!**



**Source of hazard**  
(e.g. electric shock)

*Type of hazard (e.g. risk of fatal injury)!*

▶ Ways to prevent the hazard

## 1.7 Product-specific safety instructions

**⚠ DANGER!**



**Mains voltage!**

*Risk of death by electric shock!*

▶ Unplug device before any service and repair work.

▶ If the mains cable of the unit becomes damaged, you must replace it with the original cable from the manufacturer.

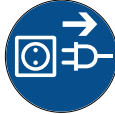

In the following sections, you will find product-specific safety instructions whenever you must perform certain safety-relevant actions on the device.

Signal word	Colour	Severity of the hazard
<b>DANGER</b>		<b>High-risk hazard.</b> Indicates a hazardous situation which, if not avoided, will result in death or serious injury.
<b>WARNING</b>		<b>Hazard with a moderate degree of risk.</b> Indicates a hazardous situation which, if not avoided, could result in death or serious injury.
<b>CAUTION</b>		<b>Low-risk hazard.</b> Indicates a hazardous situation which, if not avoided, may result in minor or moderate injury.
<b>NOTE</b>		<b>Important information and helpful tips.</b>

## 1.8 Important notes on the product



The product must be installed as described in the installation guide in compliance with the general requirements for the supply of water in Germany ["AVB Wasser"] V, section 12.2 by a water supply company or by a party registered in the water supply company's index of fitters.

- ▶ In accordance with TrinkwV (German Drinking Water Ordinance) section 16 and section 21, notify residents of the installation of the product, and explain how it works and which regenerative is used.

### Using treated drinking water with plants and aquatic animals

Each species of plant and aquatic animal requires water that contains a special combination of substances.

- ▶ Consult the standard literature and check whether treated drinking water can be used for watering plants or for filling ornamental lakes, aquariums or fish ponds.

### Handing over the product to the operator



If there is a delay between the installation/start-up of the unit and transfer to the operator, then the exchanger column must be manually regenerated.

- ▶ Inform the operator about the function, operation and maintenance of the product.
- ▶ Provide the operator with all instructions and additional information belonging to the product.

## 1.9 Definitions

**Inflow water:** Drinking water quality of the local water supplier. Depends on the region and is described using the degrees of hardness soft, medium or hard.

**Softened water:** Softened water, usually with water hardness of 0 – 9 °dH.

**Outlet water:** The water leaving the softening unit.

**Luxury water:** Water quality with water hardness of 4 – 6 °dH as recommended by the manufacturer.

**Blended water:** The product mixes (blends) fully softened soft water with inflow water to attain the desired outlet water.

**Fully softened water:** Water treated by the product with no added inflow water. Hardness value of 0.1 – 2.5 °dH.



## Microbiological and sensory quality of the (partially) softened water

The quality of the treated water depends greatly on the conditions under which the product is installed and operated. The most important factors are listed in the following table.

	Unfavourable conditions	BWT recommendations
Quality of the inflow water	Unsuitable and marginal quality inflow water may not be altered by the product.	Contact the BWT drinking water specialist or fitter.
Operating conditions	Long periods of stagnation, infrequent regeneration and incorrect configuration of the system can adversely affect the quality of the luxury water.	Observe the notes in the installation and operating manual. Contact the BWT drinking water specialist or fitter.
Quality of the regenerative	Impurities from inferior regeneratives with insoluble components cause deposits.	Use of BWT Perla tabs or regeneratives in accordance with DIN EN 973, type A.
Installation situation and conditions	Temperatures in the installation room greater than 25 °C, evaporation of solvents or an improper waste water connection may adversely affect the quality of the luxury water.	Observe the notes in the installation and operating manual.

When determining whether there is a problem with the sensory or microbiological quality of the treated water, it is important where in the system the quality is measured. For example, if the quality is measured at the tap, the water quality may be affected by the pipe material or by the presence of a water heater or hot water storage tank.

## 2 Scope of delivery

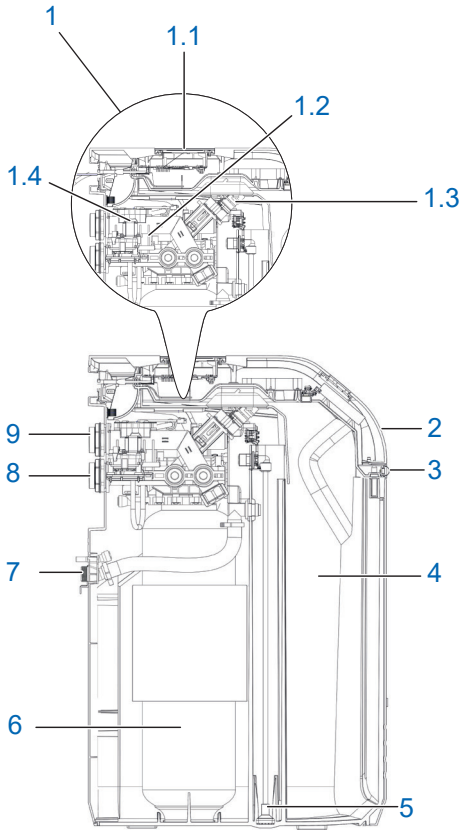

### NOTE





► The scope of delivery and illustrations may differ from the total scope specified here depending on the country. Optional components are marked with the \* symbol.

### BWT Perla Simplex water softener with:

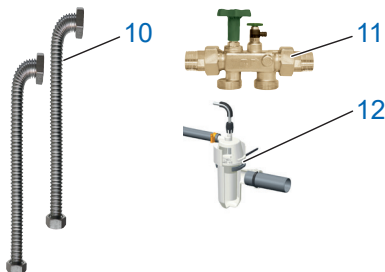
1	1.1 Microprocessor control with multi-info touch display
	1.2 Multiple-way control valve
	1.3 Blending valve with actuator
	1.4 Water meter for partially softened water
2	Easy Fill technology cover with LED status display
3	Proximity sensor
4	Integrated regenerative container
5	Brine suction system
6	Column containing ion exchanger material
7	Waste water connection
8	Water inlet with non-return valve
9	Water outlet
–	2 m rinsing water hose
–	2 m overflow hose, 18 x 24
–	Fasteners
*	Floor sensor for detecting a film of moisture (not shown)
*	BWT AQA test – hardness monitoring device
*	BWT luxury water test strips for monitoring the quality of the luxury water



10*	Connection set, DN 32/32 DVGW
11*	Connection fitting with integrated bypass
12*	BWT installation set

2.1 Optional extras (not on list of supplied parts)		Order no.
	BWT Bewasol brine lifting system	11808
	<ul style="list-style-type: none"> <li>• AQA Guard Wireless Water Sensor (required accessories for the AQA Guard function)</li> </ul>	11772
	LTE antenna, cable length of 3 m	1-444528
	Fault signal cable ZLT	1-433090

Mineral metering units (not on list of supplied parts)		Order no.
	BWT Bewados Plus E3 BWT Bewados Plus E20	17080 17081

## 3 Intended use

### 3.1 Proper use

This product is intended for the partial softening of drinking and service water. It is also designed to prevent malfunction and damage caused by calcification in water pipes and the connected fittings, devices, boilers and other equipment.

The performance specifications of the product must match the expected usage conditions. For more information, see DIN 1988-200 and the technical data in this installation and operating manual (see chapter "[17 Technical data](#)", [page 72](#)).

If the product is intended for a commercial application, a consultant from the manufacturer must conduct a test and issue an approval.

Operation of the product only with regular function checks and the performance of the maintenance measures required to ensure the safe operating condition of the product in accordance with the operating conditions for planning and construction.

### 3.2 Foreseeable misuse

- Failure to use the product over a longer period of time (7 days as per DIN EN 806-5).
- Failure to maintain the ambient conditions and operating conditions (see chapter "[17 Technical data](#)", [page 72](#)).
- Failure to comply with the maintenance and service intervals specified in this manual.
- The use of unauthorised consumables and spare parts.

### 3.3 Disclaimer

The manufacturer is released from any liability if the customer intentionally or forcibly removes guards or safety devices, if the customer wilfully modifies or circumvents the same, or if the customer does not follow the instructions in this operating manual or on the system.

### 3.4 Other applicable documentation

- Data protection notice
- Material safety data sheets

## 4 Function

The BWT Perla product range Simplex includes various simplex water softeners based on ion exchange. The products are filled with organic ion exchange material.

### 4.1 Operation

- Adaptive sequential operation allows for maximum soft water availability and minimises stagnation in the column.
- Regeneration is triggered volumetrically (depending on the quantity of water). This means that no remaining supply of softened water is discarded during regeneration.
- During the regeneration process, untreated inflow water is available.
- Ideally, the regeneration time occurs at night, as water consumption is usually lower during this period.
- If the capacity falls below 50% before the query time, proportional regeneration starts immediately.
- If the capacity does not fall below 50% until after the query time, the control system assumes that the remaining capacity is sufficient to last until the regeneration time.
- Regeneration begins immediately if the capacity is exhausted; otherwise it starts at the selected regeneration time.

### 4.2 Regeneration

- Exchange of hardness forming substances Ca and Mg ions for Na ions from the regenerative at the ion exchanger.
- A precision brine meter measures out the brine required.
- The product is equipped with a device that disinfects the ion exchange material during regeneration.
- By measuring data acquisition during brine extraction, the regeneration process is adapted to the respective pressure conditions, the regenerative and regeneration water consumption is reduced to the required minimum.
- The optimised brine preparation process produces as much brine as needed for regeneration in less than 0.5 hours.

- The brine collects in a special sink of the regenerative container and is fully extracted from there. After brine extraction, there is no liquid left in the regenerative container.
- An ultrasound sensor in the Easy Fill technology cover measures the regenerative level.
- The regeneration is proportional. 100% regeneration takes place after 72 hours at the latest for hygiene purposes.

### 4.3 Regenerative monitoring

- 100% in the multi-info touch display corresponds to a regenerative filling level of approx. 46 cm.
- From a level of around 20%, the device status indicator changes from “blue” to “yellow” to signal a need to refill the regenerative.

### 4.4 Multi-info touch display

The product is equipped with a touch display. It can be operated intuitively and provides a quick overview of all product parameters.

During start-up, you can select basic parameters on the display:

- Country-specific settings at the location of operation
- Unit for measuring water hardness at the location of operation (°dH, °f, mol/m<sup>3</sup>, ppm calcium carbonate)
- Inflow water hardness (enter manually or input the value stored in the **hydromaps** water hardness database for the location of operation)
- Desired outlet water hardness

Depending on your settings, you will see the current parameters on the display during operation:

- Current flow volume in l/h (fully softened water plus inflow water)

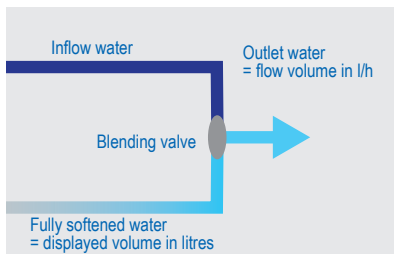

### NOTE



► A comparison of the displayed volumes using a domestic water meter is not possible.

- Water and regenerative consumption
- Regenerative level (via ultrasound sensor in the Easy Fill technology cover)
- Reminders for filter backwashing, filter change and other maintenance work

### 4.5 Interaction

A BWT mineral metering unit can be plugged into the unit at any time.

Up to 10 AQA Guard Wireless Water Sensors (order no. 11772) can be taught.

### 4.6 Connectivity

#### BWT DES (BWT Digital Eco System)

Various functions may be available depending on the product and market:

- GSM connection to the server for full functionality and database updates.
- Wi-Fi or LAN connection to your local network to control and monitor the product via PC, smartphone or tablet.
- EnOcean® interface for the AQA Guard function.

Connectivity extends the functionality of the product and allows the system to be registered in order to use advanced operating and maintenance functions via the **BEST WATER HOME** app.

### NOTE



► Depending on the product, not all types of connectivity are available.

## 4.7 Safety

### 4.7.1 AQA Safe valve

- The AQA Safe valve closes the waste water valve in the event of a power failure and thus protects against water damage caused by rinsing water, especially when the rinsing water is being drained by a pump that stops functioning when the power fails.

### 4.7.2 AQA Watch alarm function

- The programmable AQA Watch alarm function monitors the water supply to the building and issues a warning message if low flow rates (< 60 l/h) over a longer period of time (> 10 minutes) indicate a problem in the pipe network (e.g. leakage, dripping drain tap or leaky toilet cistern).

### 4.7.3 AQA Stop – moisture on floor

- If the product's floor sensor detects water on the floor, the water supply in the direction of flow from the unit is shut off and a warning issued. The floor sensor only responds to drinking water (minimum conductivity of 500  $\mu\text{S/cm}$ ).

### AQA Stop – water quantity limitation

- To minimise water damage, the control valve shuts off the water supply downstream of the product following continuous flow of a preset water volume.
- If larger quantities of water are to be drawn without interruption (e.g. to fill a large whirlpool, swimming pool, etc.), this function may need to be deactivated or acknowledged after activation. The maximum continuous flow must be observed.

### AQA Guard Wireless Sensor (optional)

- Installation of up to 10 AQA Guard Wireless Water Sensors (order no. 11772) in the building to receive an alarm message in case of leakage.

## 5 Installation conditions

### 5.1 General

The product must be installed as described in the installation guide in compliance with the general requirements for the supply of water in Germany ["AVB Wasser"] V, section 12.2 by a water supply company or by a party registered in the water supply company's index of fitters.

Observe all applicable local installation regulations, general guidelines, sanitary requirements and technical specifications.

### 5.2 Installation locations and environment

Softening units may not be installed in systems that provide water for fire extinguishing purposes.

The installation location must meet the following criteria:

- Protected against frost, chemicals, dyes, solvents and fumes.
- Structurally waterproofed.
- Easy to connect to the water supply system.
- Sufficient clearance to open the technology cover. (For minimum clearance, see chapter "17.1 Dimensions", page 73; the clearance should be greater to allow for convenient refilling of regenerative).

#### NOTE



► A sewage system connection, floor drain and separate power supply must be available in the immediate vicinity. For power supply data, see chapter "17 Technical data", page 72.

If there is no floor drain and the softening unit does not have an integrated AQA Stop function, a separate safety device will have to be installed on site in the direction of flow upstream of the softening unit.

This safety device (e.g. external AQA Stop) has to shut off the water supply when there is no current in order to prevent unintended water leakage from the softening unit if the product is damaged.

The rated mains power and the requisite operating pressure must be present at all times. For data, see chapter "17 Technical data", page 72. A separate means of protection against a shortage of water is not provided and must be installed on site if desired.

### 5.2.1 Installation conditions with pump

If the flushing water is fed into a pump, the pump must be appropriately equipped and sized:

- The pump must be resistant to salt water.
- Flow rate at least 2 m<sup>3</sup>/h or 35 l/min for products for building services.
- Flow rate at least 3 m<sup>3</sup>/h or 50 l/min for products in the Rondomat and BWT Perla Professional series.
- Appropriate larger sizing if the pump is used simultaneously for other products.

### 5.2.2 Reception conditions at the installation location

In order to benefit from the connectivity of the product, either GSM reception or integration into a home network via LAN or Wi-Fi should be possible at the installation location (see chapter "9 Connection", page 26).

### 5.3 Inflow water

The inflow water must always meet the specifications of the Trinkwasserverordnung (German Drinking Water Ordinance) or EU directive 98/83/EC. The total dissolved iron and manganese must not exceed 0.1 mg/l. The inflow water must always be free of air bubbles. Install a bleed device if necessary.

If the treated water is intended for human consumption as defined in the Trinkwasserverordnung (German Drinking Water Ordinance), the ambient temperature must not exceed 25 °C.

If the treated water is intended for industrial purposes only, the ambient temperature must not exceed 40 °C.

The product's maximum operating pressure must never be exceeded (see chapter "17 Technical data", page 72). If the network pressure is higher, a pressure reducer must be installed upstream of the product.

The product requires a minimum operating pressure to function correctly (see chapter "17 Technical data", page 72).

The optimal operating pressure is between 3 and 6 bar.

## 5.4 Functional and warranty conditions

Softening units require regular functional monitoring, maintenance and replacement of important parts after certain intervals.

The amounts of metering substance and regenerative necessary are subject to the level of consumption, which depends on operating conditions.

Softening units must be cleaned regularly and also disinfected if necessary. See this installation and operating manual for the maintenance intervals. We recommend that you enter into a service agreement.

During pressure fluctuations and surges, the sum of the pressure surge and the standing pressure must not exceed the nominal pressure. The positive pressure surge must not exceed 2 bar and the negative pressure surge must not be less than 50% of the self-adjusting flow pressure (see DIN 1988200/3.4.3).

Continuous operation of the softening unit with water containing chlorine or chlorine dioxide is possible if the concentration of free chlorine/chlorine dioxide does not exceed 0.5 mg/l.

Continuous operation with water containing chlorine or chlorine dioxide can lead to premature ageing if an organic ion exchange material is used. A softening unit can reduce the concentration of free chlorine and chlorine dioxide. In other words, the concentration in the outflow of a softening unit is generally considerably lower than in the inflow.

In order to benefit from the product's connectivity-based features, one of the following must be present at the installation location:

- GSM signal strength between -40 to -89 dBm
- Wi-Fi signal strength between -20 to -89 dBm
- Network connection with RJ45 socket within 1.5 m

## 6 Installation

The following conditions must be met before the product can be installed:

- The pipeline network must be rinsed.
- You must check whether a mineral metering device needs to be installed downstream from the product for the purpose of preventing corrosion.
- Corrosion-resistant pipe materials are used for installation. Pay attention to corrosion-causing chemical properties when different pipe materials are combined (mixed installation), even in the inflow direction upstream of the product.
- A protective filter must be installed in the direction of flow 1 m upstream of the product. The filter must be functional before the product is installed. This is the only way to ensure that dirt and corrosive particles do not enter the product.
- Suitable taps for sampling must be installed upstream and downstream of the product in accordance with the specifications of VDI 6023.
- The hose attached to the overflow point of the regenerative container and the rinsing water hose must be routed at an incline to the sewage system or connected to a pump.
- According to EN 1717, the rinsing water hose and the overflow hose must be connected to the sewage system at a specified distance above the highest possible waste water level. (Distance is greater than the diameter of the drain pipe.)



## 6.1 Installation diagram

(Illustration serves as an example. The individual installation must be adapted to local conditions.)

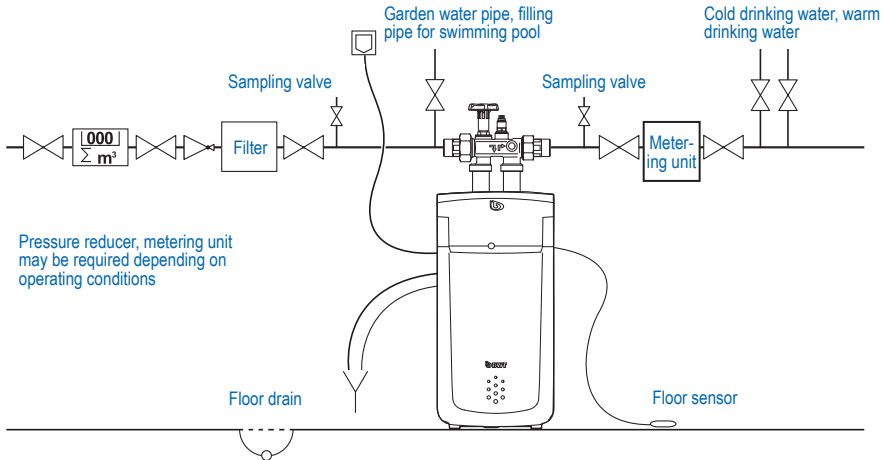

### Connection fitting

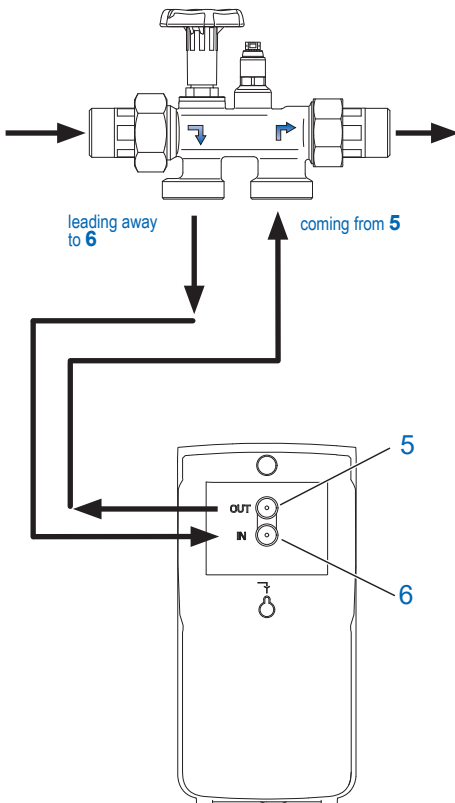

## 6.2 Connecting the product

Connect the product to a suitable connection fitting with integrated bypass.

### NOTE



► The following descriptions are based on the installation and use of the BWT connection fitting.

- Read the separate installation instructions for the connection fitting. Failure to do so will void the warranty in the event of damage.
- Connect the connection fitting according to the adjacent diagram while observing the arrows indicating the direction of flow.
- Connect a corrugated hose to the outlet of the connection fitting.
- Connect the corrugated hose to the product's inflow water connection **IN (6)** with a seal.
- Connect the other corrugated hose with a seal to the product's outlet water connection **OUT (5)**.
- Connect this corrugated hose to the inlet of the connection fitting.
- Open the handwheel (bypass) on the connection fitting.

### 6.2.1 Establishing a sewage system connection

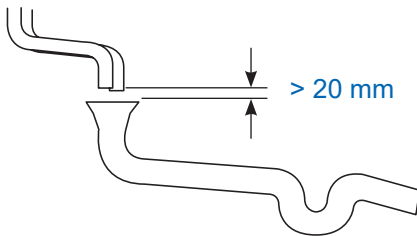
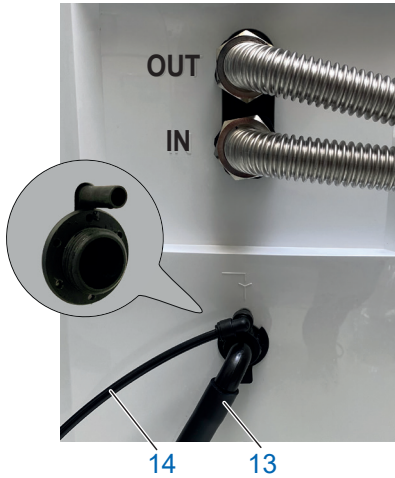

- ▶ Connect the overflow hose  $\varnothing$  24 mm (13) to the product.
- ▶ Route the overflow hose with an incline of at least 10 cm to the sewage system connection (drain), or connect it to the included siphon in accordance with the installation instructions and fasten it sufficiently.
- ▶ Connect the rinsing water hose  $\varnothing$  8 mm (14) to the product.
- ▶ Route the rinsing water hose to the sewage system connection (drain) or connect it to the included siphon.
- ▶ Check the plug connection by pulling the connector back slightly.

#### NOTE



- ▶ In accordance with EN 1717, the rinsing water and overflow hoses must be connected to the sewage system at least 20 mm above the highest possible waste water level (unimpeded drainage).
- ▶ The flushing water and overflow hoses must not be connected or constricted at any point.

- ▶ Place the floor sensor on the floor.

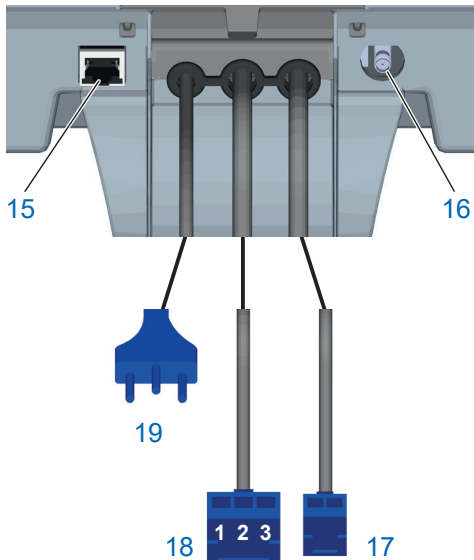

### 6.3 Electrical connections

The following connections are available at the rear of the Easy Fill technology cover:

15	LAN (RJ45) connection
16	GSM antenna connection (optional, at low signal strength)
17	Dosing pump connection (2-wire)
18	Fault signal contact connection (3 wire), potential-free changeover contact (max. 24 V / 0.5 A) Terminal assignment: Terminal 1-2 closed during operation Terminal 3-2 closed during fault
19	Network cable (country-specific)

Connect the product to the power supply only during start-up.

Figure may differ.

## 7 General operation and display

The touch display switches off in sleep mode (energy-saving mode).

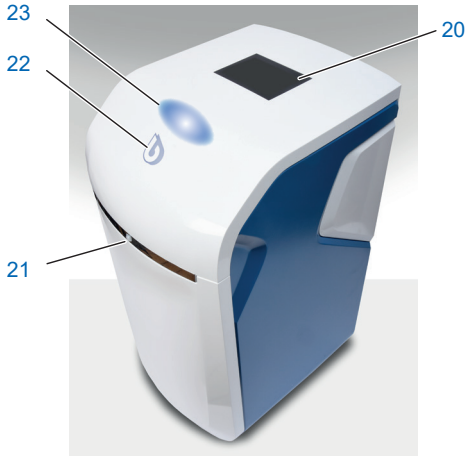

20	Touch display
21	Proximity sensor
22	Device status display
23	Area for the tip-on mechanism to open the Easy Fill technology cover





### 7.1 Opening the Easy Fill technology cover

The Easy Fill technology cover is equipped with a handleless tip-on mechanism.

► Tap lightly on the surface of the housing. The Easy Fill technology cover opens.

### 7.2 Device status display

The colour of the BWT logo on the technology cover indicates the device status:



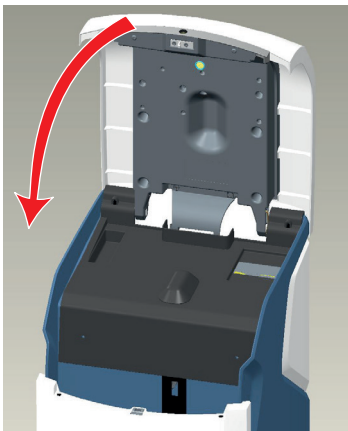





	Lit blue	Normal operation
	Flashing blue	Level measurement in progress (regenerative level > 20%)
	Lit yellow	Notification (e.g. regenerative ≤ 20%)
	Flashing yellow	Level measurement in progress (regenerative level ≤ 20%)
	Lit red	Fault (e.g. AQA Stop Sensor triggered)



### 7.3 Closing the Easy Fill technology cover

► Press the Easy Fill technology cover down gently until it snaps shut.

## 7.4 Touch display controls

	Menu
	Next / Next page
	Back / Previous page
	Start page / Status overview
	Regeneration in progress
	GSM signal strength
	LAN
	Wi-Fi signal strength
	Server connection active

The touch display provides important information and can be operated intuitively.

It switches on automatically by tapping the display once.

If it is not used, it switches off after an adjustable time (energy-saving mode).

## 8 Start-up

### 8.1 Starting up

- ▶ Insert the mains plug.

The start-up assistant is activated.

#### NOTE



▶ The display illustrations for your product depend on the respective scope of delivery and may differ from the illustrations in this manual.

Display settings

Country

Language

Hardness unit

#### Display settings

- ▶ Select your country in the top field.
- ▶ Select your language in the middle field.
- ▶ Select the unit used to indicate the water hardness in the lower field.
- ▶ Press **CONTINUE**.

Welcome to your start-up assistant

#### Start screen

- ▶ Press **CONTINUE**.

<
Installation check

The following installations must be completed to start up:

1

Waste water connection

2

Connection fitting

3

AQA Stop – sensor

4

Regenerative refilling

### 8.2 Installation check

The installation check verifies that your product is properly connected.

- ▶ Press **START CHECK** to begin.

## Waste water connection according to EN1717 1/4 X



- Flushing water hose
- Overflow hose

CANCEL

INSTALLED

**Installation check 1/4: Waste water connection according to EN1717**

- ▶ Check that the waste water hoses are connected properly (see chapter [“6.2.1 Establishing a sewage system connection”](#), page 18).

If all criteria for correct installation are satisfied:

- ▶ Press **INSTALLED**.

## Ports on the connection fitting 2/4 X

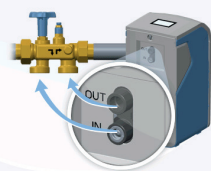

- Connect the system and connection fitting as shown
- Open the connection fitting
- Rinsing starts

CANCEL

INSTALLED

**Installation check 2/4: Ports on the connection fitting**

- ▶ Ensure that the hoses for the inflow and outlet water at the connection fitting are correctly connected (see chapter [“6.2 Connecting the product”](#), page 17).

- ▶ Open the connection fitting by turning the handwheel anti-clockwise until it stops. Rinsing of the product starts.

If all criteria for correct installation are satisfied:

- ▶ Press **INSTALLED**.

## AQA Stop Sensor 3/4 X



- Properly laid out

CANCEL

CONFIRM

**Installation check 3/4: AQA Stop Sensor**

- ▶ Check the connection and position of the floor sensor (see chapter [“6.1 Installation diagram”](#), page 17).

If all criteria for correct installation are satisfied:

- ▶ Press **CONFIRM**.

## Regenerative refilling 4/4 X



- Regenerative container is filled

**Caution:**  
Do not pour water into the device

CANCEL

CONFIRM

**Installation check 4/4: Refilling the regenerative**

- ▶ Press lightly on the Easy Fill technology cover to open it (see chapter [“7.1 Opening the Easy Fill technology cover”](#), page 19).

- ▶ Add up to 30 kg of regenerative (regenerative tablets in accordance with DIN EN 973 type A) to the regenerative container. The maximum level of 100% on the display corresponds to a filling level of approx. 46 cm.

**Caution:** Do not fill with water!

- ▶ Press the Easy Fill technology cover down gently until it snaps shut.

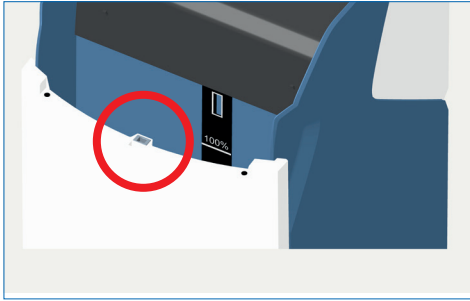

## NOTE



- ▶ When filling the regenerative, make sure that no dirt gets into the locking mechanism (red circle).
- ▶ Overfilling past the 100% mark can result in implausible fill level values being reported. Remove regenerative in case of overfilling.
- ▶ The product must not be operated with Sanitabs or Sanisal.
- ▶ Additional information can be found in chapter "11.5.3 Refilling operating materials", page 48.

▶ Press CONFIRM.

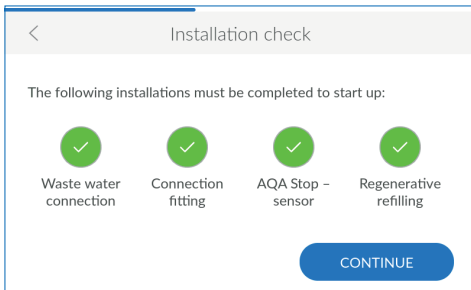

### Completing the installation check

The installation check is completed successfully when all four icons are green.

▶ Press CONTINUE.

The start-up flushing runs in the background. Device registration begins.

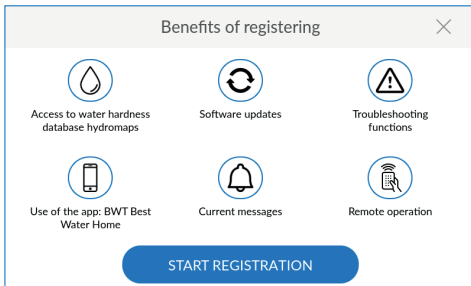

### 8.3 Benefits of registering

You can only use all BWT services if you register your product:

- Access to the water hardness database
- Regular software updates
- Troubleshooting
- Use of the BWT Best Water Home app
- Current messages
- Remote operation

▶ Press START REGISTRATION.

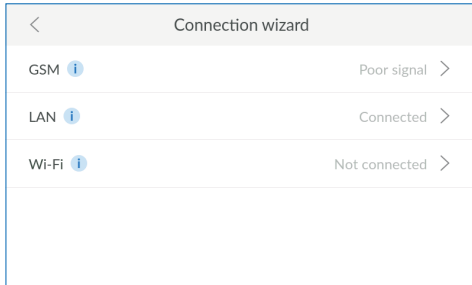

## 8.4 Connection wizard

If you perform registration during start-up, the connection wizard starts automatically and you can skip the following text section.

If you want to register later, you must start the connection wizard manually.

The connection wizard supports setting up the connection type that the product uses to connect to the Internet.

More detailed information on the respective connection type can be found in the following chapters:

- [“9.1 GSM – connection wizard”, page 27](#)
- [“9.2 LAN – connection wizard”, page 29](#)
- [“9.3 Wi-Fi – connection wizard”, page 31](#)

### NOTE



▶ If you do not want to connect the product to the Internet, exit the connection wizard by pressing **X** in the header.

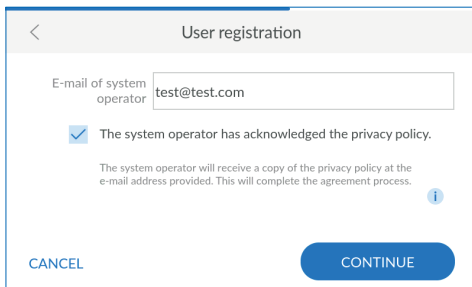

## 8.5 User registration

User registration starts if the connection was successfully established.

- ▶ Tap inside the text box. A keypad is displayed.
- ▶ Enter your e-mail address.
- ▶ Check the box to confirm that you have read and understood the privacy policy.
- ▶ Press **CONTINUE**.
- ▶ Enter your e-mail address again. Double entry eliminates input errors.
- ▶ Press **CONTINUE**.



### Entering the postcode

Entering the postcode will automatically determine the water hardness from the **hydromaps** water hardness database for the installation location of your product.

- ▶ Tap inside the text box. A keypad is displayed.
- ▶ Enter the postcode of the installation location of your product and press Enter to confirm your entry.

### Selecting the district

- ▶ Select your district if applicable.
- ▶ Press **CONTINUE**.

## 8.6 Checking and setting the water hardness

For registered products, the inflow water hardness is taken from the **hydromaps** water hardness database. Check that the database value matches the water hardness at the installation location and adjust the value for the inflow water hardness if necessary.

- ▶ If necessary, press **ENTER VALUE MANUALLY**.
- ▶ Enter the water hardness at the installation location.
- ▶ Select the desired outlet water hardness (luxury water with approx. 4 °dH), or enter it manually.

After entering, the display automatically skips forward.

### NOTE



- ▶ Do not set the outlet water hardness too low, as this can lead to increased foaming of soaps (e.g. in the washing machine).
- ▶ When setting the outlet water hardness, ensure that the maximum permissible sodium concentration of 200 mg/l in accordance with the German Drinking Water Ordinance is not exceeded.

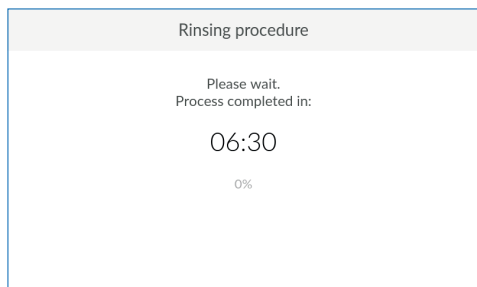

## 8.7 Completing the start-up procedure

### Rinsing procedure

A rinsing procedure occurs after start-up. If it has not been completed, then the remaining run time is displayed.

► Wait for the rinsing procedure to end.

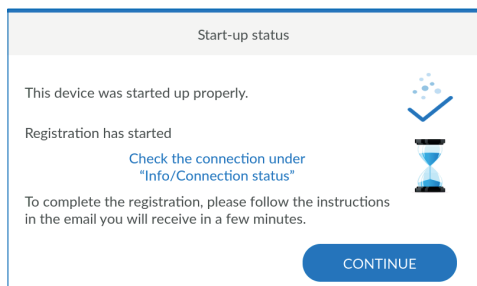

### Start-up status

The start-up process is complete following the rinsing procedure.

► Press **CONTINUE**.

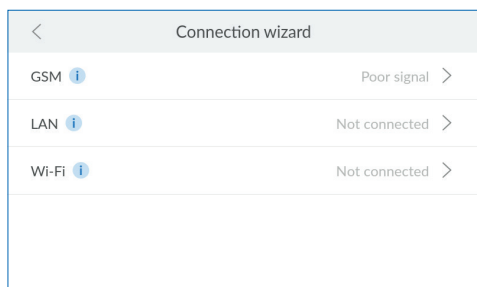

## 9 Connection

During or after start-up, the connection wizard will guide you through the possible types of connection and registration.

### Selecting the connection type

- Select the connection type used by the product to connect to the Internet.
- Refer to the related chapter for more information on the selected connection type:
  - [“9.1 GSM – connection wizard”, page 27](#)
  - [“9.2 LAN – connection wizard”, page 29](#)
  - [“9.3 Wi-Fi – connection wizard”, page 31](#)

If you do not want to connect the product to the Internet, press **X** in the header to exit the connection wizard.

## 9.1 GSM – connection wizard

### NOTE



► GSM connectivity is not available for all products.

The product can be connected to the Internet independently of the home network via GSM thanks to an integrated SIM card. This requires a sufficient GSM connection. There are no additional costs.

If necessary, start the connection wizard:

☰ > **Settings** > **General Information** > **Connection** > **Connection wizard**

► Press **GSM**.

► Check the connection quality:

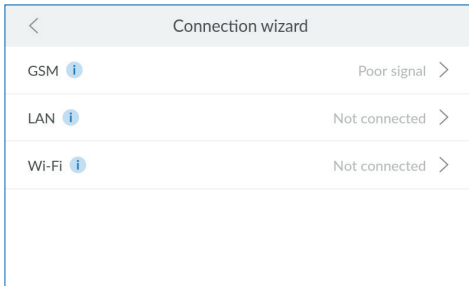

### Good GSM connection

► Press **CONTINUE** to continue with the registration.

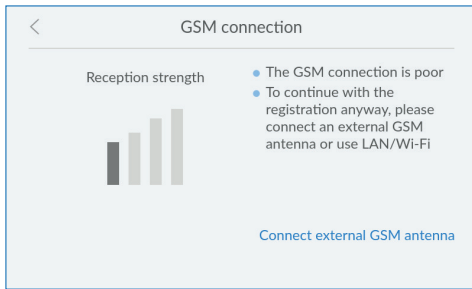

### Poor GSM connection

If the GSM connection is poor, you can improve it by using an external GSM antenna.

- ▶ Contact BWT Customer Service to acquire an external antenna.
- ▶ Press **CONNECT EXTERNAL GSM ANTENNA** and follow the instructions.

If you do not have a suitable external GSM antenna, you can also establish the connection later or via LAN or Wi-Fi:

- ▶ Press **<** to return to the connection wizard and select another type of connection.

### Connecting an external GSM antenna

- ▶ Open the Easy Fill technology cover of the product.
- ▶ Loosen the screws on the internal cover and then remove it.
- ▶ Route the cable of the external antenna through the opening on the back of the product.
- ▶ Connect the external antenna to the connector on the product (see chapter [“6.3 Electrical connections”](#), page 18).
- ▶ Attach the internal cover.
- ▶ Close the technology cover so that the cables are not pinched.
- ▶ Press **CONTINUE**.

If the connection quality is still poor, the installation location is outside the range of the GSM.

However, you can also connect the product via LAN or Wi-Fi to continue with registration.

Registration can also be postponed until a later time.

### NOTE



- ▶ The external antenna must be initialised via the connection wizard and thus automatically activated. If necessary, run the connection wizard again.
- ▶ Ensure that the technology cover can be easily closed and that the cables do not have any kinks.

## 9.2 LAN – connection wizard

If you have a network connection at the installation location of your product, use the RJ45 interface to establish the Internet connection via your network.

If necessary, start the connection wizard:

☰ > Settings > General Information > Connection > Connection wizard

▶ Press LAN.

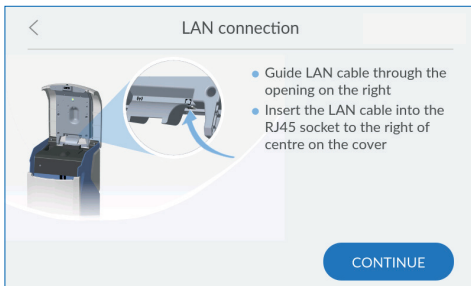
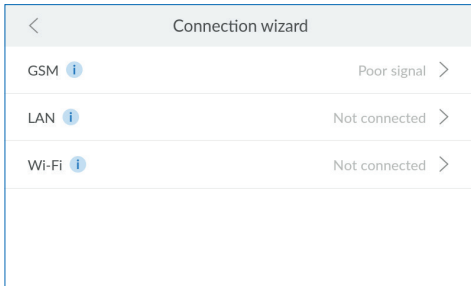

### Connecting the network cable

- ▶ Open the Easy Fill technology cover of the product.
- ▶ Connect an Ethernet cable to a network connection near the product.
- ▶ Loosen the screws on the internal cover and then remove it.
- ▶ Route the Ethernet cable through the opening on the back of the product.
- ▶ Connect the Ethernet cable to the connector on the product (see chapter “[6.3 Electrical connections](#)”, page 18).
- ▶ Attach the internal cover.
- ▶ Close the technology cover so that the cables are not pinched.
- ▶ Press CONTINUE.

### NOTE



- ▶ The LAN connection must be initialised via the connection wizard and thus automatically activated.
- ▶ Ensure that the technology cover can be easily closed and that the cables do not have any kinks.

< LAN connection

How do you want to connect the system to the home network?

Obtain IP address automatically  
Automatic assignment of IP address via DHCP

AUTOMATIC

Assign IP address manually  
Static assignment of IP address

MANUAL

### Obtaining the network connections automatically

The network settings can be obtained automatically via DHCP.

- ▶ Press **AUTOMATIC** to use your network settings.

If you do not want to obtain your network settings via DHCP, you can also assign them manually. To do so, you must know your network settings.

- ▶ Press **MANUAL** if you want to assign the network settings yourself.

< LAN connection

IP address

Subnet mask

Standard gateway

CONTINUE

### Entering network settings manually

You must know your network settings. If necessary, contact your system administrator.

- ▶ Complete the respective fields by entering the IP address, subnet mask and standard gateway according to your network settings.
- ▶ Press **CONTINUE**.

LAN connection

LAN connection has been established.  
IP address: 10.1.8.20

CONTINUE

### LAN connection was successful

The IP address of the product is displayed if the connection to the home network via LAN was successful.

- ▶ Press **CONTINUE** to continue with the registration (see chapter "[10 Registration](#)", page 35).

LAN connection

LAN connection could not be established.  
Scan QR code for more information.



REPEAT

CONTINUE

### LAN connection was unsuccessful

If the connection to the home network via LAN was not successful, you can scan the displayed QR code with an Internet-enabled mobile device to obtain further information.

- ▶ Press **REPEAT** to attempt to connect again.
- ▶ Press **CONTINUE** to exit the connection wizard.

However, you can also connect the product via Wi-Fi or GSM to continue with registration.

Registration can also be postponed until a later time.

### 9.3 Wi-Fi – connection wizard

To connect the product to the home network via Wi-Fi, you need the name of the Wi-Fi (SSID) and the corresponding password (WPA2 key).

If necessary, start the connection wizard:

☰ > **Settings** > **General Information** > **Connection** > **Connection wizard**

▶ Press **Wi-Fi**.

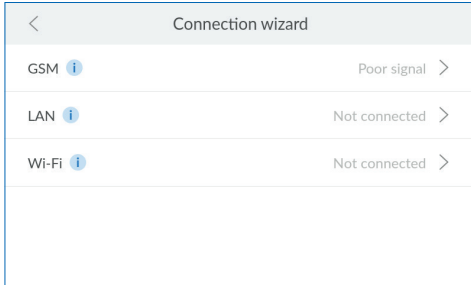

#### Starting the Wi-Fi search

▶ Press **CONTINUE** to search for available Wi-Fi networks.

If your Wi-Fi router supports WPS, you can use it to establish the connection automatically.

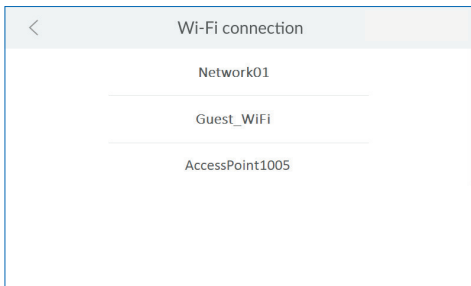

#### Selecting Wi-Fi

▶ Press the desired Wi-Fi network to select it.

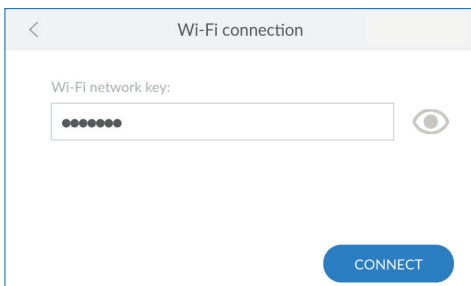

#### Entering the security key

▶ Press the open field and then enter the security key (e.g. WPA2 key) of the selected Wi-Fi network.

▶ To check the entry afterwards, press the eye symbol next to the input field, to reveal the key.

Wi-Fi connection

How do you want to connect the system to the home network?

Obtain IP address automatically  
Automatic assignment of IP address via DHCP

AUTOMATIC

Assign IP address manually  
Static assignment of IP address

MANUAL

### Obtaining the network connections automatically

The network settings can be obtained automatically via DHCP.

► Press **AUTOMATIC** to use your network settings.

If you do not want to obtain your network settings via DHCP, you can also assign them manually. To do so, you must know your network settings.

► Press **MANUAL** if you want to assign the network settings yourself.

Wi-Fi connection

IP address

Subnet mask

Standard gateway

CONTINUE

### Setting the network settings manually

You must know your network settings. If necessary, contact your system administrator.

► Complete the respective fields by entering the IP address, subnet mask and standard gateway according to your network settings.

► Press **CONTINUE**.

Wi-Fi connection

Wi-Fi connection has been established.  
IP address: 192.168.178.25

CONTINUE

### Wi-Fi connection was successful

The IP address of the product is displayed if the connection to the home network via Wi-Fi was successful.

► Press **CONTINUE** to continue with the registration (see chapter "[10 Registration](#)", page 35).





### Wi-Fi connection was not successful

If the connection to the home network via Wi-Fi was not successful, you can scan the QR code with an Internet-enabled mobile device to obtain further information.

- ▶ Press **REPEAT** to attempt to connect again.
- ▶ Press **CONTINUE** to exit the connection wizard.

However, you can also connect the product via GSM or LAN to continue with registration.

Registration can also be postponed until a later time.

## 9.4 Connection

All connections can be activated or deactivated at any time.

- ▶ Open the connection settings:

☰ > **Settings** > **General Information** > **Connection**

You can start the connection wizard, perform a connection test (ping), activate/deactivate connections or set up a new connection in the **Connection** menu.

### 9.4.1 Using the connection wizard

If necessary, start the connection wizard:

☰ > **Settings** > **General Information** > **Connection** > **Connection wizard**

- ▶ Read the related section:

- [“9.1 GSM – connection wizard”, page 27](#)
- [“9.2 LAN – connection wizard”, page 29](#)
- [“9.3 Wi-Fi – connection wizard”, page 31](#)

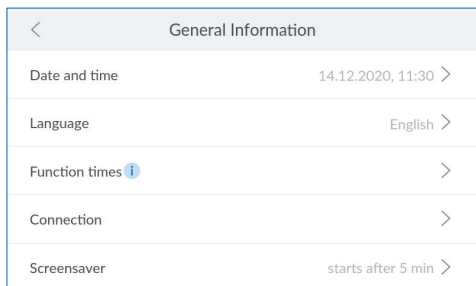

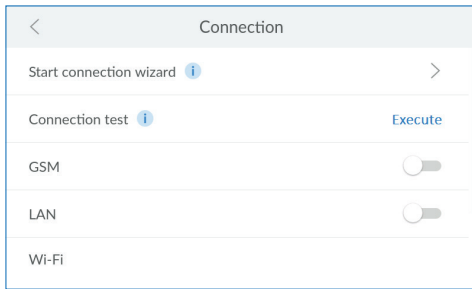

### 9.4.2 Performing a connection test

The connection test checks the connection of your product to and from the cloud. This ensures that the connection is working from both sides.

**Requirement:** Connection setup via GSM, LAN or Wi-Fi, as well as registration, must have been successfully performed.

#### Starting the connection test:

☰ > Settings > General Information > Connection

▶ Press **Connection test**.

The connection is active if the response time is displayed.

If **Failed** is displayed, check the connection or contact your system administrator if necessary.

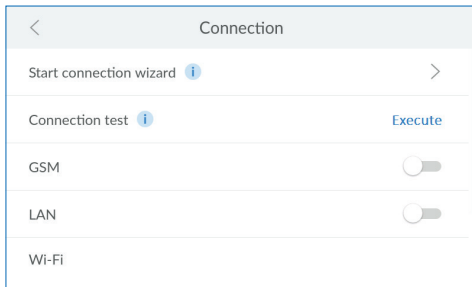

### 9.4.3 Managing connections

#### Activating connections

The connection wizard guides you through the menu to set up the desired connection.

The sliding switches can be used to activate/deactivate connections. The sliding switches of activated connections are displayed in Blue.

▶ Press the sliding switch of the connection you want to activate or start the connection wizard. Further information is available in the related chapter:

- [“9.1 GSM – connection wizard”, page 27](#)
- [“9.2 LAN – connection wizard”, page 29](#)
- [“9.3 Wi-Fi – connection wizard”, page 31](#)

#### Deactivating connections

Existing connections can be deactivated at any time.

☰ > Settings > General Information > Connection

▶ Press the sliding switch of the connection that you want to deactivate.

A grey sliding switch indicates that the respective connection is deactivated.

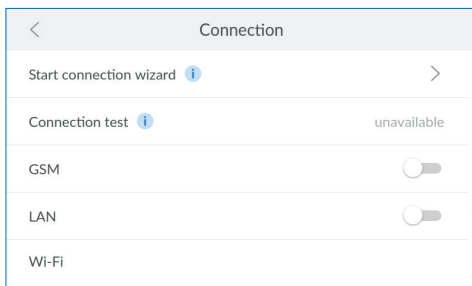

## 9.5 Checking the connection status

In addition to detailed information about your product, you will find further information about the current status of the device and connections in the **Info** menu.

Info	
Home	Operating record >
Settings	Serial no. / PNO >
Functions	Consumption >
Help	Connection status >
Login	Device status >

Connection status	
Active connection	-
GSM	Poor signal
LAN	10.1.8.20 -
Wi-Fi	192.168.110.1 -

### Connection information

 > Info

▶ Press **Connection status**.

### Connection status

Depending on your active connections, the following information is displayed:

- Actively used Internet connection
- GSM signal strength
- LAN IP address
- IP address / Wi-Fi signal strength

#### NOTE



- ▶ If neither LAN nor Wi-Fi is activated, the default IP address is used.
- ▶ Use this default IP address for Wi-Fi if you want to operate the product as an access point with a mobile device from outside (see chapter [“12.2 Remote operation of the product via a direct Wi-Fi connection \(access point\)”](#), page 58).

Benefits of registering ✕



Access to water hardness database hydromaps



Software updates



Troubleshooting functions



Use of the app: BWT Best Water Home



Current messages



Remote operation

**START REGISTRATION**

## 10 Registration

Registering the product enables many additional functions. While these functions have no influence on the hydraulic function of the product, they nevertheless offer great added value.

You can only use all of the manufacturer services if you register your product:

- Access to the water hardness database
- Regular software updates
- Troubleshooting
- Use of the BWT Best Water Home app
- Current messages
- Remote operation

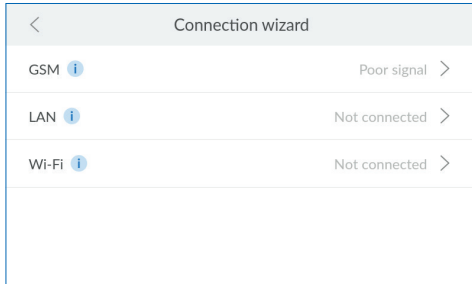

## 10.1 Starting registration on the product

### Subsequent registration

You can begin registration at any time:

 > Settings > Registration

### Selecting the connection type

- ▶ Select the connection type used by the product to connect to the Internet.
- ▶ Refer to the related chapter for more information on the selected connection type:
  - [“9.1 GSM – connection wizard”, page 27](#)
  - [“9.2 LAN – connection wizard”, page 29](#)
  - [“9.3 Wi-Fi – connection wizard”, page 31](#)

If you do not want to connect the product to the Internet, press **X** in the header to exit the connection wizard.

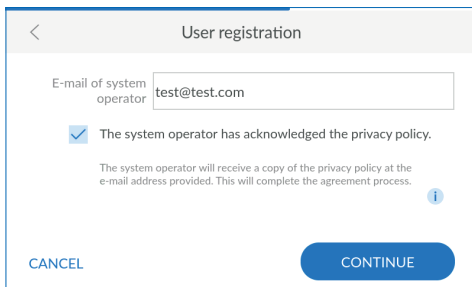

### Entering the e-mail address

- ▶ Tap inside the text box. A keypad is displayed.
- ▶ Enter your e-mail address.
- ▶ Check the box to confirm that you have read and understood the privacy policy.
- ▶ Press **CONTINUE**.
- ▶ Enter your e-mail address again. Double entry eliminates input errors.
- ▶ Press **CONTINUE**.

< Enter postcode

Country Deutschland

Postcode 69198 - Schriesheim

District Schriesheim

CANCEL CONTINUE

### Entering the postcode

Entering the postcode will automatically determine the water hardness from the **hydromaps** water hardness database for the installation location of your product.

- ▶ Tap inside the text box. A keypad is displayed.
- ▶ Enter the postcode of the installation location of your product and press Enter to confirm your entry.

### Selecting the district

- ▶ Select your district if applicable.
- ▶ Press **CONTINUE**.

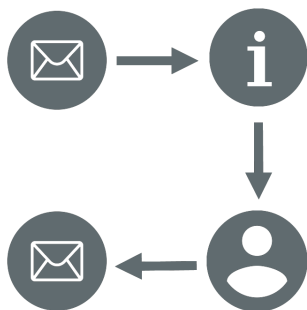

## 10.2 Completing registration online

### Confirming product registration/activation

You will receive an e-mail several minutes after entering your e-mail address.

- ▶ Click or press the **Activate product now** button in the e-mail.

Your web browser is opened where you can finish registration.

### Entering device information

You can specify individual device information, such as device name and device location.

- ▶ Read and confirm the privacy policy.
- ▶ Provide information about your product.
- ▶ Create a user account.

### Creating a BWT user account

You must create a user account to complete product registration. If you already have a user account, you may use it here.

- ▶ Enter your details and create a user account.

### Confirmation of successful registration

If registration was completed successfully, you will receive an e-mail with the following information:

- Important links for downloading the app
- Login data for remote operation
- Links to customer service and the online shop
- ▶ Make sure that you save this e-mail or print it out.

## 11 Operation

You can see current data and information as well as make settings in normal operation.

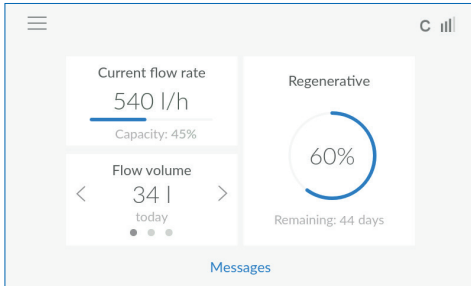

### 11.1 Home screen

You can see the current status of the product at a glance:



- **Current flow rate:** Current flow rate of outlet water (softened water plus inflow water) in litres per hour. The device output is displayed as a percentage below this.
- **Regenerative:** Estimation of the time remaining until the regenerative in the container is depleted. The estimation is displayed as a percentage and days remaining. The regenerative level is measured via ultrasound.
- **Flow volume:** Flow volume of fully softened water (soft water) in litres.

▶ Select < or > to switch between daily, monthly and annual consumption.

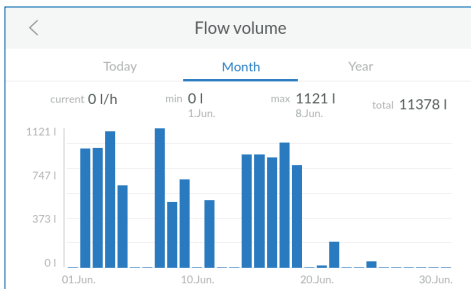
▶ Press the number of litres under **Flow volume** to open a graphic display of the flow volume.



Current messages		
	Regenerative 05.01.2021 09:46	Refill
	Wireless sensor no. 1 05.01.2021 09:59	Reset
	Tank 1 regenerated 05.01.2021 09:59	Confirm

	<b>Information</b>
	<b>Warning</b>
	<b>Fault</b>

## 11.2 Messages

► Press **Messages** on the home screen to display current device messages.

### NOTE



► If a message is confirmed without fixing the cause, this message appears again after the next regeneration at the latest.

Messages are divided into three categories:

- **Information** indicates events.  
Example: **Column regenerated**
- **Warning** indicates required actions.  
Example: **Refill the regenerative**
- **Fault** indicates mechanical, hydraulic or electronic problems.  
Example: **AQA Guard Wireless Sensor triggered**

► Fix the causes of warning and fault messages, and then acknowledge the messages on the display.

All messages are saved and can be viewed in the operating record:

 > Info > Operating record



### 11.3 Menu overview

You can open the menu overview either with the **Home** button from any of the menus, or with the button on the Home screen.

► Open the menu overview:

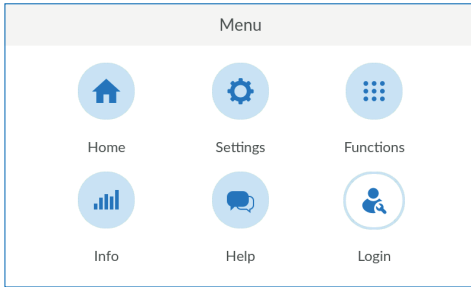

Home > 

The menu overview is the starting point for all other menus:

- **Home:** Current state of the product (see chapter "[11.1 Home screen](#)", page 39).
- **Settings:** Settings, external modules and registration (see chapter "[11.4 Settings](#)", page 41).
- **Functions:** Trigger actions (see chapter "[11.5 Functions](#)", page 46).
- **Info:** Operating record, product information and device status (see chapter "[11.6 Info](#)", page 52).
- **Help:** Contact persons and FAQs (see chapter "[11.7 Help](#)", page 56).
- **Login:** Login for service technicians.

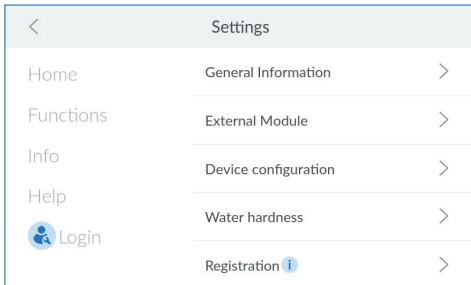

### 11.4 Settings

The **SETTINGS** menu provides access to the following options:

- **General Information:** Basic settings such as time, language, function times and connections
- **External Module:** Connection of additional external filters and modules
- **Device configuration:** Optional settings such as AQA Watch, Rinse or acoustic alarm
- **Water hardness:** Setting of inflow and outlet water hardness and unit for measuring the water hardness
- **Registration:** Online product registration and additional functions

General Information	
Date and time	14.12.2020, 11:53 >
Language	English >
Function times <i>i</i>	>
Connection	>
Screensaver	starts after 5 min >

### 11.4.1 General Information

You can set the date, time, language, function times, connection and screen saver in the **GENERAL INFORMATION** menu.

- ▶ Press > for the menu item in which you wish to change the settings.
- ▶ Press < or > to make the desired settings.
- ▶ Follow the instructions on the display.

External Module	
Filter	>
AQA Guard Wireless Sensor	>

### 11.4.2 External Module

If you have a connected external filter, select the type here and set whether you want to be notified as soon as it needs to be flushed or replaced.

You can connect up to 10 wireless sensors via the EnOcean interface. The sensors must go through the teach-in process on the product.

- ▶ Press > for the menu item in which you wish to change the settings.
- ▶ Press < or > to make the desired settings.
- ▶ Follow the instructions on the display.

AQA Guard Wireless Sensor		
Sensor 1	<input type="text" value="Please enter"/>	teach-in
Sensor 2	<input type="text" value="Please enter"/>	teach-in
Sensor 3	<input type="text" value="Please enter"/>	teach-in
Sensor 4	<input type="text" value="Please enter"/>	teach-in
Sensor 5	<input type="text" value="Please enter"/>	teach-in

### Teaching-in the AQA Guard Wireless Sensor

- ▶ Select a sensor and press **Please enter**.
- ▶ Enter a name for the sensor.
- ▶ Press **teach-in**.
- ▶ Pull the red test switch on the back of the sensor three times.

The teach-in process for the sensor is complete.

### Removing the AQA Guard Wireless Sensor

- ▶ Select the sensor to remove and press **Remove**.
- The connection to the sensor is deleted.

Device configuration	
AQA Stop Sensor <i>i</i>	<input checked="" type="checkbox"/>
AQA Stop Litre <i>i</i> 9999 l	<input checked="" type="checkbox"/>
AQA Watch <i>i</i>	<input checked="" type="checkbox"/>
Rinse <i>i</i>	<input type="checkbox"/>
Hygiene <i>i</i>	<input type="checkbox"/>

### 11.4.3 Device configuration

Depending on your product and the installed software, additional device settings are possible. You can activate/deactivate these settings as required.

► Press the checkbox(es) to activate or deactivate functions.

#### AQA Stop Sensor

If the product's floor sensor detects water on the floor, the water supply in the direction of flow behind the product is shut off and a warning is issued. The floor sensor only responds to drinking water (minimum conductivity of 500  $\mu\text{S}/\text{cm}$ ).

- Fix the cause of moisture on the floor.
- Dry the floor and the sensor.
- Acknowledge the message (see chapter "[11.2 Messages](#)", page 40).

#### AQA Stop Litre

To minimise water damage, the control valve can shut off the water supply downstream of the product. To do so, specify the water volume at which it should be shut off following continuous flow. Select this water volume so that your usual water consumption is not affected.

- Press the number to change the water volume.
- If the **AQA STOP LITRE** function has been triggered:
- Acknowledge the message (see chapter "[11.2 Messages](#)", page 40).

If a large amount of water is tapped without interruption, you can switch off the **AQA STOP LITRE** function for a short period of time by deactivating the checkbox.

Device configuration	
AQA Watch ⓘ	<input checked="" type="checkbox"/>
Rinse ⓘ	<input type="checkbox"/>
Hygiene ⓘ	<input type="checkbox"/>
Audible alarm	<input type="checkbox"/>
External Antenna	<input checked="" type="checkbox"/>

### AQA Watch

Consistently low flow rates indicate problems in the pipeline network. The **AQA WATCH** function monitors the domestic water network for low flow rates (< 60 l/h) and issues a warning as soon as they persist for more than 10 minutes.

### Rinse

The Rinse function provides an additional rinsing function that is recommended for operation with subsequent reverse osmosis (e.g. during operation of a steam generator).

- ▶ Activate this function during operation of the related products.

### Hygiene

The Hygiene function triggers the rinsing of the exchanger column if no water has been tapped for a period of 24 hours.

### Acoustic alarm

In case of a fault, an audible alarm sounds.

- ▶ Deactivate this function if you do not need it (e.g. because the product is out of earshot).

### External antenna

If reception is poor, you can connect an external GSM antenna.

- ▶ Activate this function if you have connected an external antenna.

< Water hardness

Determined inflow water hardness (according to postcode)

Enter value manually > 20 °dH

Select desired outlet water hardness

Luxury Water *i*  manual 4 °dH

FINE ADJUSTMENT

### Setting the water hardness

For registered products, the inflow water hardness is taken from the **hydromaps** water hardness database. Check that the database value matches the water hardness at the installation location and adjust the value for the inflow water hardness if necessary.

- ▶ If necessary, press **ENTER VALUE MANUALLY**.
- ▶ Enter the water hardness at the installation location.

#### NOTE





- ▶ The water hardness cannot be changed during regeneration.
- ▶ When setting the outlet water hardness, ensure that the maximum permissible sodium concentration of 200 mg/l in accordance with the German Drinking Water Ordinance is not exceeded.

- ▶ Select the desired outlet water hardness (luxury water with approx. 4 °dH), or enter it manually.
- ▶ Follow the instructions on the display.

To finely adjust the desired water hardness, proceed as follows:

- ▶ Press **FINE ADJUSTMENT**.

< Set motorized blending

Reduce hardness  Increase hardness 

3200  970 *i*

CANCEL (reset to previous position) SAVE

### Setting motor blending

If the outlet water hardness deviates, it can be finely adjusted in the “Set motorized blending” screen.

The impulse value within the gear wheel corresponds to fully opened blending. The value below the gear wheel reflects the current position of blending.

- ▶ After adjusting your setting, press **SAVE**

Benefits of registering ✕

 Access to water hardness database hydromaps

 Software updates

 Troubleshooting functions

 Use of the app: BWT Best Water Home

 Current messages

 Remote operation

START REGISTRATION

### 11.4.4 Registration

To be able to use all the additional functions, you must register your product (see chapter “[10 Registration](#)”\_ page 35).

<	Functions	
Home	Regeneration/rinsing	>
Settings	Return to operation	>
Info	Refill operating materials	>
Help	Holiday mode	>
 Login	Maintenance	>

## 11.5 Functions

The **FUNCTIONS** menu provides access to the following options:

- **Regeneration/rinsing:** Manually trigger regeneration or rinsing (e.g. after a holiday).
- **Shutting down/return to operation:** Shut down the product correctly.
- **Refill operating materials:** Confirm the refilling of regenerative.
- **Holiday mode:** Switch the product to standby mode for a defined period of time to save resources and prevent damage.
- **Maintenance:** Product check and maintenance routine with the **BWT IOCLEAN** cleaning tablet.

### 11.5.1 Regeneration/rinsing

You can trigger manual regeneration or rinsing at any time while the product is in operation.

- ▶ Press **Regeneration/rinsing** >.
- ▶ Select whether you want to trigger an additional regeneration or additional rinse.
- ▶ Press **Execute** to start the regeneration or rinse.

#### NOTE



▶ Note that once regeneration or rinsing has been started it takes a certain amount of time and must not be interrupted.

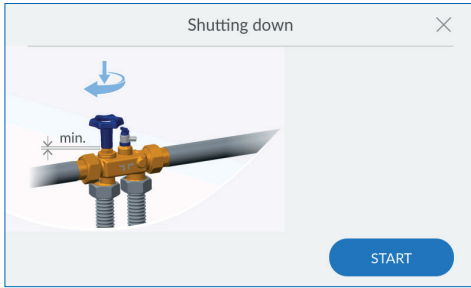

### 11.5.2 Shut down/return to operation

If you do not need the product for a longer period of time (e.g. you are away), you should shut it down.

As long as the product is in operation, the **Shutting down** menu appears. If the product was shut down, then the **Return to operation** menu appears.

#### Shutting down

- ▶ Press **Shutting down** >.
- ▶ Close the connection fitting.
- ▶ Press **Start**.

A valve on the product is opened and pressure is released.

#### Return to operation

- ▶ Press **Return to operation** >.
- ▶ Open the connection fitting.
- ▶ Press **Start**.

A valve on the product is closed and the pressure required for operation is generated.

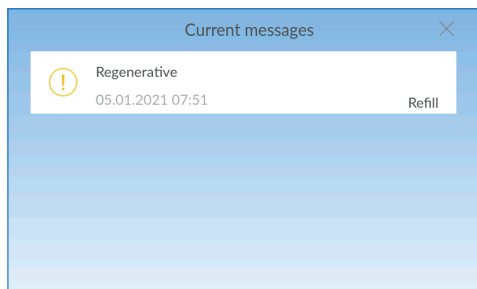

### 11.5.3 Refilling operating materials

#### >Functions > Refill operating materials

The regenerative must be refilled on a regular basis. The product monitors the regenerative supply with a sensor and reports a shortfall via the display. All commonly available regeneratives that comply with DIN EN 973 type A, can be used.

- ▶ Press lightly on the Easy Fill technology cover to open it (see chapter “[7.1 Opening the Easy Fill technology cover](#)”, page 19).
- ▶ Refill regenerative into the regenerative container. The maximum level of 100% on the display corresponds to a filling level of approx. 46 cm.

**Caution:** Do not fill with water!

- ▶ Press the Easy Fill technology cover down gently until it snaps shut.

#### NOTE



- ▶ When filling the regenerative, make sure that impurities do not get into the regenerative container and locking mechanism (red circle).
- ▶ If necessary, clean the regenerative pack in advance.
- ▶ If you notice impurities in the regenerative container, clean it with drinking water.
- ▶ Overfilling past the 100% mark can result in implausible fill level values being reported. Remove regenerative in case of overfilling.
- ▶ The product must not be operated with Sanitabs or Sanisal.

If the regenerative has been refilled, it must be confirmed in order to trigger ultrasonic measuring of the product.

Either:

- ▶ Press **CONFIRM** in the **Regenerative refilling** window.

Or:

- ▶ Press **REFILL** in the **Messages** window.

The device status display starts flashing to indicate that the regenerative level is being measured (see chapter “[7.2 Device status display](#)”, page 19).



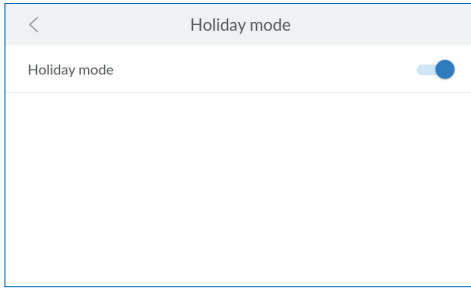

### 11.5.4 Holiday mode

If you do not need the product for a certain amount of time (e.g. during holidays, etc.), switch it to Holiday mode. Holiday mode is a standby mode that conserves resources and reduces the risk of water damage:

- Regeneration does not take place, which saves water and regenerative.

#### Activating Holiday mode

☰ > Functions > Holiday mode

- ▶ Press the sliding switch to activate Holiday mode.

#### NOTE



- ▶ You can activate Holiday mode on the product or via the app. However, you can only deactivate it on the product.
- ▶ If you have already gone on holiday and forgotten to activate Holiday mode, use the BWT Best Water Home app or remote operation to switch on Holiday mode.

#### Deactivating Holiday mode

☰ > Functions > Holiday mode

- ▶ Press the sliding switch to deactivate Holiday mode.

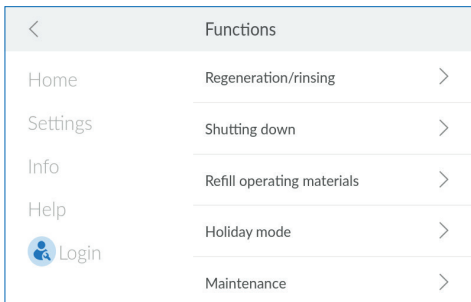

### 11.5.5 Maintenance

The product is equipped with a maintenance function that must be activated twice a year. You will be guided via the display in checking the basic functions.

☰ > Functions > Maintenance

#### NOTE



- ▶ No maintenance can be performed during the regeneration procedure.
- ▶ If necessary, wait until regeneration is complete.

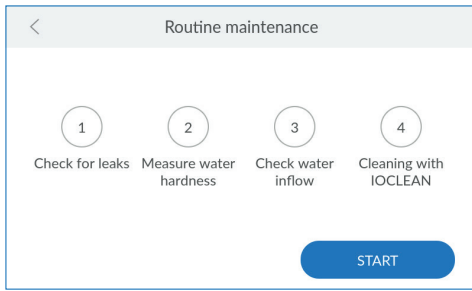

► Press **START**.

You will be guided step-by-step through the maintenance procedure.

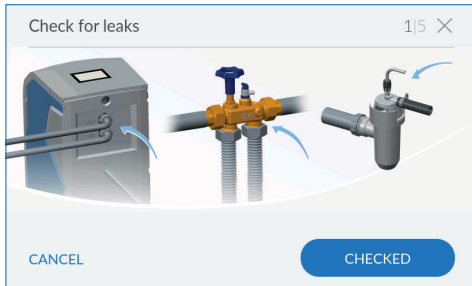

### Checking for leaks

In this step, check the system for leaks.

► Check the product as well as the connections both in front of it and behind it for leaks.

#### NOTE



► Pay particular attention to water leakage at the screw connections (arrows in the picture).

If you did not find any leaks:

► Press **CHECKED**.

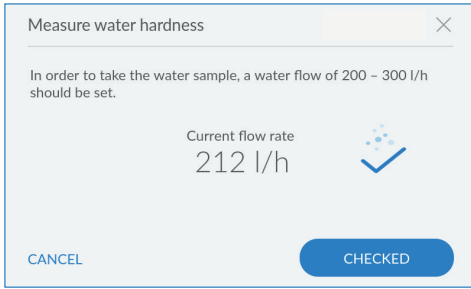

## Measuring water hardness

To determine the water hardness, take a water sample at the nearest sampling point at a flow rate of 200 to 300 l/h.

► Press **CHECKED**.

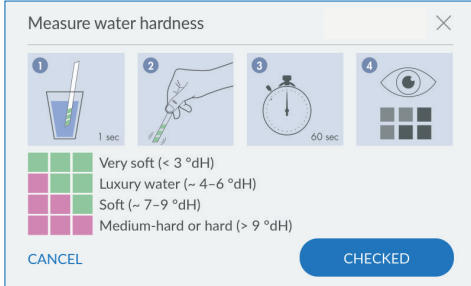

► Check the outlet water hardness with the enclosed luxury water check.

## NOTE



► Follow the usage instructions enclosed with the luxury water check.

If the water hardness is acceptable:

► Press **CHECKED**.

If the water hardness is not acceptable:

Press **CANCEL**, readjust the motor blending and repeat the water hardness test (see section [“Setting the water hardness” on page 45](#) and [“Setting motor blending” on page 45](#)).



## Checking the water inflow

► Check whether the water inflow to the product is correct.

► Press **CHECKED**.



## Cleaning

Cleaning is the last step in the biannual maintenance of your product. Only use the **BWT IOCLEAN** cleaning tablets for this.

- ▶ Open the Easy Fill technology cover of the product.
- ▶ Take a cleaning tablet out of the packaging and insert it into the opening provided on the product (see the adjacent image).
- ▶ Press **PERFORMED**.

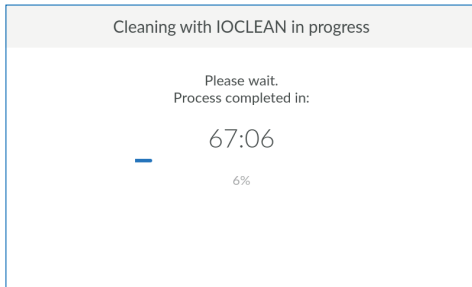

Cleaning starts and the remaining time until the end of the rinsing procedure is displayed.

**NOTE**



- ▶ During cleaning, no settings can be made on the product.
- ▶ Wait until regeneration is complete.

The Home screen is displayed once the cleaning process is complete.

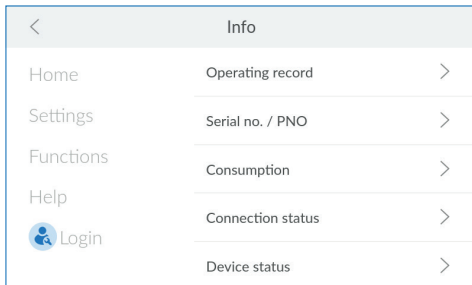

## 11.6 Info

The **INFO** menu provides access to the following options:

- **Operating record:** Documentation of all messages and events
- **Serial no. / PNO:** Product-specific information
- **Consumption:** Information about water and regenerative consumption
- **Connection status:** Information about the type and quality of existing connections
- **Device status:** Information about softened water capacity and regeneration progress

Operating record	
08.01.2021 15:15 [6]	Power failure
11.01.2021 07:04 [7]	Power restored
11.01.2021 07:43 [71]	Tank 1 regenerated

### 11.6.1 Operating record

☰ > Info > Operating record

You can view all events in the operating record, such as power failures, regenerations and other errors, with the date, time and frequency.

- ▶ If necessary, swipe your finger upwards from the bottom of the display to scroll through the list.
- ▶ Press > next to an entry for more details.

Serial no. / PNO	
Serial number	SCH062018027968/6-500138
Start-up data	24.06.2020 14:04
Product Code	U8QJ-G8PV
BWT Connect	2.0008
PCB 1.0	2.0.5

### 11.6.2 Serial no. / PNO

☰ > Info > Serial no. / PNO

The product-specific information is required to enable after-sales service to quickly check how up-to-date your product and the installed device software are, if necessary.

- **Serial number:** Individual serial number
- **Start-up data:** Time of start-up
- **Product Code:** Individual product code
- **BWT Connect:** Version of the installed device software
- **PCB:** Printed circuit board installed in the product
- **Unit:** Product designation

▶ If necessary, swipe your finger upwards from the bottom of the display to scroll through the list.

Serial no. / PNO	
Product Code	U8QJ-G8PV
BWT Connect	2.0008
PCB 1.0	2.0.5
PCB 1.1	2.0.5
Unit	BWT Perla

#### NOTE



▶ Make note of this data on the inside cover of this manual so that it is quickly accessible in case service is required.

Consumption	
Flow volume	>
Regenerative	>
Water consumption	>

### 11.6.3 Consumption

☰ >Info > Consumption

▶ Press > for detailed information about the flow volume, regenerative or water consumption.

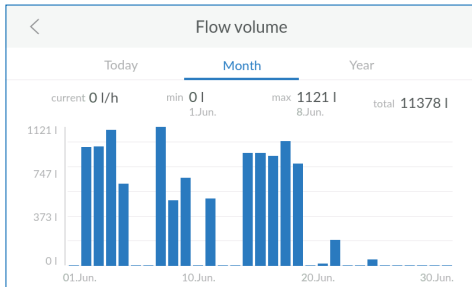

#### Flow volume

Information about the current water flow.

▶ Press TODAY, MONTH or YEAR to view the flow volume in the respective time period.

#### NOTE



▶ A maximum flow rate that is too low indicates a problem in the pipe system.

Regenerative	
Since 21.05.2020 (Start-up)	25.1 kg
Since 21.05.2020 (Maintenance)	25.1 kg
Since refill	10.2 kg
Σ regenerations since start-up	33 n
Σ regenerations since maintenance	33 n

#### Regenerative

Information about current regenerative consumption.

▶ If necessary, swipe your finger upwards from the bottom of the display to scroll through the list.

Water consumption	
Wednesday	49 l
June	11378 l
2020	12.1 m <sup>3</sup>
Since 21.05.2020 (start-up)	12.1 m <sup>3</sup>
Since 21.05.2020 (maintenance)	12.1 m <sup>3</sup>

#### Water consumption

Information about current water consumption.

▶ If necessary, swipe your finger upwards from the bottom of the display to scroll through the list.

Connection status		
Active connection		-
GSM		Poor signal
LAN	10.1.8.20	-
Wi-Fi	192.168.110.1	-

#### 11.6.4 Connection status

 > Info > Connection status

In addition to displaying the connection currently being used, you can also view information about the quality, status and IP addresses of all connection types.

Device status	
Remaining capacity	672 l
Start Regeneration	<a href="#">Execute</a>
Regeneration step	Operation
Regeneration time remaining	0 s
Brine meter – Current suction rate	0 ml/s

#### 11.6.5 Device status

 > Info > Device status

Information about the remaining softened water capacity and current regeneration step.

- ▶ Press **EXECUTE** to start regeneration manually if required.
- ▶ Swipe your finger upwards from the bottom of the display to scroll through the list.

Device status	
Regeneration step	Operation
Regeneration time remaining	0 s
Brine meter – Current suction rate	0 ml/s
Brine meter – Amount last extracted	0 ml
Flow	0 l/h

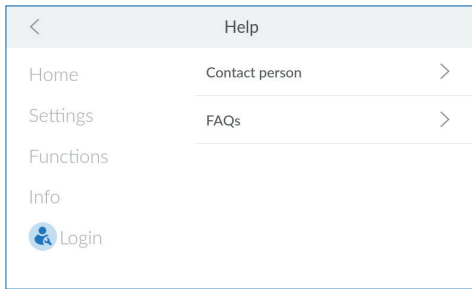

## 11.7 Help

The **HELP** menu provides access to the following options:

- **Contact person:** Information about the installation specialist and service
- **FAQs:** QR code for the Internet page with answers to frequently asked questions

### 11.7.1 Contact person

Enter the contact data for after-sales service here so that it is handy in case of a fault.

- ▶ Type into the individual text fields and enter the respective contact data.



### 11.7.2 FAQs

FAQs are answered and published on the manufacturer's Internet page.

- ▶ Use the QR scanner on your mobile device to open the FAQs page.

#### NOTE



- ▶ All questions and answers can also be found on the related product page at [www.bwt.com](http://www.bwt.com).



## 12 Additional functions

Registering your product allows you to use various additional functions. For an overview of the benefits of registering, see chapter [“10 Registration”](#), page 35.



### 12.1 BWT Best Water Home app

The BWT Best Water Home app offers a clear overview of your products.

#### Features of the BWT Best Water Home app

- Monitoring the regenerative level
- Service information
- Holiday mode
- Warning and fault messages
- Direct communication with your BWT drinking water specialist
- Regular newsletters and promotions relating to your BWT products are available on request



#### NOTE



► The product data is not displayed in real time.

### Installing the BWT Best Water Home app

- ▶ Open the **Apple App Store** or **Google Play Store** on your mobile device.
- ▶ Search for **BWT BEST WATER HOME**.
- ▶ Install the **BWT BEST WATER HOME** app and then open it.
- ▶ Select **ADD BWT PERLA** and log in with your BWT user account (e-mail address and password).

#### NOTE



▶ You can only be logged in with one account. Always use the same account to activate all your BWT products.

Your BWT product is now integrated into the **BWT BEST WATER HOME** app and can be used.

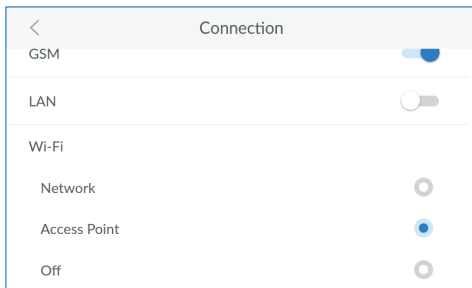

### 12.2 Remote operation of the product via a direct Wi-Fi connection (access point)

Activate this function to operate your product via a direct Wi-Fi connection (access point) on a mobile device.

- ▶ Open the connection settings:

☰ > **Settings** > **General Information** > **Connection**

- ▶ Press **ACCESS POINT**.

Wi-Fi with the **BWTAP** SSID is displayed.

- ▶ Enter the WPA2 key that you received via e-mail when you registered the product.

## Establishing a direct Wi-Fi connection

### NOTE



▶ A direct Wi-Fi connection (access point) is only possible within a close vicinity to the product.

▶ Note the WPA2 key and login code from the e-mail you received when registering your product.

- ▶ Activate the **ACCESS POINT** function on the product.
- ▶ Search for Wi-Fi with the **BWTAP SSID** on your mobile device.
- ▶ Enter the WPA2 key received via e-mail.
- ▶ Open a web browser on the mobile device.
- ▶ Enter the IP address of the Wi-Fi provided by your product into the address bar in the browser.

### NOTE



▶ **Checking the IP address:** The default IP address is 192.168.110.1. You may need to check the product to see if a different IP address is being used (Info > Connection status menu).

A connection to the product is established.

- ▶ Enter the login code that you received during registration via e-mail.
- ▶ Operate your product via the direct Wi-Fi connection in the same way as you would via the display on the product.

## 12.3 Remote operation of the product via the home network (LAN / Wi-Fi)

You can operate the product remotely if it is connected to the home network via LAN or Wi-Fi.

### NOTE



- ▶ While operating the product via remote connection, you must not change this connection, otherwise access is no longer possible.
- ▶ The product and mobile device must be in the same network.
- ▶ To enable data transfer, the following port must be open on your router: TLS / SSL port 443

### Requirements

- The product was successfully registered.
- The login code you received after registration is available.
- The connection via LAN or Wi-Fi is active and working.
- ▶ Open a web browser on a device connected to the network.
- ▶ Enter the IP address of the product into the address bar in the browser. You can find this information here:



> Info > Connection status

- ▶ Confirm your entry.
- ▶ Enter the login code received via e-mail to establish the connection.

A connection to the product is established.

- ▶ Operate your product via the remote connection in the same way as you would via the display on the product.

### NOTE



- ▶ While operating the product via remote connection, you must not change this connection, otherwise access is no longer possible.
- ▶ Holiday mode can only be activated via remote connection, not deactivated.

## 13 Operator responsibilities

You have purchased a product that is durable and easy to service. However, certain duties must be carried out. Flawless function requires:

- Operation as intended
- Regular checks and servicing

Check the quality and pressure conditions of the inflow water regularly with your water supplier. If the water quality changes, the settings may need to be changed. Consult a specialist in this case.

To ensure the proper functioning and safety of the product, regular inspections must be carried out by the operator (every 2 months), and routine maintenance (EN 806-5) must be performed by the BWT after-sales service staff or a fitter authorised by BWT to carry out maintenance (every 6 months).

The replacement of wearing parts within the prescribed intervals is also required for the warranty and proper functioning of the unit.

### 13.1 Intended operation

The intended operation of the product includes commissioning, operation, decommissioning and, if necessary, recommissioning. Intended operation of the product and drinking water installation requires regular checks, servicing and operation (water flows through the product) in accordance with the operating conditions for design and construction, including simulated sampling (manual or automated flushing), where appropriate. If simulated sampling is not possible, the product must be taken out of service.

## 13.2 Checks

### (Carried out by the operator)

BWT recommends that the operator regularly carry out the following checks and record the results:

- Water quality: Depending on the product, inflow water values and set outlet water values may need to be corrected.
- Water pressure: If the pressure conditions change, the product settings may also have to be changed.
- Operating condition of the product.
- Check whether messages have been issued.
- Leak-tightness of the product and installation.

### 13.3 Inspection

(carried out by the operator in accordance with EN 806-5)

Performing the inspection is obligatory for you as an operator if you use your outlet water as described in category 1 (see table).

Use of outlet water	Category	Inspection in accordance with EN 806-5	Maintenance in accordance with EN 806-5
Direct or indirect, targeted supply of drinking water in the context of a rental or other independent, regular activity carried out with the intention of making a profit.	1	<b>Obligatory</b>	Implementation by specialist only  <b>Obligatory</b>
Supply of drinking water for an undetermined, changing group of people not connected by personal relationships.	1	<b>Obligatory</b>	Implementation by specialist only  <b>Obligatory</b>
<b>No</b> direct or indirect, targeted supply of drinking water in the context of a rental or other independent, regular activity carried out with the intention of making a profit.	2	<b>Not obligatory</b>	Implementation by specialist or operator  <b>Not obligatory</b>
<b>No</b> supply of drinking water for an undetermined, changing group of people not connected by personal relationships.	2	<b>Not obligatory</b>	Implementation by specialist or operator  <b>Not obligatory</b>

### 13.3.1 Inspection activities

The scope of required inspection activities is more limited if your product is registered with BWT and you use the available options (see table):

- BWT Best Water Home app
- Download, check and archive device documentation from the app

This is the only way to directly detect and act on necessary actions or mechanical/hydraulic/electrical problems.

Inspection activities	Interval	Instruction for products WITHOUT online registration	Instruction for products WITH online registration
Check/refill regenerative	According to use	Required	Required
Check brine containers for soiling	Every 2 months	Required	Required
Check for leaks, visual inspection	Every 2 months	Required	Required
Functional test/control unit display	Every 2 months	Required	Not required
Test regenerative consumption depending on the treated water	Every 2 months	Required	Not required
Check the setting of the regeneration waste water system	Every 2 months	Required	Required
Check the counting function of the water meter	Every 2 months	Required	Not required
Test the regeneration process	Every 2 months	Required	Not required
Clean the brine container and the internal surfaces that come into contact with water	Every 6 months	Required	Required

### 13.4 Maintenance in accordance with EN 806-5

(carried out by BWT after-sales service or an authorised technician in accordance with EN 806-5)

In addition to all inspection activities, maintenance work on the assemblies listed below is required every 6 months by BWT after-sales service or a specialist trained by BWT. A detailed maintenance manual can be requested from the qualified fitter at BWT. We recommend that you enter into a maintenance agreement with the BWT after-sales service department or your fitter.

**Depending on the type and design of the BWT product, the following assemblies are provided and must be cleaned and sanitised as required:**

Entire hydraulic unit
End shield
Gears
Drive motor
Control piston
Red/green injector
Electrolysis cell
Locking pin
Waste water elbow
JG hoses
Blending
Water meter cover
Paddle-wheel
Guide baffle
Check valve
Bypass valve
Filler plug
Brine meter
Brine meter solenoid valve
AQA Stop floor sensor
BWT AQA test



### 13.5 Replacement of parts

The operator must ensure that parts that are subject to wear and ageing during the life of the product are replaced by a qualified fitter.

Details of the replacement cycles can be found in the maintenance manual from BWT.

### 13.6 BWT expert maintenance

Regardless of how the outlet water is used, the manufacturer recommends having expert maintenance performed at least every 24 months.

### 13.7 Stoppages and re-activating the unit

<b>In case of expected stagnation phases, take the following preventive measures:</b>	<b>BWT recommendations for restarting a unit after stagnation phases:</b>
Fewer than 3 days: None	Start-up rinse of the product. Then open all taps to rinse the system.
3 to 30 days: Use the controller to put the product in Holiday mode. For information about activating Holiday mode, see chapter " <a href="#">Holiday mode</a> " on page 49.	For information about deactivating Holiday mode, see chapter " <a href="#">Holiday mode</a> " on page 49.
1 to 6 months: Close the connection fitting and shut down the product via the controller. Then remove the mains plug.	Open the main shut-off valve and connection fitting. Have BWT after-sales service perform a regeneration of the exchanger column using Dioxal disinfectant. Then open all taps to rinse the system.
Longer than 6 months: Disconnect the building's water system from the municipal water system. Disconnect the product from the water supply system (close the connection fitting) and shut down the unit.	Reconnect the unit to the municipal drinking water system. Have BWT after-sales service perform a regeneration of the exchanger column using Dioxal disinfectant.

## 14 Troubleshooting

### 14.1 Fault during start-up

Fault	Possible source of the fault	Steps to resolve the fault
1 Fault when activating the product	1.1 Were all mandatory fields completed?	If all fields are complete and the e-mail address has been entered correctly, follow step 1.2.
	1.2 Is the product connected to the Internet?	Check the product's Internet connection using the reception bars on the top right of the display. If no GSM connection is established, follow the steps to connect the product to the home network (see chapter "9.2 LAN – connection wizard", page 29 or "9.3 Wi-Fi – connection wizard", page 31). If a connection is established, follow step 1.3.
	1.3 Is there a success report in the message overview?	Check whether the following message is displayed in the messages (menu <b>Home &gt; Messages</b> ) on the product: <b>Registration successful – check incoming e-mail</b> . If you do not find this message, start the activation process again. If you find the message, follow step 2.1.
2 Fault when delivering the activation message	2.1 Has sufficient time passed?	Activation of your product may take up to an hour. If after this period you have not received an activation e-mail to the address you have provided, follow step 2.2.
	2.2 Is the e-mail address correct?	Check that the e-mail address you entered on the product is correct and amend it if necessary. If the e-mail address is correct, follow step 2.3. If an incorrect e-mail address was entered during the initial entry, start the registration process again.
	2.3 Is the e-mail in a spam folder?	Check the spam/junk mail folder of the e-mail address provided. If you cannot find an activation e-mail there, start the activation process again.
	2.4 Have you carried out the activation again?	If you have already carried out the activation again, but the problem persists, please contact the BWT service hotline (after-sales service). Keep the product code handy for this ( <b>Info &gt; Serial no. / PNO</b> menu).
3 Fault during online activation	3.1 Website does not open when you click on the activation link.	Check the Internet connection of the product on which you wish to open the link. Online activation can only be performed when the Internet connection is active.
	3.2 Website opens with a service message (maintenance)	Occasionally, maintenance of the systems must be performed. During these periods, activation is not possible. Try again after the specified maintenance period.
	3.3 Website opens with a fault message (service request not available (any longer))	To guarantee security, activation links have an expiration date. This date was exceeded. Restart product activation.

	3.4 User account creation not possible (maintenance message)	Occasionally, maintenance of the systems must be performed. During these periods, activation is not possible. Try again after the specified maintenance period.
	3.5 User account creation not possible (fault message – input)	Check that the entries in the mandatory fields are correct.
	3.6 User login not possible (maintenance message)	Occasionally, maintenance of the systems must be performed. During these periods, activation is not possible. Try again after the specified maintenance period.
	3.7 User login not possible (fault message)	Check the e-mail address and password for accuracy. Make sure the Caps Lock key on your keyboard is not activated. Also check the language of the keyboard you are using and make sure that this matches your desired input language.
	3.8 User login not possible (forgotten password)	Click <b>Forgotten password</b> and follow the process to set a new password.
	3.9 It is not possible to complete the activation (input fields incomplete)	Check the input fields. All mandatory fields must be filled with correct values.
	3.10 Complete the activation (consent to data protection agreement)	Read the data protection agreement carefully and confirm your agreement. Use of digital services is only possible with consent.
4 Fault after successful start-up	4.1 Product does not yet show in the <b>Settings &gt; Registration</b> menu that the registration was successful even though the activation process was successful. (E-mail confirmation of successful activation received)	It can take up to an hour for the product to successfully activate. If this period has already expired, contact the service hotline (after-sales service).

## 14.2 Fault during operation

Fault	Cause	Remedy
Low regenerative indicator is shown.	Insufficient regenerative in the regenerative container (3).	Refill the regenerative (see chapter <a href="#">“11.5.3 Refilling operating materials”</a> , page 48).
	If there is still regenerative in the container, regenerative encrustation may have formed under the ultrasound sensor.	Loosen and stir the regenerative.
The product is not supplying softened water.	No regenerative in the regenerative container (3).	Refill the regenerative (see chapter <a href="#">“11.5.3 Refilling operating materials”</a> , page 48). Trigger regeneration manually for exchanger column.
	Power supply interrupted.	Establish electrical connection.
	Blending not set correctly.	Set blending (see section <a href="#">“Setting the water hardness”</a> on page 45).
	A cavity prevents enough brine from being formed (“salt bridge”).	Ensure that the regenerative is filled evenly without cavities. If the regenerative level is low, “stir” the regenerative with a suitable object.
The product supplies deviating outlet water hardness.	The product has not been finely adjusted.	The outlet water hardness still has to be finely adjusted.
	Water hardness of the inflow water has changed.	Adjust the water hardness of the inflow water.
The product is not supplying softened water or the flow is insufficient.	Inlet pressure is too low.	Increase inlet pressure (set pressure reducer if necessary) and start manual regeneration.
Coloured rinsing water at start-up.	Abrasion particles from exchanger resin are flushed out.	Start-up repeat rinsing (see section <a href="#">“Rinsing procedure”</a> on page 26).
An implausible fill level is displayed.	The regenerative container is filled past the 100% mark.	Remove any excess regenerative so that the regenerative container is filled up to the 100% mark at most.
The product cannot be registered. The product cannot be connected to a network. The product cannot be added to the BWT Best Water Home app.	Lack of connectivity	Check for faults during start-up (see chapter <a href="#">“14.1 Fault during start-up”</a> , page 66). If the cause cannot be found, contact after-sales service (see chapter <a href="#">“15.1 Product returns”</a> , page 70).

If the fault cannot be remedied by following these instructions, contact our after-sales service department.

You will need the serial number and production number, which can be found on the type plate of the Easy Fill technology cover. Keep these numbers handy when you contact after-sales service.

### 14.3 Faults affecting the additional functions

Fault	Possible source of the fault	Steps to resolve the fault
1 Fault when downloading the app	1.1 Link does not work	Check the Internet connection and the availability of the required app store on your smartphone. Try again. Make sure you have a QR code reader installed on your smartphone.
	1.2 Installation not possible (Android or iOS)	Check the version of your smartphone operating system. This must correspond to a supported version.
	1.3 Installation not possible	Unfortunately, your operating system is not supported.
2 Registration in the app	2.1 Unable to register in the app	Check the Internet connection of your smartphone. Registration is only possible with an existing Internet connection.
		Check the registration details and, if necessary, reset the password you have chosen.
		Occasionally the servers have to be maintained. In this case, a service message is displaying indicating a time period for the maintenance. Try again after the time period has expired.
	2.2 Product is not displayed	Did you activate the product successfully? You will receive the e-mail confirming successful activation after completion of the activation process. If this is not the case, contact after-sales service.
	2.3 Device status and app do not match	Please check the Internet connection of your product and also make sure that your smartphone is connected to the Internet.
		After activation for the first time or during operation, the status is calibrated just once a day via GSM. As a result, there may be deviations.
		If the deviations persist over a period of several days, contact after-sales service.
	2.4 You did not receive an execution message after triggering an action (Holiday mode, rinse, regenerate).	Triggering an action can take up to one hour. If this period has expired, check the Internet connection of your product and your smartphone. If an Internet connection is available and the period of one hour has expired, contact after-sales service.
	2.5 Holiday mode cannot be deactivated	For safety reasons, holiday mode can only be deactivated on the product itself. Make the setting on the product.

## 15 Warranty

If the product malfunctions during the warranty period, please contact your contract partner, the installation company, and indicate the model type and production number (see specifications or the type plate on the unit).

Non-compliance with the installation conditions and the responsibilities of the operator, as well as improper use leads to the loss of warranty and exclusion of liability.

### 15.1 Product returns

Product returns will not be processed without a return number (RMA no.). In Germany, call our after-sales service in Schriesheim to receive a return number.

Unauthorised returns of goods will not be accepted by BWT. Please always contact your contract partner first.

### 15.2 Your contact at BWT

You can reach us at the following number:

**Service acceptance** **+49 6203 7373**

Monday to Thursday: 6:30 a.m. to 6:00 p.m.



Friday: 6:30 a.m. to 4:00 p.m.

## 16 Decommissioning and disposal

### 16.1 Decommissioning

The product may only be shut down and dismantled by qualified specialists.  
Observe all applicable safety regulations when dismantling the system.

### 16.2 Disposal

NOTE	
	<ul style="list-style-type: none"><li>▶ This product may not be disposed of in household waste.</li><li>▶ At the end of the product's life cycle, ensure that it is properly disposed of or recycled.</li><li>▶ Observe the legal disposal guidelines for the country in which the product is used.</li><li>▶ The following materials are used in the product: metal, plastics, electronic components.</li></ul>
	

#### 16.2.1 Disposal of the transport packaging

Recycling the packaging materials saves resources and reduces waste. Return the packaging to your specialised dealer.

#### 16.2.2 Disposal of old devices

Do not dispose of the old device in household waste. Use the official municipal collection and returns facilities for electrical and electronic waste or return the device to your dealer. By law, you are responsible for deleting any personal data on the old device before disposal.

#### 16.2.3 Disposal of old batteries

Batteries must never be disposed of in household waste. Batteries not sealed inside the device must be removed and brought to a suitable collection point (such as your dealer) for disposal free of charge.

## 17 Technical data

Softening unit	Type	BWT Perla home	BWT Perla one
Nominal connection width	DN		32
Connection type			G 1 1/4"
Nominal capacity in accordance with DIN EN 14743 min./max.	mol (m <sup>3</sup> x °dH)		1.6 (9)/3.2 (18)
Capacity/kg of regenerative in accordance with DIN EN 14743 min./max.	mol		4.2 / 6.1
Peak flow when blending from 20 °dH to 0 °dH	m <sup>3</sup> /h	See chapter " <a href="#">17.2 Diagram of peak flow</a> ", page 74	
Operating flow when blending from 20 °dH to 0 °dH	m <sup>3</sup> /h		1.7
Nominal flow in accordance with DIN EN 14743	m <sup>3</sup> /h		1.7
Nominal pressure PN	bar		10
Min./max. operating pressure	bar		2 to 8
Pressure drop at operating flow	bar		1.0
Area of application according to DIN 1988-200	Residential units People		1 to 5 2 to 12
Ion exchange material fill quantity	l		6.2
Supply of regenerative, max.	kg		32
Regenerative consumption per 100% regeneration, approx.	kg		0.76
Rinsing water consumption per 100% regeneration at 4 bar, approx.	l		40
Rinsing water flow during regeneration, approx.	l/h		200
Duration of 100% regeneration in ion exchange tank, approx.	min.		45
Water temperature, min./max.	°C		5 to 25
Ambient temperature, min./max.	°C		5 to 40
Humidity			Non-condensing
Power supply	V / Hz		100 – 240 / 50 – 60
Unit voltage	VDC		24
Power during operation	W		5.6
Power during regeneration, max.	W		40
Fault message output, max.	VDC / A		24 / 0.5
Protection class			IP54
Operating weight if filled to max.	kg		76
Shipping weight, approx.	kg		32

**For the production number, see the label on the title page of this manual and the type plate under the Easy Fill technology cover of the product.**



## 17.1 Dimensions

Designation			BWT Perla home	BWT Perla one
Height	A	mm	797	
Width	B	mm	394	
Depth	C	mm	505	
Water inlet connection height	D	mm	592	
Water outlet connection height	E	mm	652	
Overflow connection height	F	mm	410	
Clearance to allow the technology cover to be opened	G	mm	400	
Min. sewage system connection		DN	40	

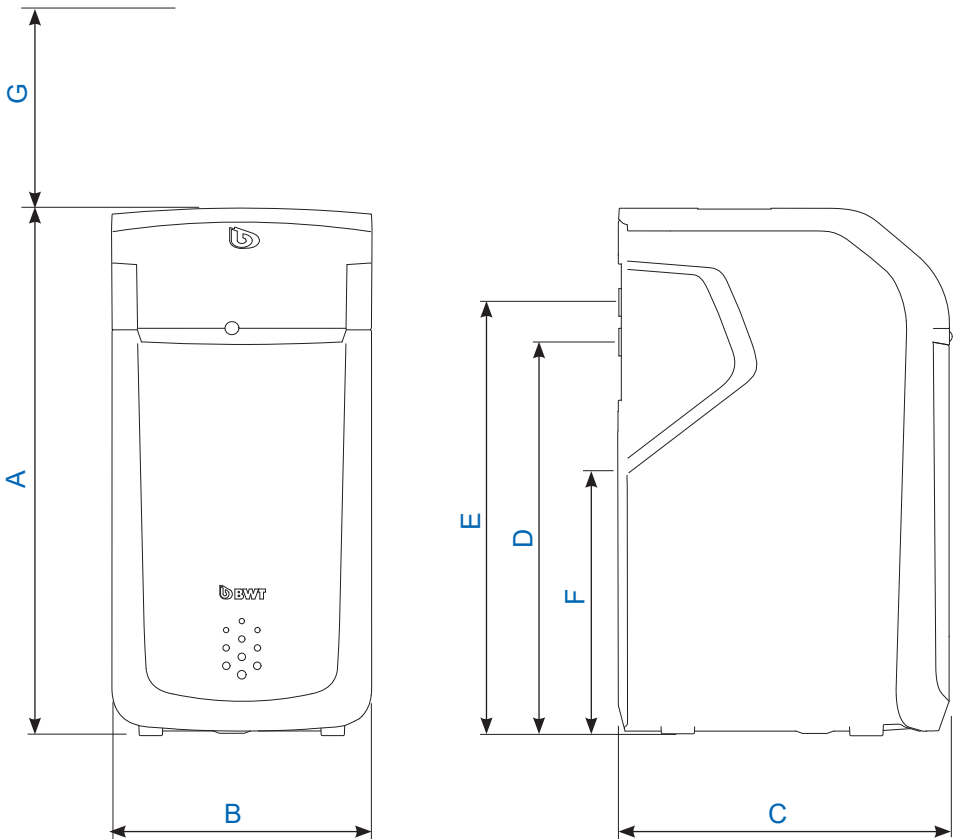

## 17.2 Diagram of peak flow

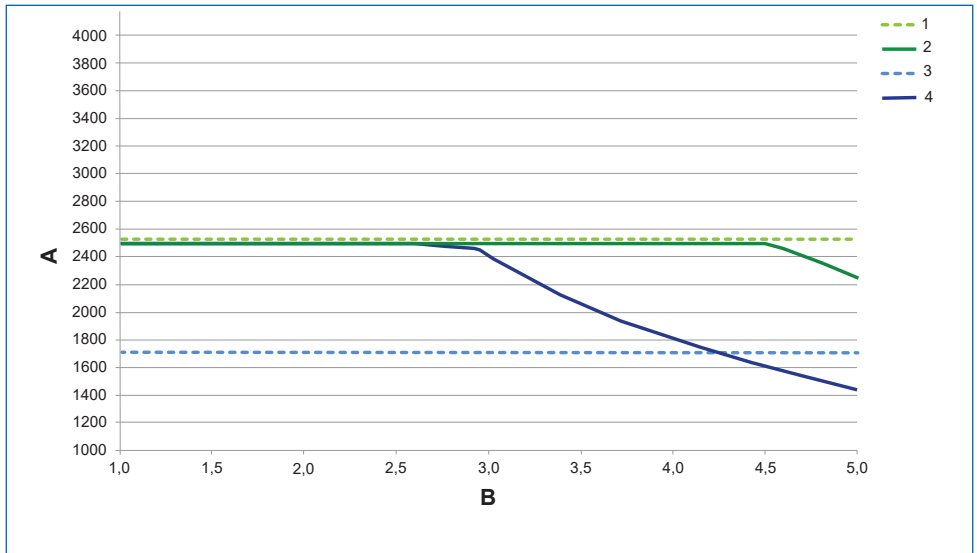

<b>A</b>	Peak flow [l/h]
<b>B</b>	Inflow water hardness [mmol/l]
1	2 bar pressure loss
2	BWT Perla home/one max. capacity
3	1 bar pressure loss
4	BWT Perla home/one min. capacity

mmol/l	°dH
1.0	5.6
1.5	8.4
2.0	11.2
2.5	14.0
3.0	16.8

mmol/l	°dH
3.5	19.6
4.0	22.4
4.5	25.2
5.0	28.0

### Peak flow

The peak flow is the flow rate at which the product's outlet water hardness value is reduced to values less than 10% of the inflow water hardness for at least 10 minutes. The pressure difference may rise to greater than 1 bar.

### Operating flow

The operating flow is the flow rate on which independent testing institutions based their capacity testing (see DIN EN 14743 for details).

### Nominal flow

The nominal flow rate is the volume flow at which the product causes a pressure drop of 1 bar at a water temperature of 15 °C when the blending is closed.

## 18 Standards and legal provisions

**Standards and legal provisions shall always be applied in the most recent version.**

The following standards and legal regulations must be observed depending on the intended use:

- German ordinance on the quality of water for human consumption (“Trinkwasserverordnung”)
- EN 806, Specifications for drinking water installations
- DIN 1988 standards, specifications for drinking water installations
- DIN EN 1717, protection of drinking water from contaminants in the drinking water supply system
- DIN EN 15161, Water conditioning equipment inside buildings – installation, operation, maintenance and repair

**The product meets the following standards:**

- DIN EN 14743, Water conditioning equipment inside buildings – softeners
- DIN 19636-100, Water softeners (cation exchangers) for drinking water installation – Part 100: Requirements for use of softening units in accordance with DIN EN 14743.



## Information in accordance with section 16 and section 21 of the German Drinking Water Ordinance

The drinking water in this building is treated as followed:

Type of treatment:  Partial softening  
 Metering

Product designation: \_\_\_\_\_

Installation location of the product: \_\_\_\_\_

**Metering of silicate substances**

For minimising the corrosiveness of drinking water and preventing elevated concentrations of heavy metals

**Silicate concentration of your water, approx.** \_\_\_\_\_ mg/l

Max. permitted addition in accordance with the German Drinking Water Ordinance: 15 mg/l

(calculated as SiO<sub>2</sub>)

**Metering of phosphate substances**

To minimise liming, corrosiveness of drinking water and to prevent elevated concentrations of heavy metals

**Phosphate concentration of your water, approx.** \_\_\_\_\_ mg/l

Max. permitted addition in accordance with the German Drinking Water Ordinance: 2.2 mg/l

(calculated as P)

**Metering to set the pH value**

For minimising the corrosiveness of drinking water and preventing elevated concentrations of heavy metals

**pH value of your water** \_\_\_\_\_

Limits in accordance with the German Drinking Water Ordinance: greater than 6.5 and less than 9.5

**Metering of sodium hypochlorite or chlorine dioxide solution**

To increase sanitary properties of drinking water

Chlorine or  chlorine dioxide concentration  
of your water, approx. \_\_\_\_\_ mg/l

Max. permitted addition in accordance with the German Drinking Water Ordinance: 0.3 mg/l chlorine or 0.2 mg/l chlorine dioxide

**Partial softening of drinking water by sodium ion replacement**

To minimise liming

Hardness range of your water:  Soft (less than 8.4 °dH)  
 Moderate (8.4 °dH – 14.0 °dH)

**Sodium concentration of your water, approx.:** \_\_\_\_\_ mg/l

Max. permitted concentration in accordance with the German Drinking Water Ordinance: 200 mg/l

Company: \_\_\_\_\_

Date of last maintenance: \_\_\_\_\_

## A Appendix

### A.1 Connection set, DN 32/32 DVGW



#### A.1.1 Intended use

The corrugated hoses with G 1 1/4" internal threads may only be used to connect water softeners.

Corrugated hoses ensure a strain-free connection to the water softener. They eliminate the time-consuming process of adapting and fitting metal pipes for this purpose.

#### A.1.2 Installation conditions

Corrugated hoses are only suitable for drinking water installations. The chloride content of the water must not exceed 250 mg/l.

Corrugated hoses must not be shortened.

Never strain or twist the corrugated hoses during installation. Do not try to fold or squeeze them.

The minimum bending radius of the hoses is 50 mm.

The corrugated hoses are not to come into contact with plaster, cement, salt or other corrosive materials.

Do not install the corrugated hoses in water. The outer surface must remain dry.

Both ends of the hose must have access to air for the installation.

If necessary, the corrugated hoses can be insulated against splash water. Make sure the hoses are dry when attaching the insulation covering.

The space between the corrugated hoses and the insulation covering must be free of any air pockets.

Non-compliance with the installation conditions and the operator responsibilities voids the warranty.

## A.1.3 Installation

Failure to follow the installation instructions will adversely affect the product life of the hoses and void the warranty in the event of damage.

### A.1.3.1 Installation instructions

The straight path **A** must measure at least 30 mm.

The bending radius **R** must be at least 50 mm.

Never twist or pull the corrugated hoses.

During installation and the period thereafter, the hoses must not be subject to any external pressure or elongation.

► Only use matching spanners for the hexagon nuts. Do not use a pipe wrench!

► Join the water softener and connection fitting using both corrugated hoses and seal the connections.

Hose for hard water (outgoing arrow on the connection fitting, ingoing arrow on softener).

Hose for soft water (outgoing arrow on the softener, ingoing arrow on the connection fitting).

#### Note:

According to DIN 1988, the flushing water and overflow hoses must be connected to the sewage water system at least 20 mm above the highest waste water level (unimpeded drainage).

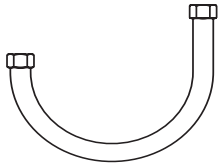
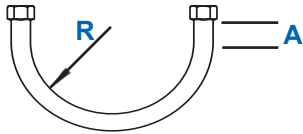

**correct**



**correct**

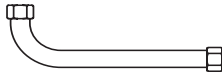

**correct**

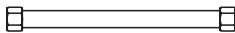

**correct**



**correct**

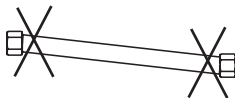

**wrong**

## A.2 Installation set for water softeners

The installation set complies with the requirements of standard EN 1717.

- ▶ If necessary, put the rubber sleeve (1) on the DN40 pipe as shown.
- ▶ Place the coupling nut with the sealing ring (2) on the pipe and screw it to the siphon.
- ▶ Position the overflow hose connection (3) at least 20 mm below the height of the overflow point of the water softener.
- ▶ Route the rinsing water hose with an incline to the connection (4) and push it in by 90 mm.
- ▶ Route the overflow hose from the regenerative container to the connection (1), attach it and secure it with a hose clamp.

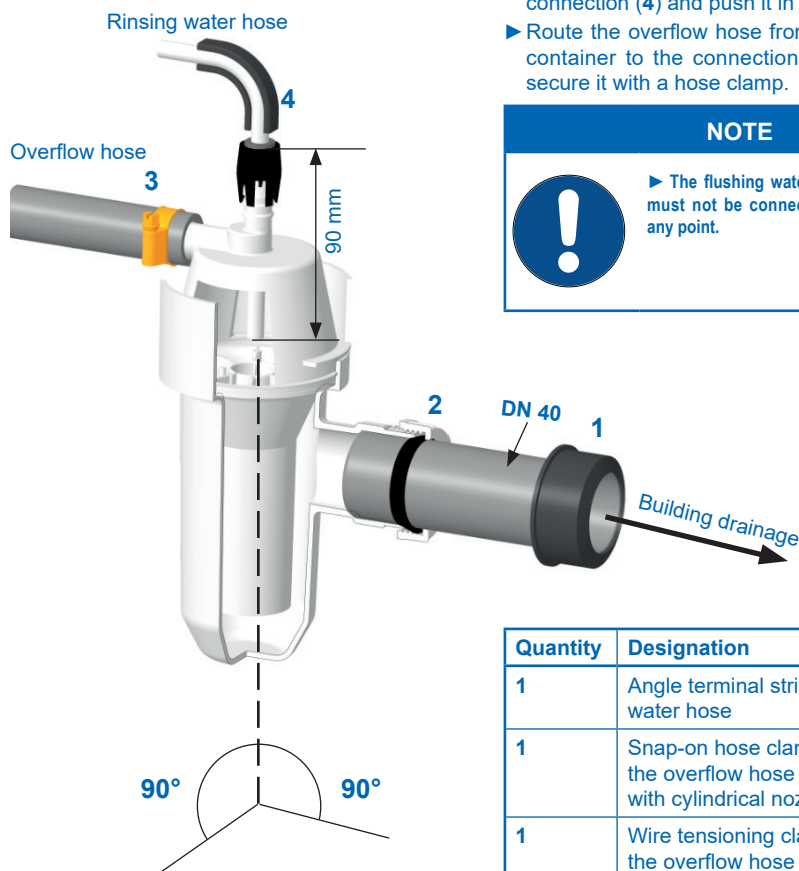

### NOTE



▶ The flushing water and overflow hoses must not be connected or constricted at any point.

Quantity	Designation
1	Angle terminal strip for the rinsing water hose
1	Snap-on hose clamp for attaching the overflow hose to the container with cylindrical nozzle
1	Wire tensioning clamp for attaching the overflow hose to the container with conical nozzle
4	Flat gaskets for corrugated hoses



# EU-Konformitäts-Erklärung

## EU Declaration of Conformity

### UE Certificat de conformité

im Sinne der Richtlinien	Maschinen	2006/42/EU
	Niederspannung	2014/35/EU
	EMV	2014/30/EU
	RoHS	2011/65/EU
according to the directives	Machinery	2006/42/EU
	Low voltage	2014/35/EU
	EMC	2014/30/EU
	RoHS	2011/65/EU
en accord avec les directives	Machines	2006/42/UE
	Basse tension	2014/35/UE
	CEM	2014/30/UE
	RoHS	2011/65/UE

Produkt/Product/Produit: **Simplex Trinkwasserbehandlungsanlage**  
**Simplex softening unit**  
**Simplex systèmes d'adoucissement d'eau**

Typ/Type/Type: **BWT Perla**  
**Baureihe / series / série de modèles**

ist entwickelt, konstruiert und gefertigt in Übereinstimmung mit den oben genannten Richtlinien, in alleiniger Verantwortung von

is developed, designed and produced according to the above mentioned guidelines at the entire responsibility of

est développé, conçu et fabriqué en accord avec les instructions mentionnées ci-dessus sous l'entière responsabilité de

**BWT Wassertechnik GmbH, Industriestr. 7, 69198 Schriesheim**

(WEEE-Reg.-Nr. DE 80428986)



Schriesheim, Dezember 2020  
Ort, Datum / Place, date / Lieu et date

Lutz Hübner  
Unterschrift (Geschäftsleitung)  
Signature (Management)  
Signature (Direction)

## Further information:

### **BWT Holding GmbH**

Walter-Simmer-Straße 4  
A-5310 Mondsee

Phone: +43 / 6232 / 5011 0

E-Mail: [office@bwt.at](mailto:office@bwt.at)

### **BWT Wassertechnik GmbH**

Industriestraße 7  
D-69198 Schriesheim

Phone: +49 / 6203 / 73 0

E-Mail: [bwt@bwt.de](mailto:bwt@bwt.de)